



Manufacturer & Exporter of Surgical & Dental Instruments.



Dental Instruments Catalogue

Smile Surgical is a leading manufacturer and exporter of all kinds of single use and reusable Surgical & Dental instruments to worldwide. Our manufacturing unit is located at Sialkot (Pakistan), a world's renowned city for the manufacturing of Surgical & Dental Instruments. This is our family business, so we have worked hard to build our reputation in this evolving industry and our satisfied customers are our strength.

Our products are manufactured by using the best quality stainless steel as **AISI, ASTM** and **DIN** standard's recommended which is imported from **Germany, Japan** and **France**. All of the Surgical & Dental Instruments supplied by us are **ISO 9001:2015, ISO 13485:2012** and **CE** marked certified in accordance with the Medical Devices Directive. The key to our success is our quality assurance. We use the right material for the right products. We are also **OEM (Original Equipment Manufacturer)** and provide customise packaging to our customers.

We have vast range of different instruments available in our stock ready to be shipped for fast delivery to our valuable customers. By using the traditional craftsmanship and latest precision technologies, we are able to manufacture the instruments that are compatible and compete with the highest standards and quality of international markets. **Smile Surgical** is strongly determined to provide a dedicated service to customers that is built on foundations of quality and cost effectiveness.

Smile Surgical prices are very competitive and very flexible with customers provide maximum co-operation. Our company's motto is to keep customers satisfy because your satisfaction is our business.

Our Mission At Smile Surgical

1. To provide our customers with outstanding customer support and provide premium quality Surgical & Dental instruments at the best and competitive prices.
2. To provide our customers with friendly support, easy-to-use ordering system.
3. To provide our customers with the latest products available.

Our Policy At Smile Surgical

1. To be the market leader in supplying the best and premium quality Surgical & Dental instruments at highly competitive and affordable prices.
2. Fully understand the requirements of our respected customers and satisfy them.
3. Strongly follow the policy "**Customer First**" and "**Quality First**"
4. To continuously develop our technical expertise on the basis of technology, customer's feedback and quality workforce

5. To form strategic joint ventures and distribution networks within the industry around the globe and to fulfill our social, ethical and industrial obligations in the most effective and efficient manner.

Our Strategy At Smile Surgical

- 1) It is our utmost priority to serve our valuable customers with fair dealing, honesty, sincerity, truth, trustworthy relationship and cooperation.
- 2) We always cordially welcome our valuable customer's opinions, suggestions and recommendations.
- 3) We give replacement against defective goods, if the malfunction occurred at our end.
- 4) The stainless steel used in the production of purchase order is exactly the same as per approved samples.
- 5) Normally for cutting instruments like Scissors, Knives etc. we use (AISI 420 Grade) premium quality stainless steel.
- 6) For non-cutting instruments like Forceps, Tweezers, Impression Trays etc. we use (AISI 410 & AISI 304 Grade) premium quality Stainless Steel.
- 7) Moreover, we can use also the material as per our customer's requirements and demand.

If you would like to get our price list, interested to see our samples for quality assessment, would like to be our distributor or want to get more information about our premium quality instruments, please feel free to contact us for any information.

Thank you very much for your precious time and looking forward to get business from you.

Best Regards
Director
Smile Surgical

Quality Management System

The quality policy is the main guiding principles that provide the focus of quality to the whole organization and improve the effectiveness of the quality management system.

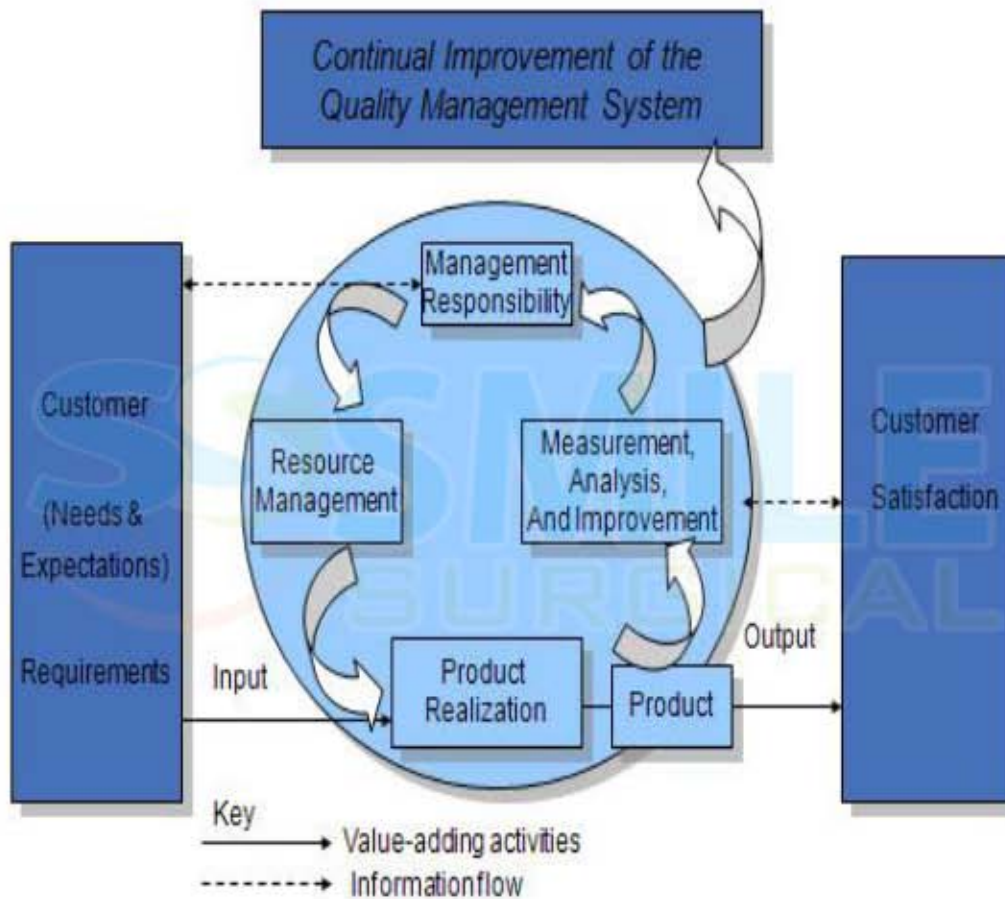

Quality Begins With People Who Care



Manufacturing Capabilities Of Smile Surgical

All of our production departments are well equipped with the latest machinery which is imported from **Germany** and **England** and are well-staffed with the expert technicians.

Raw Material Department

Smile Surgical always purchases best quality stainless steel raw material from steel suppliers or import directly from **Japan**, **France** and **Germany** when need to do. Different grades of stainless steel for example **(303, 304, 410, 420 & 440)** are used in the production of our Surgical & Dental Instruments.

At Smile Surgical, we believe that quality can only be achieved through quality raw material. As such, the best quality raw-materials (Stainless Steel Strips, Round Bars, Stainless Steel Coils and Stainless Steel Tubes) are purchased and are subjected to composition and hardness testing through our in-house laboratory in order to ensure that only the best materials are passed on to production departments.

ASTM Standards

Smile Surgical fully follows and complies with the international **ASTM Standards** during the manufacturing of instruments. Below mentioned are the references and lists of the standards that we follow:-

- 1) **Smile Surgical** acquires premium quality stainless steel for the manufacturing of Surgical & Dental Instruments as per **ASTM Standard F899-95 and ISO 7153**.
- 2) Descaling and cleaning of stainless steel in conformity to **ASTM Standard A380-99**.
- 3) Passivation of Surgical & Dental Instruments in conformity to **ASTM Standard B967-05**.
- 4) Corrosion of Surgical & Dental Instruments in conformity to **ASTM Standard F1089-02**.
- 5) Electro-polishing of Surgical & Dental Instruments in conformity to **ASTM Standard B912-02**.
- 6) As different instruments are manufactured with different grades of stainless steel. We mostly use the stainless steel type **AISI-303, AISI-304, AISI-410, AISI-420, and AISI 440** series with defined specifications as per customer's requirements. Therefore, in order to select the proper grade of stainless steel, various processes are followed according to the guidelines and conformity of **ASTM Standards**.

Forging Department

Smile Surgical has its own forging section where forgings are made through Drop Hammer process by seasoned operators using dyes made of the best quality imported D-2 Steel. Forging is done by keeping in mind that the geometry of this process is a starting point and does not on any way limit your design freedom.

Milling Department

Milling is used in the Surgical & Dental instruments industry, defined as the process of cutting, shaping and finishing of an instrument. It is the process that includes turning, welding and fringing. At **Smile Surgical** we use the best milling technology which involves cutting away pieces of metal to create dovetails, threads, bevels, slots and ridges.

Grinding: (Filing & Setting)

In order to give a final shape to the instrument, our highly skilled craftsman use filing and grinding processes which removes the material from the instrument by abrasion. Then the instrument is keenly observed and set to perform perfect.

Hardness Test (Heat Treatment)

For Surgical & Dental instruments, the term harness refers to the resistance to bending, scratching, abrasion or cutting. We have in-house Heat Treatment Department equipped with top quality Vacuum Furnace where qualified staff and engineers are engaged in treating the instruments in order to add strength to the steel and perfect the metallurgical composition for further processes. 50-55 hardness rating is applied to each instrument during the heat treatment process in order to increase the strength of instruments.

Polishing Department

The Electro-polishing Department is manned by seasoned workmen using imported chemicals and best quality grinding wheels to ensure the best quality finish. In this department at **Smile Surgical**, the instruments are given final finish which includes mirror, satin or matt finishes. The finish is per customer's requirements.

Tungsten Carbide Department

Smile Surgical's tungsten carbide department is installed with the best quality imported machinery being manned by the exceptionally well trained experts using the German Technology. We use German tungsten carbide tips for our instruments.

Coating Department

Our coating department is capable of providing gold plated instruments as well as powder coated instruments depending upon the requirements of the instrument or the customer. Best quality coating related raw materials are used so that no compromise can be made on quality. Furthermore, each coating is inspected for quality before any instrument is passed on to the next department.

Passivation Department

We use high quality imported chemicals in our Passivation Department. Every instrument is boil test and passivate for 24 hours before move to the next department. If need arises, the instruments are re-passivated so as to eliminate any chances of rusting or corrosion during the life of the instrument. Our instruments are rust-free for life though we give guarantee for five years.

Sandblasting Department

For sandblasting of our instruments, we use the machines as well as the best quality sandblasting material, which are operated by skilled & well trained operators.

Stamping/Etching

We use permanent and long life high quality laser etching which produces a wide variety of text and graphic images including our customer's logo with very detailed and fine image quality.

Quality Control Department

Our quality control department is involved at all of the processes of manufacturing but before the instrument goes to the packing department, its quality and function is thoroughly checked by our qualified engineers.

Labeling and Packing

Each instrument is initially packed in a poly bag to prevent scratches and then packed in the middle box. Middle boxes are then packed in the carton. The middle boxes are labeled which includes the article number, types and sizes of instruments. We can also arrange packaging and labeling according to the customers demand.

Warehouse/Stock Room

After the instruments are packed and labeled, cartons are then move to our in-house warehouse where the complete record of shipments are maintained by our qualified warehouse management.

Terms and Conditions Of Business

Company's Agreement

Smile Surgical believes in the highest moral values and business ethics. Once a contract is made with a customer, we strongly aim at following it in its true spirit regarding the quality of product, packing, delivery time or any other particular need of the importer.

Prices

Our prices are stable for one year, after which they may be subject to a change depending upon general price increase of stainless steel. Instruments prices are revised according to the price of raw material and craftsmanship at the end of company's financial year.

Minimum Orders

We require a minimum order of US\$ 500.00 to process a delivery.

Payment Terms

With new customers, we require an advance payment of 100% for first six months. However, credit terms can be arranged according to the importers requirement after 6 months.

Freight & Shipping

Smile Surgical provides different methods of delivery as per customers demand:

- 1) By Air
- 2) By Sea
- 3) By Courier

Freight and shipping charges may be added to the invoice depending upon the nature of delivery unless otherwise stated by the importer. We deliver both C&F and FOB shipments.

Returns Policy

A great deal of effort is made on packing your order with great care. Please inspect the instruments thoroughly for any loss or damage immediately upon delivery of products and file claim if products are found damaged. Concealed loss or damage must be reported within 5 days upon receipt.

Returns and Technical Support

No returns are accepted without prior notices. Please contact our customer service team to obtain your invoice number. We reserve the right to examine returned goods before issuing credit. Returns must be made as soon as possible. Our technical team will carry out all repairs quickly and reliably.

CARE, HANDLING AND STERILISATION OF INSTRUMENTS

Smile Surgical Approved Sterilisation Methods

We recommend steam autoclave and ethylene oxide (ETO) sterilisation methods. Steam autoclave is highly efficient method of sterilisation which will not dull sharpness of instruments. If steam autoclave and ethylene oxide methods are not available, dry heat and chemical vapour methods are also recommended. We don't approve chemical sterilisation methods. These methods destroy instruments quickly and if used will eventually invalidate the warranty of your instruments.

Sterilisation Advice

Instruments should be dry before sterilising and in the open position when sterilised. Instruments trays should never be overloaded. Sterilising units must be cleaned and functioning properly. Autoclaves have high levels of moisture can be damaging if not in good working order. Purified, distilled water must be used in autoclave sterilisation units. We don't recommend using tap water. It contains minerals which can cause corrosion and discolouration of instruments. Take out the instruments from the autoclave immediately after cooling when the sterilisation cycle is completed. Ensure that all tips and joints of the instruments are moisture free. Moisture may cause corrosion. Before storage, instruments should be properly lubricated with silicon based lubricant.

Cleaning of Instruments

Always clean the instruments thoroughly in order to enhance the life span of your instruments. Bulk debris should be removed immediately after use. We recommend Enzymatic Cleaning solution in an ultrasonic cleaner to clean the instruments. Ultrasonic solution must be changed on daily basis. Instruments with hinge must be cleaned in an open position. Oxidation and discoloration may occur if instruments are not thoroughly cleaned. Always use disinfectants and detergents which are suitable for use with Surgical & Dental instruments. With regards to concentration and length of exposure, detergent manufacturer's instructions should be followed strictly. Tap water should be avoided during the cleaning of instruments. It contains minerals which can cause corrosion and discolouration of instruments. Tap water can also neutralise the rust inhibiting and lubricating solution.

We recommend the use of purified, distilled water in ultrasonic cleaning units. It is also recommended to use non-rinse ultrasonic solution that contains both lubricant and rust inhibitor prior to sterilisation and follow the manufacturer's exact solution measurement. Never leave the instruments in the ultrasonic solution after the cycle is finished. Instruments should be removed and dried immediately.

Lubrication of Instruments

Instruments must be lubricated regularly to increase the life time of instruments. It should be carried out daily or at least on a weekly basis. Prior to sterilisation, instruments must be lubricated. Lubricants designed specifically for precision hinged instruments should be used. Make sure to use lubricant that is well-suited with the operating temperature of your dry heat unit if dry heat steriliser is being used.

Sharpening of Instruments

Regular sharpening of instruments for example cutters will enhance their service life and increase their ability to cut more effectively and efficiently. **Smile Surgical** recommends frequency of sharpening the cutters depends on how frequently you use them and also the diameters and type of wires in which the cutter is being used frequently. Cutters must be assessed regularly if sharpening is required.

Corrosion

All of the instruments manufactured by **Smile Surgical** are highly resistant to corrosion. Following care recommendations and maintenance tips can be followed to further prevent corrosion problems. Occasionally, discolouration of instruments may not be corrosion. Sometimes organic materials that are deposited on the instruments during use can give the appearance of corrosion or can be mistaken for rust.

- 1) An orange-brown stain is normally a phosphate layer caused by water sources, sterilisation solutions or cleaning detergents.
- 2) A black stain is normally an acidic reaction caused by detergents.
- 3) A dark brown stain is usually caused by dried blood residues.
- 4) A blue-black stain is usually plating caused by autoclave cleaning materials.

Corroded instruments should never be mixed with non-corroded instruments as it may multiply the process of oxidation. We strongly recommend discarding or replacing the corroded instruments immediately.

Prevention of Corrosion

Corrosion can be an issue with any stainless steel instrument. Stainless steel requires oxygen to form a chromium oxide surface layer, which prevents it from corrosion. Bonding agents, organic residue and water droplets left on the instruments prevents oxygen to come in contact with the surface of the instrument and forming this protective layer.

Smile Surgical Recommends The Following Steps To Prevent Corrosion

- 1) Prior to the sterilisation of instruments, all residual matter must be cleaned thoroughly.
- 2) Instruments must be sterilised in open position.
- 3) Instruments must be properly air or towel dried. Specifically take care of the joint areas and hinges.
- 4) Corroded instruments should never be sterilised with non-corroded instruments as it may permanently transfer the iron oxide on the corroded instruments to the non-corroded instruments.

Smile Surgical Final Recommendations

- 1) All RE-USABLE instruments are delivered in NON-STERILE condition and must be cleaned, lubricated and sterilised before every use.
- 2) All instruments should be disinfected and cleaned immediately after use with disposable cloth/paper/ wipes etc.
- 3) If the instruments come into contact with blood, tissue, physiological saline or other foreign substances, they should be rinsed with warm (not hot) water before the substance dries up on the instruments.
- 4) We recommend cleaning solutions and rinse with pH7.0.
- 5) Ultrasonic cleaning is recommended.
- 6) For effectiveness, first clean any residue off the instruments before placing them in ultrasonic cleaner.
- 7) After cleaning, all instruments should be dried immediately.
- 8) Treat all instruments with oil which is considered as being physiologically safe (paraffin oil), especially their ends, ratchets, and moveable parts.
- 9) Instruments can be disinfected in Thermal Washer disinfectors.
- 10) For the disinfection and cleaning of Titanium and Aluminium Instruments, only use the substances that are particularly suggested for Titanium and Aluminium Instruments.
- 11) For instruments manufactured with autoclavable plastic, place them in the middle of chamber to avoid the overheating of plastic and not along the walls of chamber. We recommend to sterilise these instruments by putting them in "Self Sealing Sterilisation Pouches".
- 12) Do not leave instruments in cleaning or disinfecting solutions for a long time (over night or weekend) otherwise instruments can be damaged.
- 13) All instruments should be visually inspected for damage or breakage.
- 14) It is the user's responsibility to take proper care of the instruments.
- 15) We recommend laying down all instruments in their primary packaging.
- 16) Vacuum autoclave (steam) is performed at the temperature of 134 °C.
- 17) If instruments are dry heat (hot-air) sterilised, the temperature should be between 180 °C to 190 °C.

- 18) Corroded instruments should be discarded immediately.
- 19) The instructions of the autoclave manufacturer must be observed and followed always.
- 20) Instruments must be stored in dry, clean and humidity free environment without direct solar radiation.
- 21) Protect pointed tips of instruments with cloth, gauze or a special protection tube available from Smile Surgical.

Maintenance of Instruments

Smile Surgical always recommend to follow proper handling, care and sterilisation methods in order to increase the life span of your instruments in order to make sure they perform the best that they can.

Note: Always Use The Cleaning & Disinfection Solutions/Substances That Are Particularly Suggested For Specific Type & Category Of Instruments And Follow The Manufacturer Instructions.

Type Of Instruments	Ultrasonic	Automatic Washer	Cold Disinfection Water Based	Cold Disinfection Alcohol Based	Autoclave 121 °C Saliva	Autoclave 134 °C Blood	Dry Heat Sterilisation
Stainless Steel / Titanium	✓	✓	✓	✓	✓	✓	✓
Non Anodized Aluminium & Titanium Coating	✓	✓	✓	✓	✓	✓	✓
Silicon & Autoclave Plastic	✓	✓	✓	✓	✓	✓	✓
Anodized Aluminium, Silver & Chrome Plated	✗	✗	✗	✓	✓	✓	✗
Brass & Polycarbonates	✗	✗	✗	✓	✓	✗	✗
Diamond Coated	✗	✗	✗	✓	✗	✗	✗
Non Autoclave Plastic	✗	✗	✓	✗	✗	✗	✗

01	EXTRACTING FORCEPS	01 to 71
02	ROOT ELEVATORS	72 to 102
03	DIAGNOSTIC, PERIODONTAL & RESTORATIVE INSTRUMENTS	103 to 197
04	MAXILLOFACIAL SURGERY INSTRUMENTS	198 to 248
05	ORTHODONTIC PLIERS & INSTRUMENTS	249 to 275
06	DENTAL IMPLANT INSTRUMENTS	276 to 314
07	IMPRESSION TRAYS	315 to 333
08	HOLLOW WARE INSTRUMENTS	334 to 342
09	INDEX	343 to 352

We, at SSMILE SURGICAL would like to say a

BIG THANK YOU

in advance for taking your precious time and browse through our New Edition of Dental Catalogue.

We are proud to present this Dental Catalogue to you and excited to introduce some new products.

There are lots of new, attractive and innovative designed Dental Instruments in this New Edition of our Dental Catalogue.

We focus on expressing our total commitment to perfection when it comes to production of either our Catalogue or our Dental Instruments.

Your Teeth Health Matters To Us.

We have tried our best to convey a message to our valuable customers, partners, colleagues and friends in business that our dental instruments are designed to enhance your teeth life so that you may continue with the beauty in life that it will bring.

PRECISION + PERSISTENCE = PERFECTION



Handle Selection For Extracting Forceps

The diagram illustrates the selection of extracting forceps based on the handle pattern required for different teeth. The upper and lower dental arches are shown with teeth numbered 1 through 48. Callout boxes provide lists of forceps numbers for each tooth. Below the arches, six forceps (A-F) are shown with their corresponding handle patterns: English Pattern, English Pattern with Anatomical Handle, American Pattern, Deep Grip Forceps with Hole Pattern, and Hole Pattern.

Upper Arch Callouts:

- Teeth 1, 2, 3, 4, 5, 6, 7, 8, 9, 10, 11, 12, 13, 14, 15, 16, 17, 18: 29,30,108,113
- Teeth 11, 12, 13, 14, 15, 16, 17, 18: 1,107
- Teeth 12, 13, 14, 15, 16, 17, 18: 7,17,44N,51, 52,53,65,89, 92,94,95,96
- Teeth 12, 13, 14, 15, 16, 17, 18: 7,18,44N,51, 52,53,65,90, 93,94,95,97
- Teeth 17, 18: 10,17, 19,67, 88,89,94
- Teeth 17, 18: 10,18, 19,67, 88,90,95

Lower Arch Callouts:

- Teeth 22, 23, 24, 25, 26, 27, 28, 29, 30, 31, 32, 33, 34, 35, 36, 37, 38: 22,23,24,73,79
- Teeth 22, 23, 24, 25, 26, 27, 28, 29, 30, 31, 32, 33, 34, 35, 36, 37, 38: 16,22,73, 79,86,89
- Teeth 22, 23, 24, 25, 26, 27, 28, 29, 30, 31, 32, 33, 34, 35, 36, 37, 38: 13,75
- Teeth 22, 23, 24, 25, 26, 27, 28, 29, 30, 31, 32, 33, 34, 35, 36, 37, 38: 13,74,75A
- Teeth 31, 32, 33, 34, 35, 36, 37, 38: 33,74,75A
- Teeth 160, 161: 160,161
- Teeth 123, 143: 123,143
- Teeth 123, 162: 123,162

Forceps and Handle Patterns:

- A:** English Pattern
- B:** English Pattern
- C:** English Pattern, Anatomical Handle
- D:** American Pattern
- E:** Deep Grip Forceps With Hole Pattern
- F:** Hole Pattern

Extraction Forceps

Dental forceps are pliers-like instruments that are used to grasp teeth.

A dentist will usually have a number of different ones on hand, each having a design that's tailored to:

The specific shape of the tooth it's intended to remove (such as incisors vs. molars having two roots vs. molars having three roots).

The location of the tooth in the mouth (such as front vs. back, or left lower molar vs. right upper molar.)

How they're used.

A dentist will grasp a tooth with their forceps and then firmly and deliberately rock it back and forth as much as it will.

Because the bone that surrounds the tooth is compressible, the socket will gradually start to expand.

As it does, the range of the dentist's side-to-side motions will increase.

In addition to this rocking motion, the dentist will also rotate the tooth back and forth.

This twisting action helps to rip and tear the tooth away from the ligament that binds it in place.

At some point, the socket will be enlarged enough, and the ligament torn away enough, that the tooth can be easily removed.



For Special Packing of Extracting Forceps Please Ask



We Can Supply Any Extracting Forcep In Black, Titanium, Gold And Rainbow Colours. Choose Any Extracting Forceps And Colour of Your Choice.

EXTRACTING FORCEPS (English Pattern)

Щипцы экстракционные (английская форма)
 Daviers (Forme Anglaise)
 Zahnzangen (Englische Form)

Щипці екстракційні (англійська форма)
 Forceps de Extracción (Forme Inglesa)
 استخراج المنقط (تمط اللغة الإنجليزية)



SSI-A-001
1
upper laterals
and canines



SSI-A-002
2
upper laterals
and canines



SSI-A-003
3
upper laterals
and canines



SSI-A-004
4
lower laterals
and canines



SSI-A-005
7
upper premolars

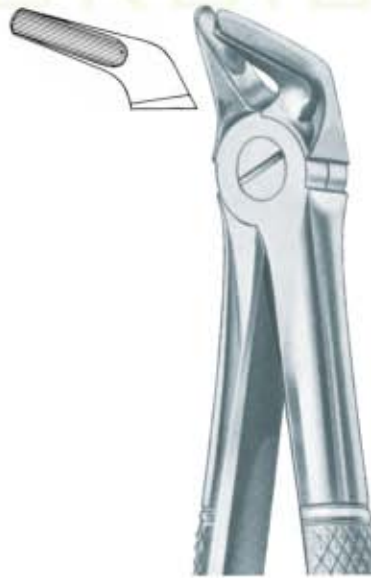

SSI-A-006
8
lower premolars



SSI-A-007
13
lower premolars

EXTRACTING FORCEPS (English Pattern)

- Щипцы экстракционные (английская форма)
- Daviers (Forme Anglaise)
- Zahnzangen (Englische Form)

- Щипці екстракційні (англійська форма)
- Forceps de Extracci3n (Forme Inglesa)
- استخراج الملقط (نمط اللغة الإنجليزية)



SSI-A-008
13S
lower premolars,
for children

SSI-A-009
17
upper molars,
right



SSI-A-010
18
upper molars,
left



SSI-A-011
18A
upper molars



SSI-A-012
18B
upper molars



SSI-A-013
19
upper third molars

Щипцы экстракционные (английская форма)
Daviers (Forme Anglaise)
Zahnzangen (Englische Form)

Щипці екстракційні (англійська форма)
Forceps de Extracció (Forme Inglesa)
استخراج الملقط (نمط اللغة الإنجليزية)



SSI-A-014
20
lower third molar



SSI-A-015
21
lower molar



SSI-A-016
22
lower molar



SSI-A-017
22S
lower molar,
for children



SSI-A-018
22G
lower molar



SSI-A-019
23
lower molar, right



SSI-A-020
24
lower molar, right



EXTRACTING FORCEPS (English Pattern)

■ Щипцы экстракционные (английская форма)
■ Daviers (Forme Anglaise)
■ Zahnzangen (Englische Form)

■ Щипці екстракційні (англійська форма)
■ Forceps de Extracci3n (Forme Inglesa)
■ استخراج الملقط (نمط الفة الإنجليزية)

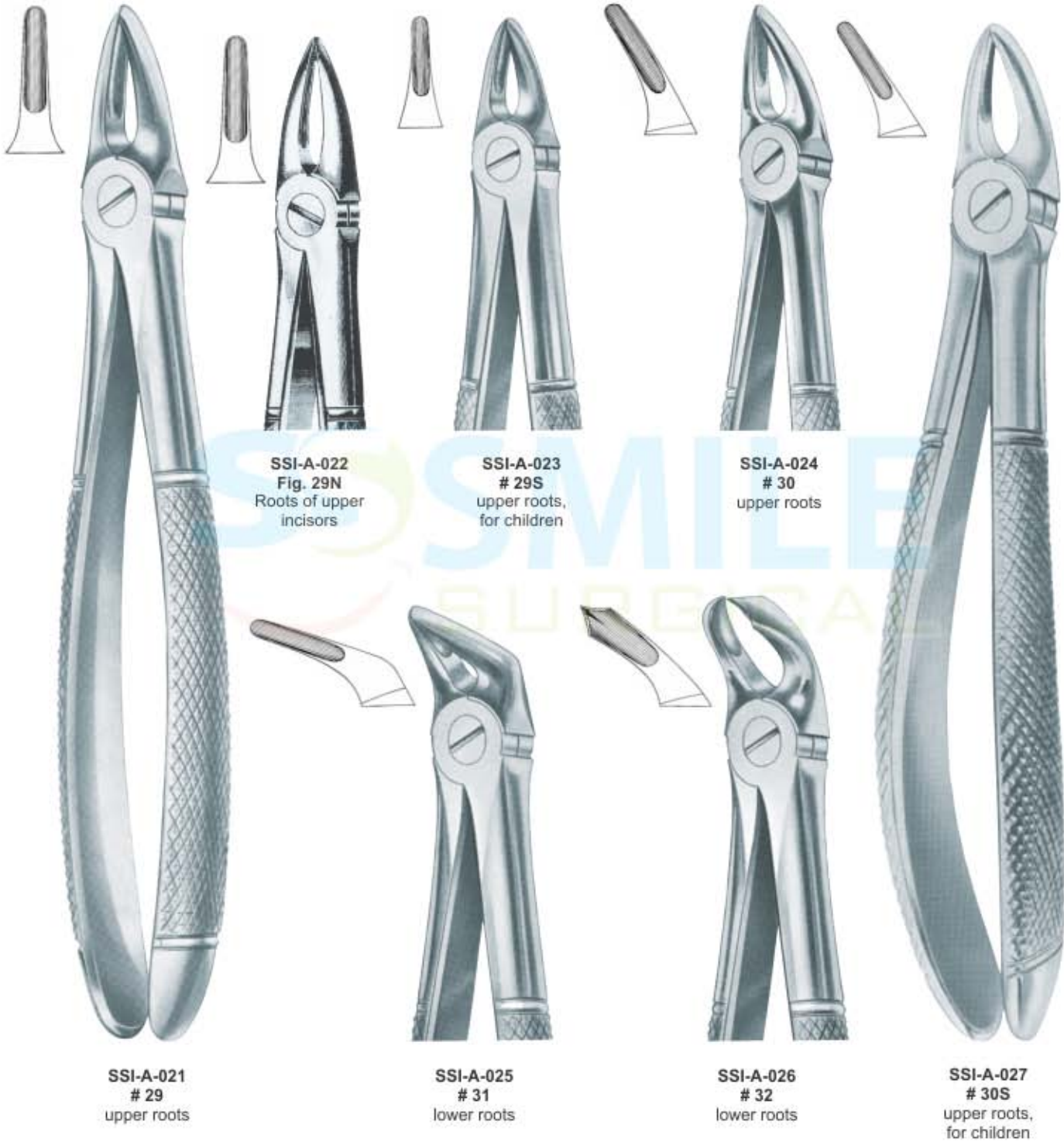

SSI-A-022
 Fig. 29N
 Roots of upper
 incisors

SSI-A-023
 # 29S
 upper roots,
 for children

SSI-A-024
 # 30
 upper roots

SSI-A-021
 # 29
 upper roots

SSI-A-025
 # 31
 lower roots

SSI-A-026
 # 32
 lower roots

SSI-A-027
 # 30S
 upper roots,
 for children

PREMIUM QUALITY DENTAL INSTRUMENTS

Щипцы экстракционные (английская форма)
 Daviers (Forme Anglaise)
 Zahnzangen (Englische Form)

Щипці екстракційні (англійська форма)
 Forceps de Extracción (Forme Inglesa)
 استخراج المنقط (تمط اللغة الإنجليزية)



SSI-A-028
33
lower roots



SSI-A-029
33A
lower roots



SSI-A-030
33B
lower roots



SSI-A-031
33L
lower roots



SSI-A-032
33S
lower roots,
for children



SSI-A-034
Fig. 34
Upper incisors
and premolars
deep-gripping



SSI-A-035
Fig. 35
Upper incisors
and premolars
deep-gripping



SSI-A-036
Fig. 35N
Upper incisors
and premolars
deep-gripping



SSI-A-033
Fig. 33C
Lower roots



SSI-A-037
Fig. 33M
Lower roots
with long beak



SSI-A-038
Fig. 36
Lower premolars
deep-gripping



SSI-A-039
Fig. 36N
Lower premolars
deep-gripping



SSI-A-040
37
upper incisors,
for children

EXTRACTING FORCEPS (English Pattern)

Щипцы экстракционные (английская форма)
 Daviers (Forme Anglaise)
 Zahnzangen (Englische Form)

Щипці екстракційні (англійська форма)
 Forceps de Extracción (Forme Inglesa)
 استخراج الملقط (نمط الفة الإنجليزية)



SSI-A-041
38
 lower incisors and
 canines, for children



SSI-A-042
39
 upper molars
 for children



SSI-A-043
39 R
 upper molars right
 for children



SSI-A-046
39 L
 upper molars left
 for children



SSI-A-044
39 A
 upper molars
 for children



SSI-A-045
40
 lower molars
 for children

Щипцы экстракционные (английская форма)
Daviers (Forme Anglaise)
Zahnzangen (Englische Form)

Щипці екстракційні (англійська форма)
Forceps de Extracción (Forme Inglesa)
استخراج المنقط (تمط اللغة الإنجليزية)



SSI-A-047
Fig. 41
upper roots



SSI-A-048
Fig. 44
upper roots



SSI-A-049
Fig. 45
lower roots



SSI-A-050
Fig. 46
Lower root



SSI-A-051
Fig. 46N
Lower premolars
deep-gripping



SSI-A-055
50
upper roots



SSI-A-052
Fig. 48
lower roots



SSI-A-053
Fig. 49
upper roots



SSI-A-054
Fig. 49L
Very thin lower roots

EXTRACTING FORCEPS (English Pattern)

■ Щипцы экстракционные (английская форма)
■ Daviers (Forme Anglaise)
■ Zahnzangen (Englische Form)

■ Щипці екстракційні (англійська форма)
■ Forceps de Extracció (Forme Inglesa)
■ استخراج الملقط (نمط الفة الإنجليزية)



SSI-A-056
51
upper roots



SSI-A-057
51 A
upper roots



SSI-A-058
51 L
upper roots



SSI-A-059
Fig. 51 C
Upper roots



SSI-A-060
51 S
upper roots,
for children



SSI-A-061
52
upper roots



SSI-A-062
52 A
upper teeth
and resection

Щипцы экстракционные (английская форма)
 Daviers (Forme Anglaise)
 Zahnzangen (Englische Form)

Щипці екстракційні (англійська форма)
 Forceps de Extracción (Forme Inglesa)
 استخراج المتقط (تمط اللغة الإنجليزية)

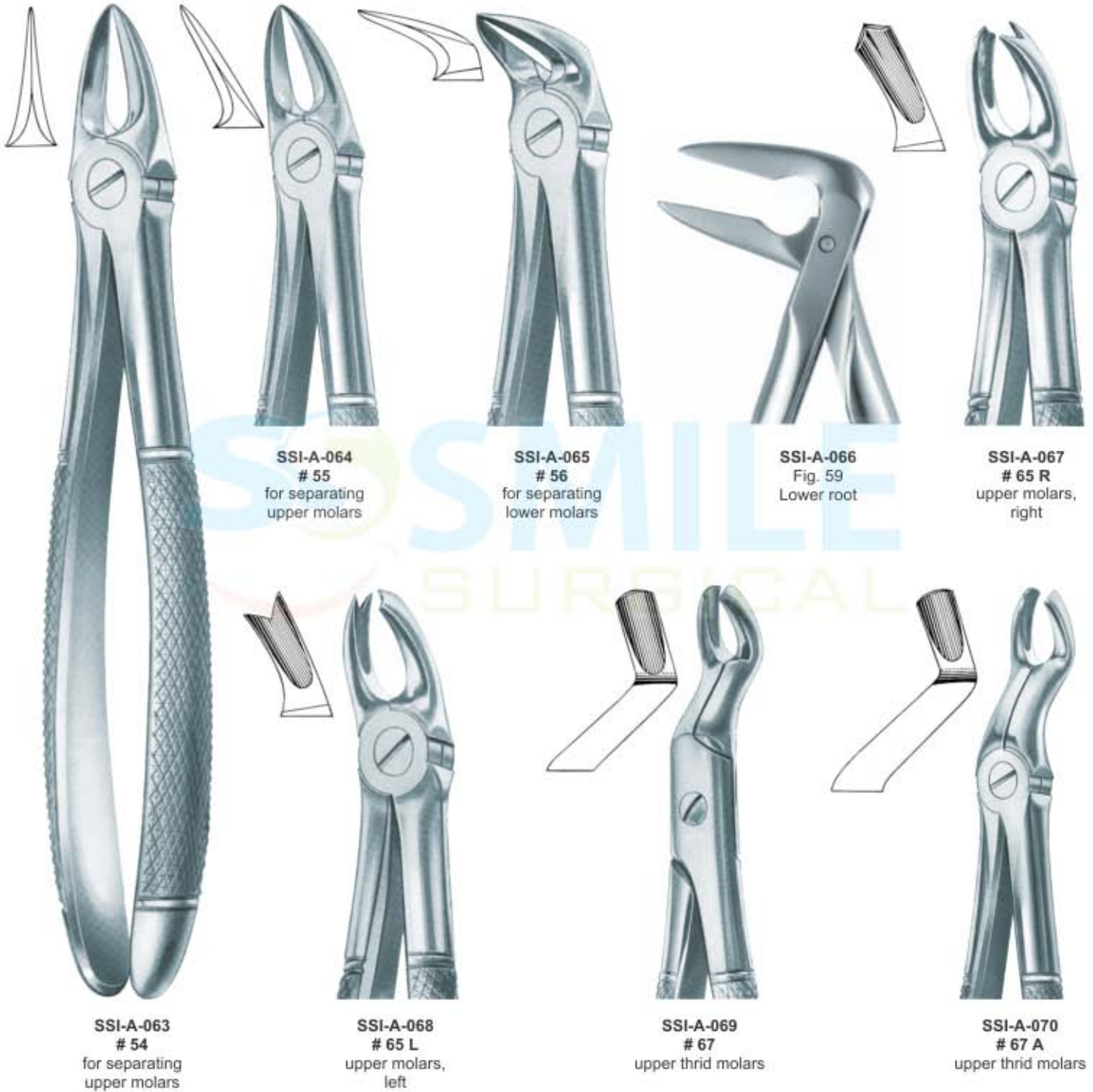

SSI-A-064
55
 for separating
 upper molars

SSI-A-065
56
 for separating
 lower molars

SSI-A-066
 Fig. 59
 Lower root

SSI-A-067
65 R
 upper molars,
 right

SSI-A-063
54
 for separating
 upper molars

SSI-A-068
65 L
 upper molars,
 left

SSI-A-069
67
 upper third molars

SSI-A-070
67 A
 upper third molars

PREMIUM QUALITY DENTAL INSTRUMENTS

EXTRACTING FORCEPS (English Pattern)

- Щипцы экстракционные (английская форма)
- Daviers (Forme Anglaise)
- Zahnzangen (Englische Form)

- Щипці екстракційні (англійська форма)
- Forceps de Extracción (Forme Inglesa)
- استخراج الملقط (نمط اللغة الإنجليزية)

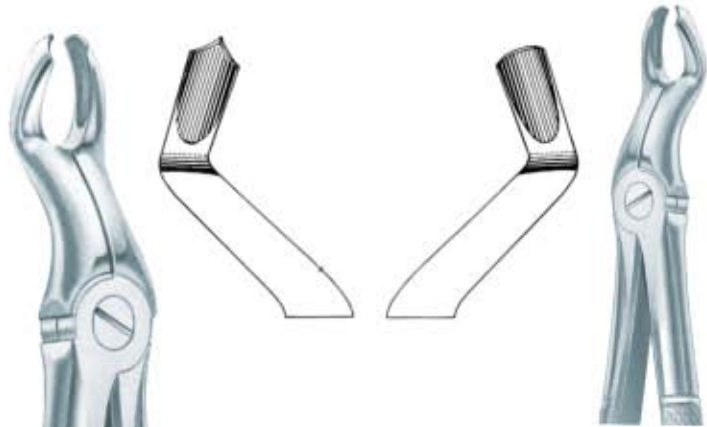

SSI-A-072
67½ L
upper third molars,
left



SSI-A-073
Fig. 67N
Upper third molars



SSI-A-071
67½ R
upper third molars,
right



SSI-A-074
68
lower roots



SSI-A-075
68 A
lower roots



SSI-A-076
73
lower molars



SSI-A-077
73 R
lower molars,
right



SSI-A-078
73 L
lower molars,
left

Щипцы экстракционные (английская форма)
Daviers (Forme Anglaise)
Zahnzangen (Englische Form)

Щипці екстракційні (англійська форма)
Forceps de Extracció (Forme Inglesa)
استخراج الملقط (نمط اللغة الإنجليزية)



SSI-A-079
73 A
lower molars



SSI-A-080
73 S
lower molars



SSI-A-081
73 B
lower molars
for children



SSI-A-084
73 K
lower molars
for children



SSI-A-082
74
lower roots



SSI-A-083
74 D
lower roots

Щипцы экстракционные (английская форма)
 Daviers (Forme Anglaise)
 Zahnzangen (Englische Form)

Щипці екстракційні (англійська форма)
 Forceps de Extracción (Forme Inglesa)
 استخراج الملقط (نمط اللغة الإنجليزية)



SSI-A-085
74M
lower roots



SSI-A-086
74N
lower roots



SSI-A-087
74XN
lower roots and
crowded incisors



SSI-A-088
75
lower premolars



SSI-A-089
76
upper roots



SSI-A-090
76N
upper roots

Щипцы экстракционные (английская форма)
 Daviers (Forme Anglaise)
 Zahnzangen (Englische Form)

Щипці екстракційні (англійська форма)
 Forceps de Extracción (Forme Inglesa)
 استخراج المتقط (تمقط اللغة الإنجليزية)



SSI-A-091
76S
upper roots



SSI-A-092
79
lower third molars



SSI-A-093
79A
lower third molars



With Serrated
Tips

SSI-A-095
Fig. 79C
Lower third molars



SSI-A-094
Fig. 79N
Lower third molars



SSI-A-096
81
lower premolars
and roots



SSI-A-097
80
upper molar roots

EXTRACTING FORCEPS (English Pattern)

Щипцы экстракционные (английская форма)
 Daviers (Forme Anglaise)
 Zahnzangen (Englische Form)

Щипці екстракційні (англійська форма)
 Forceps de Extracción (Forme Inglesa)
 استخراج الملقط (نمط اللغة الإنجليزية)



SSI-A-098
 # 86A
 lower molars



SSI-A-099
 # 86B
 lower molars



SSI-A-100
 # 86C
 lower molars



SSI-A-101
 # 87
 lower molars

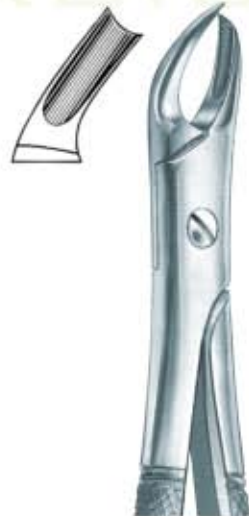

SSI-A-102
 # 89
 upper molars,
 right



SSI-A-103
 # 90
 upper molars,
 left

Щипцы экстракционные (английская форма)
 Daviers (Forme Anglaise)
 Zahnzangen (Englische Form)

Щипці екстракційні (англійська форма)
 Forceps de Extracción (Forme Inglesa)
 استخراج المنقط (تمط اللغة الإنجليزية)



SSI-A-104
92
upper second molars,
right

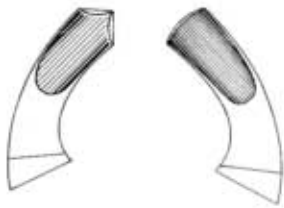

SSI-A-105
93
upper second molars,
left



SSI-A-106
94
upper molars,
right

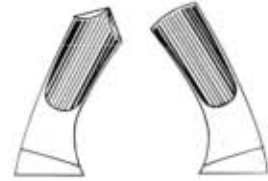

SSI-A-107
91
for separating
lower molars



SSI-A-108
99
lower molars



SSI-A-109
Fig. 97
Very thin
upper roots



SSI-A-110
95
upper molars,
left

Щипцы экстракционные (английская форма)
 Daviers (Forme Anglaise)
 Zahnzangen (Englische Form)

Щипці екстракційні (англійська форма)
 Forceps de Extracción (Forme Inglesa)
 استخراج الملقط (نمط اللغة الإنجليزية)



SSI-A-111
99 1/4
lower molars

SSI-A-112
99 1/2
lower molars



SSI-A-115
100
upper roots

SSI-A-116
101
upper premolars
and roots



SSI-A-113
Fig. 233
Lower root
(parallel beaks)

SSI-A-114
Fig. 235
Upper root
(parallel beaks)

Щипцы экстракционные (английская форма)
 Daviers (Forme Anglaise)
 Zahnzangen (Englische Form)

Щипці екстракційні (англійська форма)
 Forceps de Extracción (Forme Inglesa)
 استخراج المتقط (تمط اللغة الإنجليزية)



SSI-A-117
104
upper roots



SSI-A-118
102
upper molars,
right



SSI-A-119
103
upper molars,
left



SSI-A-120
105
lower incisors



SSI-A-121
106
lower incisors



SSI-A-122
107
upper canines

EXTRACTING FORCEPS (English Pattern)

■ Щипцы экстракционные (английская форма)
■ Daviers (Forme Anglaise)
■ Zahnzangen (Englische Form)

■ Щипці екстракційні (англійська форма)
■ Forceps de Extracción (Forme Inglesa)
■ استخراج الملقط (نمط اللغة الإنجليزية)



SSI-A-123
112
 upper roots



SSI-A-124
113
 upper roots



SSI-A-126
136
 upper premolars
 and roots



SSI-A-127
137
 lower incisors
 and roots



SSI-A-125
114
 lower roots



SSI-A-128
143
 lower roots

Щипцы экстракционные (английская форма)
 Daviers (Forme Anglaise)
 Zahnzangen (Englische Form)

Щипці екстракційні (англійська форма)
 Forceps de Extracción (Forme Inglesa)
 استخراج المتقط (تمط اللغة الإنجليزية)

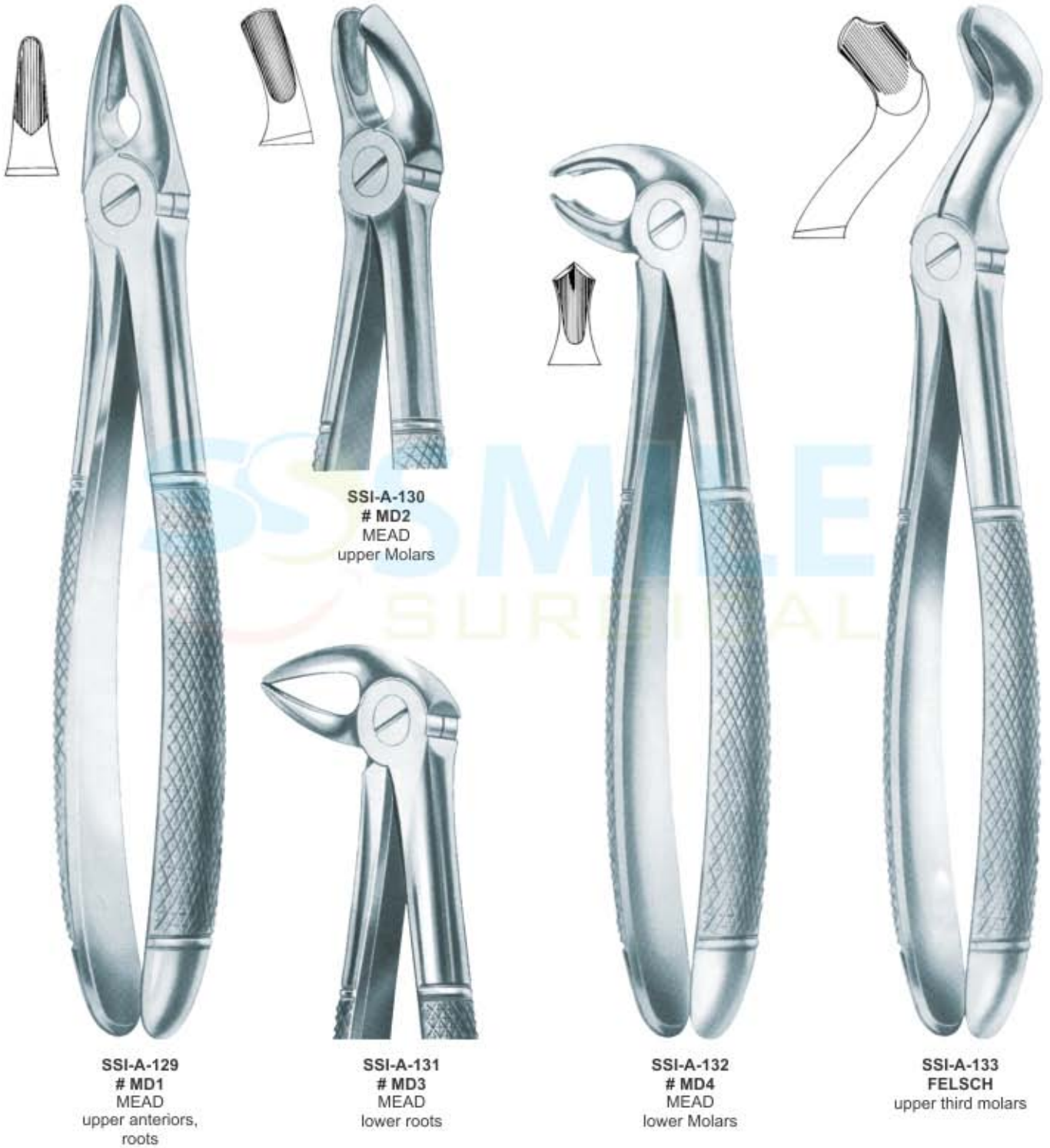

EXTRACTING FORCEPS (English Pattern)

- Щипцы экстракционные (английская форма)
- Daviers (Forme Anglaise)
- Zahnzangen (Englische Form)

- Щипці екстракційні (англійська форма)
- Forceps de Extracció (Forme Inglesa)
- استخراج الملقط (نمط اللغة الإنجليزية)



**SSI-A-134
STIKSA**
lower molars
and wisdoms



**SSI-A-135
STIKSA**
lower molars and
wisdoms roots

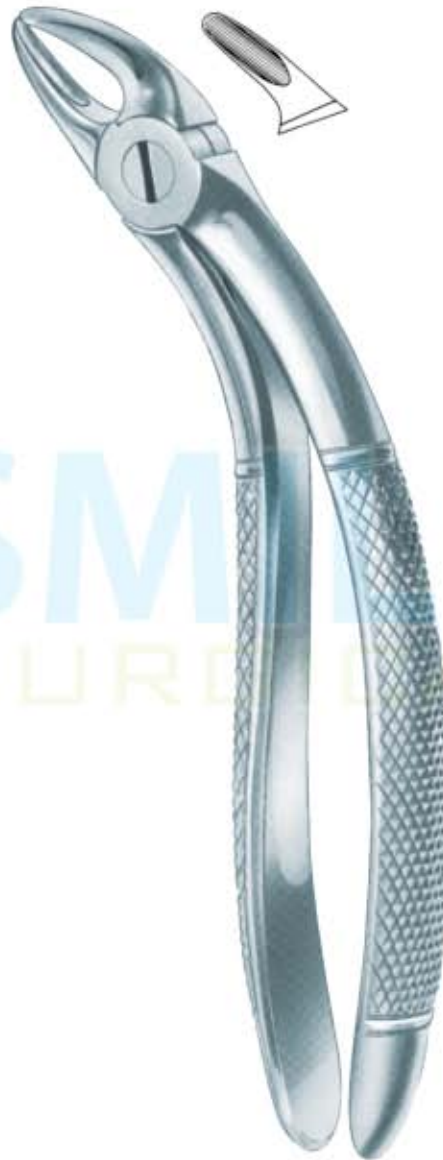

**SSI-A-136
HERTZ**
lower molars
and wisdoms roots



**SSI-A-137
HERTZ**
lower incisors

Щипцы экстракционные (английская форма)
Daviers (Forme Anglaise)
Zahnzangen (Englische Form)

Щипці екстракційні (англійська форма)
Forceps de Extracción (Forme Inglesa)
استخراج المنقط (نمط اللغة الإنجليزية)



SSI-A-138
Fig. 158
Children's Upper Teeth Molars Universal



SSI-A-139
Fig. 159
Children's upper Molars Universal



SSI-A-140
Fig. 160
Children's Upper Lower Universal (Hawk's Bill)

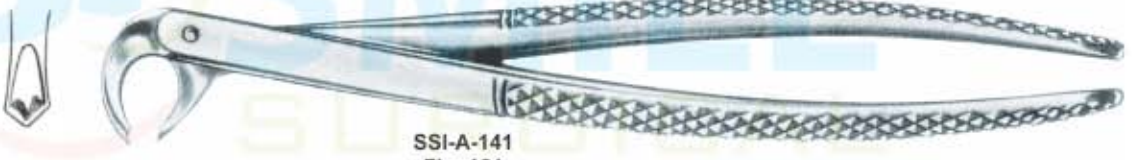

SSI-A-141
Fig. 161
Children's Lower Centrals & Roots

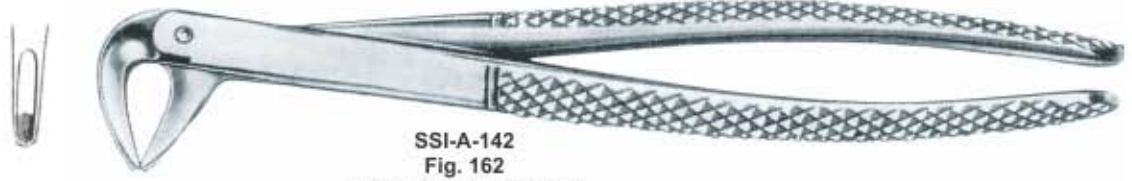

SSI-A-142
Fig. 162
Children's Upper Centrals



SSI-A-143
Fig. 163
Children's Upper Centrals



SSI-A-144
Fig. 37
Children's Upper Incisors & Canines

EXTRACTING FORCEPS (English Pattern)

■ Щипцы экстракционные (английская форма)
■ Daviers (Forme Anglaise)
■ Zahnzangen (Englische Form)

■ Щипці екстракційні (англійська форма)
■ Forceps de Extracción (Forme Inglesa)
■ استخراج الملقط (نمط الفة الإنجليزية)



SSI-A-145
Fig. 123
 Children's Lower Teeth Universal



SSI-A-146
Fig. 138
 Children's Upper Universal & Roots

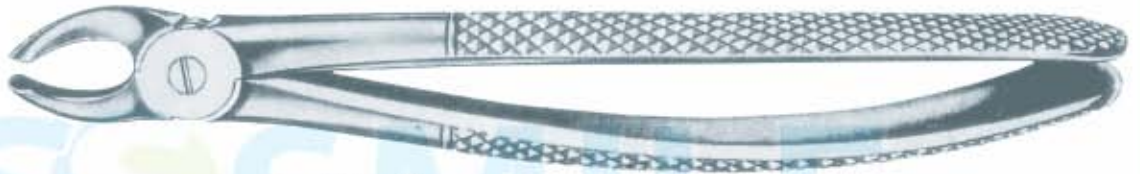

SSI-A-147
Fig. 157
 Children's Upper Morals Universal

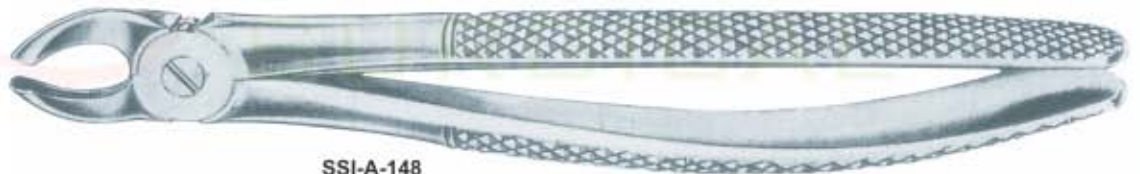

SSI-A-148
Fig. 39
 Children's Upper Morals Universal

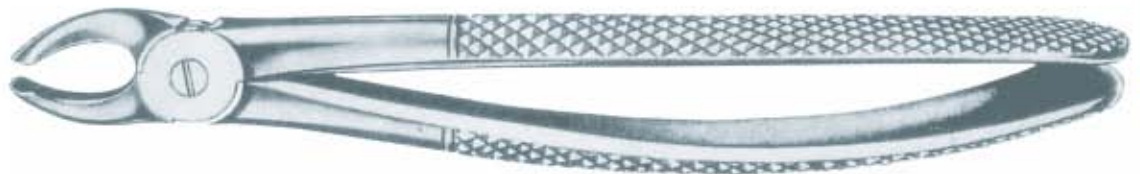

SSI-A-149
Fig. 39R
 Children's Upper Morals Right

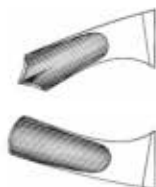

SSI-A-150
Fig. 39L
 Children's Upper Morals Left

Щипцы экстракционные для зубов мудрости (английская форма)
 Daviers (Forme Anglaise)
 Zahnzangen (Englische Form)

Щипці екстракційні для зубів мудрості (англійська форма)
 Forceps de Extracción (Forme Inglesa)
 الحکمة استخراج الملقط



SSI-A-151
Routerier
Fig. 22 ½ L
Lower Molars and
Wisdoms, Left



SSI-A-152
Routerier
Fig. 22 ½ R
Lower Molars and
Wisdoms, Right



SSI-A-153
Routerier
Fig. 33 ½ L
Lower Molar and
Wisdom Roots, Left



SSI-A-154
Routerier
Fig. 33 ½ R
Lower Molar and
Wisdom Roots, Right



SSI-A-155
Fig. 186L
Lower Molars



SSI-A-156
Fig. 186R
Lower Molars

Щипцы экстракционные (английская форма)
 Daviers (Forme Anglaise)
 Zahnzangen (Englische Form)

Щипці екстракційні (англійська форма)
 Forceps de Extracción (Forme Inglesa)
 استخراج الملقط (نمط الفة الإنجليزية)



SSI-A-157
Busch
lower roots



SSI-A-158
Busch
lower roots



SSI-A-159
Witzel
lower roots



SSI-A-160
Fig. 146
Upper and lower roots
deep-gripping



SSI-A-161
Fig. 333S
Very thin lower
roots



SSI-A-162
Fig. 151
upper roots



SSI-A-163
Fig. 351S
Very thin
upper roots

Щипцы экстракционные (английская форма)
 Daviers (Forme Anglaise)
 Zahnzangen (Englische Form)

Щипці екстракційні (англійська форма)
 Forceps de Extracción (Forme Inglesa)
 استخراج المتقط (تمط اللغة الإنجليزية)



SSI-A-164
Fig. 121
Upper Third
Molars

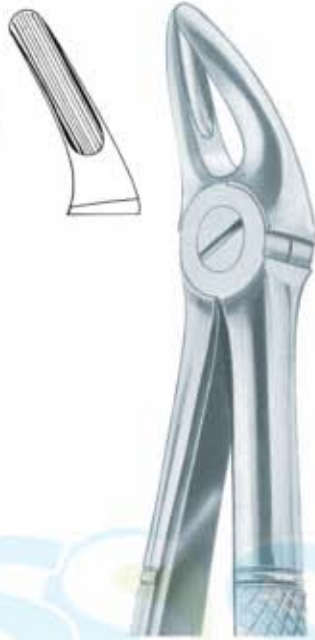

SSI-A-165
Fig. 136
Upper Premolars
and Roots



SSI-A-166
Fig. 137
Lower Incisors
and Roots

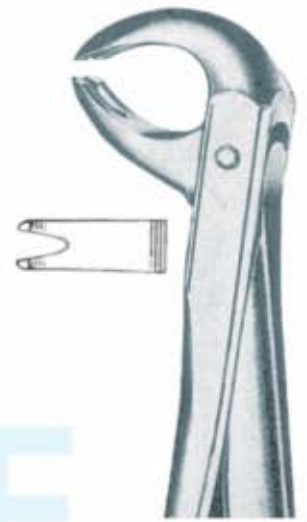

SSI-A-167
Fig. 167
Universal Patter
For Lower Teeth
Molars & Premolars



SSI-A-168
Fig. 168
Upper Canines



SSI-A-169
Fig. 169
Lower Canines &
Permolars



SSI-A-170
Fig. 233
Lower Root
(Parallel Beaks)

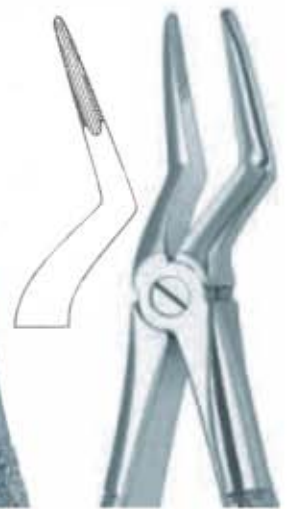

SSI-A-171
Fig. 235
Upper Root
(Parallel Beaks)

- Щипцы экстракционные детские
- Щипці екстракційні дитячі
- Daviers - forme anglaise
- Férceps de extracción - forma inglesa
- Pinzeper per estrazione per bambini
- مستخرج المناطق (للأطفال)

Pediatric Tooth Extracting Forceps



SSI-A-172
English Pattern
Klein Fig. 4
Pedodontic Upper root



SSI-A-175
English Pattern
Klein Fig. 1
Pedodontic, Upper Incisors



SSI-A-176
English Pattern Klein Fig. 5
Pedodontic Lower Incisors.



SSI-A-173
English Pattern
Klein Fig. 2
Pedodontic Upper Premolars



SSI-A-177
English Pattern
Klein Fig. 6
Pedodontic Lower Molars

Baby Tooth Extraction Forceps



SSI-A-174
English Pattern
Klein Fig. 3
Pedodontic Upper Molars Universal



SSI-A-179
Set of 7 Pieces



SSI-A-178
English Pattern
Klein Fig. 7
Pedodontic Lower Molars,

EXTRACTING FORCEPS (For Children)

Щипцы экстракционные детские
Daviers - forme anglaise
Pinzeper per estrazione per bambini

Щипці екстракційні дитячі
Fórceps de extracci3n - forma inglesa
ستخراج الملقط (للأطفال)



SSI-A-180
Fig. 1
upper incisors



SSI-A-181
Fig. 2
upper premolars



SSI-A-182
Fig. 3
upper molars



SSI-A-183
Fig. 4
upper roots

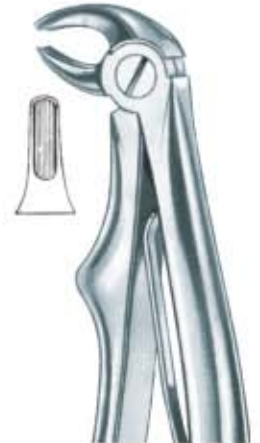

SSI-A-184
Fig. 5
lower incisors



SSI-A-185
Fig. 6
lower molars



SSI-A-186
Fig. 7
lower roots



For Special Packing of Baby Extracting Forceps Please Ask

SSI-A-187
Baby Extracting Forceps
Set of 07 Pcs
(Rainbow Coating)
Fig 1
Fig 2
Fig 3
Fig 4
Fig 5
Fig 6
Fig 7

SSI-A-188
Baby Extracting Forceps
Set of 07 Pcs
Fig 1
Fig 2
Fig 3
Fig 4
Fig 5
Fig 6
Fig 7

EXTRACTING FORCEPS (English Pattern)

Щипцы экстракционные (английская форма)
 Daviers (Forme Anglaise)
 Zahnzangen (Englische Form)

Щипці екстракційні (англійська форма)
 Forceps de Extracción (Forme Inglesa)
 استخراج الملقط (نمط الفة الإنجليزية)



SSI-A-189
Fig. 151 SK
 Lower Incisors,
 Premolars, Roots

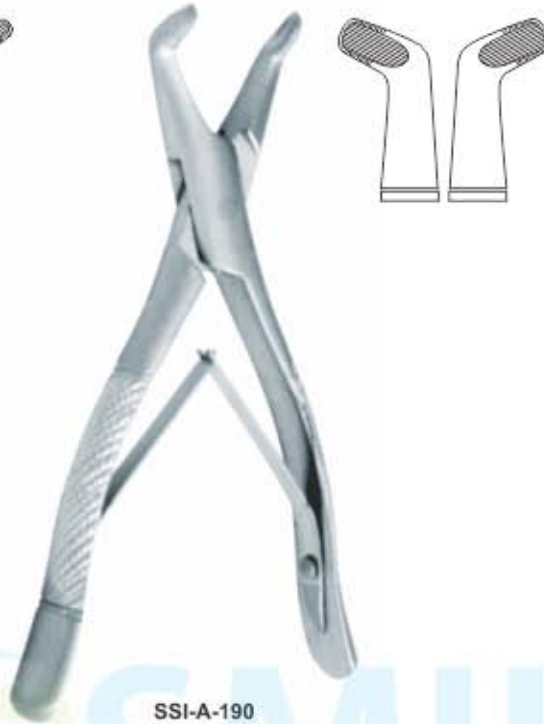

SSI-A-190
Fig. 222 SK
 Lower Third Molars



SSI-A-191
Fig. 560
 Upper Incisors

Deep Gripping Root Forceps



SSI-A-192
Fig. 146
 Upper Roots



SSI-A-193
Fig. 149
 Lower Roots



SSI-A-194
Fig. 153
 Upper Roots

ROOTS SPLINTER FORCEPS

Щипцы для удаления корневых осколков
Pinces Fragments
Wurzelsplitterzangen

Щипці для видалення корневих осколків
Pinzas Para Fragmentos
جنور منشقة الملقط



SSI-A-195
Witzel 221
Universal Pattern For
Upper Teeth



SSI-A-196
Witzel 223
Universal Pattern For
Lower Teeth



SSI-A-197
Ralk
Root Fragments



SSI-A-198
Stieglitz
Root Fragments



SSI-A-199
Stieglitz
Root Fragments



SSI-A-200
Stieglitz Splinter Forceps
140mm 90°



SSI-A-201
Stieglitz Splinter Forceps
140mm Straight

EXTRACTING FORCEPS (For Children)



- Шипцы экстракционные детские
- Daviers - forme anglaise
- Pinzeper per estrazione per bambini
- Шипці екстракційні дитячі
- Férceps de extracción - forma inglesa
- مستخرج المناطق (للأطفال)



SSI-A-202
Koehler
Luxation Forceps
Right & Left Molars

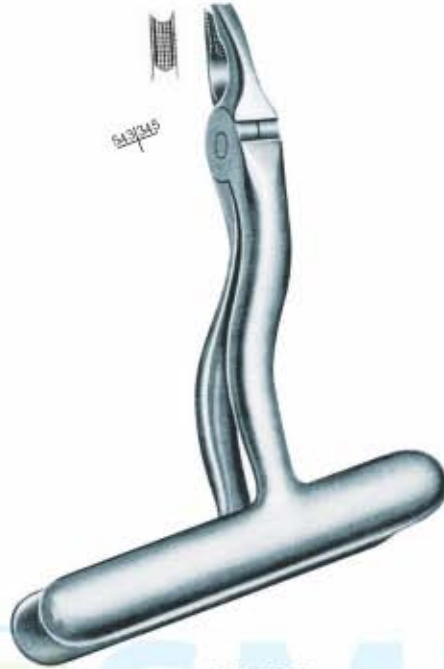

SSI-A-203
Upper Canines
& Premolars

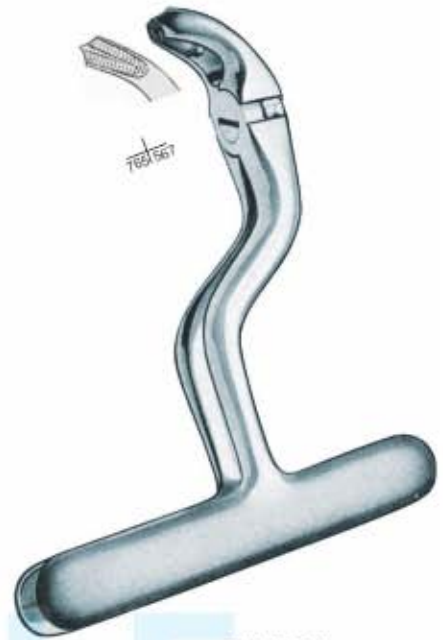

SSI-A-204
Lower Molars
Either Side



SSI-A-205
Lower Third Molars



SSI-A-206
Albrecht
160mm



SSI-A-207
Albrecht
160mm

deciduous teeth

Щипцы экстракционные детские
Daviers - forme anglaise
Pinzere per estrazione per bambini

Щипці екстракційні дитячі
Fórceps de extracci3n - forma inglesa
ستخراج الملقط (للأطفال)



SSI-A-208
Fig.10 SK
Upper Molars Sup, 10SK



SSI-A-209
Fig.17 SK
Universal
Lower Molars



SSI-A-210
Fig.23 SK
Universal
Upper Molars



SSI-A-211
Fig. 69 SK
Tomas
Upper and Lower Molars



SSI-A-212
Fig. 99 SK
Upper Incisors,
Canines, Premolars



SSI-A-213
Fig. 150 SK
Upper Incisors,
Premolars, Roots



SSI-A-214
Fig. 151 SK
Lower Incisors,
Premolars, Roots



SSI-A-215
Fig. 222 SK
Lower Third Molars

Щипцы экстракционные (английская форма)
 Daviers (Forme Anglaise)
 Zahnzangen (Englische Form)

Щипці екстракційні (англійська форма)
 Forceps de Extracción (Forme Inglesa)
 استخراج الملقط (نمط اللغة الإنجليزية)

Deep Gripping Root Forceps

SSI-A-216
Upper Centrals
Fig. 34A

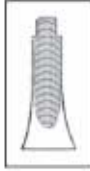

SSI-A-217
Upper Premolar
Fig. 35A



SSI-A-218
Upper Roots
Fig. 331



SSI-A-219
Lower Premolar
Fig. 336



SSI-A-220
Lower Premolar
Fig. 36A



Щипцы экстракционные (английская форма)
 Daviers (Forme Anglaise)
 Zahnzangen (Englische Form)

Щипці екстракційні (англійська форма)
 Forceps de Extracción (Forme Inglesa)
 استخراج المتقط (تمط اللغة الإنجليزية)

Deep Gripping Root Forceps



SSI-A-221
Upper Third Molars
Fig. 67N



SSI-A-222
Lower Third Molars
Fig. 79N



SSI-A-223
Upper Premolars
Fig. 7N



SSI-A-224
Lower Premolars
Fig. 36N

EXTRACTING FORCEPS (English Pattern Hole Handle)

Щипцы экстракционные (английская форма)
 Daviers (Forme Anglaise)
 Zahnzangen (Englische Form)

Щипці екстракційні (англійська форма)
 Forceps de Extracción (Forme Inglesa)
 استخراج الملقط (نمط الفة الإنجليزية)

(Deep Gripe Extracting Forceps)



- No Fracture
- No Tissue Damage
- Extraction With Easy

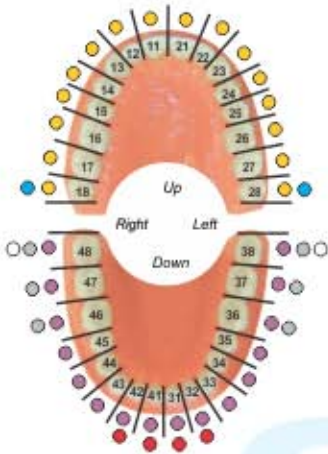

SSI-A-225
 Fig. 34
 Upper Anterior

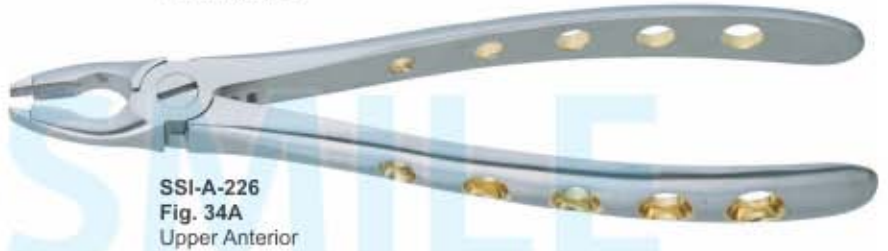

SSI-A-226
 Fig. 34A
 Upper Anterior



SSI-A-227
 Fig. 35
 Upper Universal



SSI-A-228
 Fig. 35A
 Upper Universal



SSI-A-229
 Fig. 321
 Lower Universal

A-TRAUMATIC EXTRACTION FORCEPS
 Improved tapered beaks for complete root contact.
 .Cross serrations for a never slip grasp.
 Easily enter the sub gingival.

Щипцы экстракционные (английская форма)
 Daviers (Forme Anglaise)
 Zahnzangen (Englische Form)

Щипці екстракційні (англійська форма)
 Forceps de Extracción (Forme Inglesa)
 استخراج المنطق (تمط اللغة الإنجليزية)

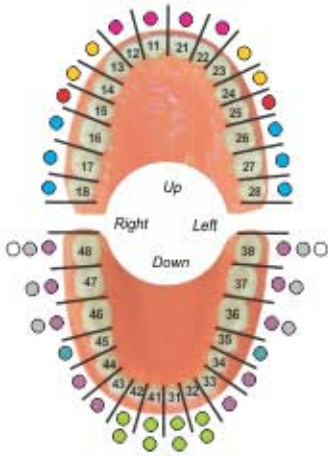

Deep Root Pick Forceps

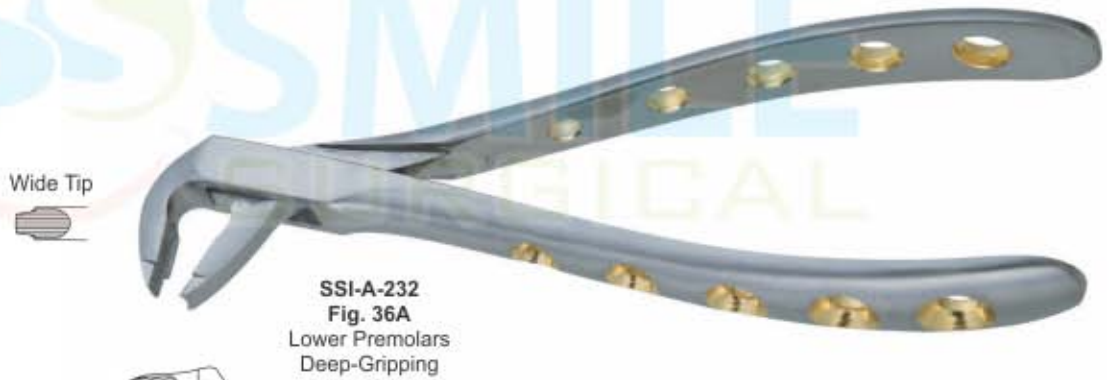

Щипцы экстракционные (английская форма)
Daviers (Forme Anglaise)
Zahnzangen (Englische Form)

Щипці екстракційні (англійська форма)
Forceps de Extracció (Forme Inglesa)
استخراج الملقط (نمط الفة الإنجليزية)

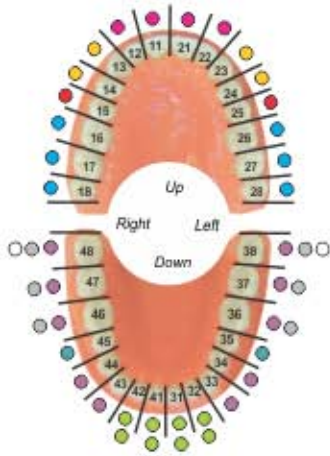

DEEP ROOT PICK FORCEPS

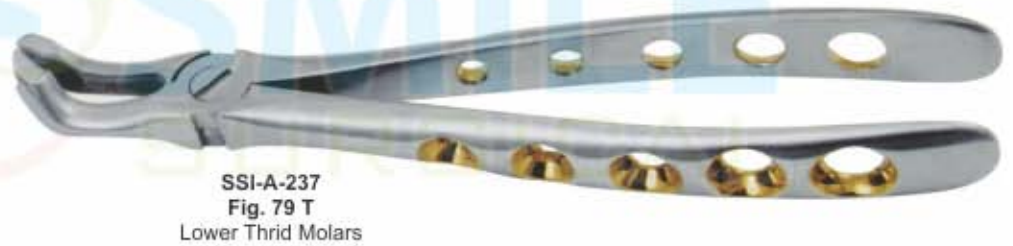

Щипцы экстракционные (английская форма)
 Daviers (Forme Anglaise)
 Zahnzangen (Englische Form)

Щипці екстракційні (англійська форма)
 Forceps de Extracción (Forme Inglesa)
 استخراج المنطق (نمط اللغة الإنجليزية)

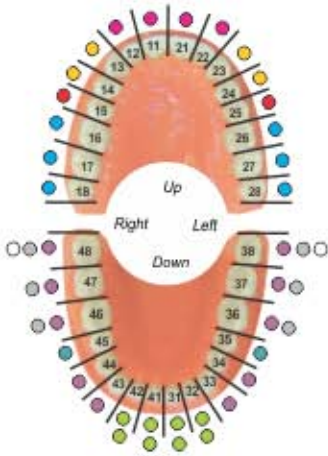

DEEP ROOT PICK FORCEPS



SSI-A-240
Fig. 51
 Apex Forceps
 Upper Root
 Deep Root Pick



SSI-A-241
Fig. 46XL
 Apex Forceps Lower Root
 Deep Root Pick



SSI-A-242
 Upper Root
 Fig. 44



SSI-A-243
 Lower Root
 Fig. 45



SSI-A-244
 Upper Root
 Fig. 51

Щипцы экстракционные (американская форма)
 Daviers - forme americane
 Fórceps de extracción - forma americana

Щипці екстракційні (американська форма)
 Pinzoper per estrazione - forma americana
 استخراج المنقط (النمط الأمريكي)

Carbide Tipped Root Tip Forceps



SSSI-A-245
T.C.
Carbide Serrated Beak
Lower Root Tips & Molars



SSSI-A-246
Root Tip-Lower
Carbide Serrated Beak
Lower Root Tips & Molars



SSSI-A-247
Root Tip-Upper
Carbide Serrated Beak
Lower Root Tips & Molars

German Stainless Steel Extraction Forceps



SSSI-A-248
150AS
Serrated Beak
Upper Anteriors,
Split Beaks



SSSI-A-249
151AS
Serrated Beak
Lower Anteriors,
Split Beaks



SSSI-A-250
23
1st & 2nd Lower Molars
Universal, Cow Horn

Wrap Around Forcep



SSSI-A-251
Wrap around extraction forcep
right angle "Wrap Around" Design
Provides Superior Access
Serrated Beak

Щипцы экстракционные (американская форма)
 Daviers - forme americane
 Fórceps de extracción - forma americana

Щипці екстракційні (американська форма)
 Pinzere per estrazione - forma americana
 استخراج الملقط (النمط الأمريكي)

Carbide Tip Extraction Forceps - Better Grip & Tactile Feel - Less Trauma



SSI-A-253
151 T.C.
Carbide Serrated Beak
Lower Incisors, Cuspids,
Bicuspids & Roots, Universal



SSI-A-254
1STD T.C.
Carbide Serrated Beak
Upper Incisors, Cuspids,



SSI-A-255
17 T.C.
Carbide Serrated Beak
1st & 2nd Lower Molars,
Universal



SSI-A-256
53L T.C.
Carbide Serrated Beak
1st & 2nd Upper Molars,
Left



SSI-A-257
53R T.C.
Carbide Serrated Beak
1st & 2nd Upper Molars,
Right



SSI-A-258
65 T.C.
Carbide Serrated Beak
Upper Incisors, Roots &
Fragments



SSI-A-252
150 T.C.
Carbide Serrated Beak
Upper Incisors, Cuspids,
Bicuspids & Roots,
Universal



SSI-A-259
69 T.C.
Carbide Serrated Beak
Upper & Lower Fragments
And Roots



SSI-A-260
150S T.C. Pedro forcep
Carbide Serrated Beak
Pedo, Upper Primary Teeth
and Roots, Universal



SSI-A-261
151S T.C. Pedro forcep
Carbide Serrated Beak
Pedo, Lower Primary Teeth
and Roots, Universal

EXTRACTING FORCEPS (American Pattern)

Щипцы экстракционные (американская форма)
 Daviers - forme americane
 Fórceps de extracción - forma americana

Щипці екстракційні (американська форма)
 Pinzoper per estrazione - forma americana
 استخراج المنقذ (النمط الأمريكي)



SSI-A-262
 45° Angled Root Forcep
 "Fish-Hook" Serrations
 Upper Atraumatic Extraction



SSI-A-263
 90° Angled Root Forcep
 "Fish-Hook" Serrations
 Upper Atraumatic Extraction



SSI-A-264
 Fig. 01
 witzel
 Radici inferiori
 Lower roots



SSI-A-265
 Fig. 02
 witzel
 Radici superiori
 Upper roots



SSI-A-266
 Fig. 01
 Straight for pins
 and fragments



SSI-A-267
 Fig. 00 - Lindo Levien
 Straight for roots and
 fragments - TC coating



SSI-A-268
 Fig. 01 - Lindo Levien
 Curved for roots and
 fragments - TC coating



SSI-A-269
 Fig. 02
 Curved for pins
 and fragments

Щипцы экстракционные (американская форма)
 Daviers - forme americane
 Fórceps de extracción - forma americana

Щипці екстракційні (американська форма)
 Pinzere per estrazione - forma americana
 استخراج الملقط (النمط الأمريكي)



SSI-A-270
W1
 Winter
 upper centrals
 and canines

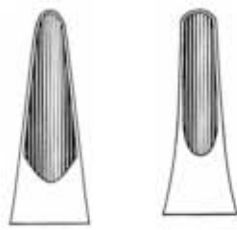

SSI-A-271
1
 upper incisors
 and roots



SSI-A-272
2
 upper and
 lower roots

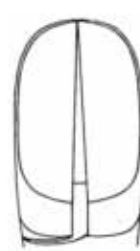

SSI-A-273
4
 upper and
 lower premolars

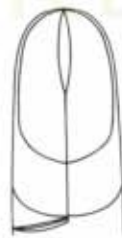

SSI-A-274
5
 Physick
 lower third molars

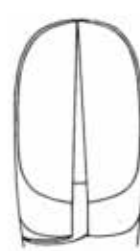

SSI-A-275
6
 separating forceps
 spaltzange

EXTRACTING FORCEPS (American Pattern)

■ Щипцы экстракционные (американская форма)
■ Daviers - forme américaine
■ Fórceps de extracción - forma americana

■ Щипці екстракційні (американська форма)
■ Pinzoper per estrazione - forma americana
■ استخراج الملقط (التمط الأمريكي)



SSI-A-276
7
 upper roots

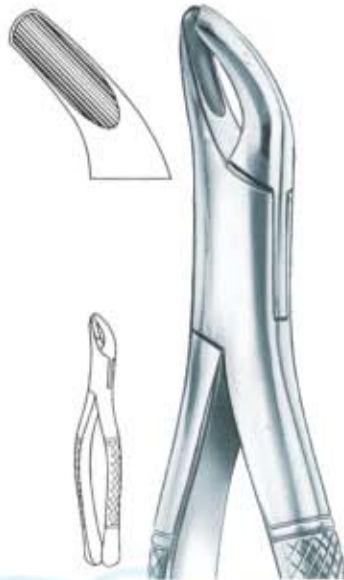

SSI-A-277
8
 upper and lower
 third molars

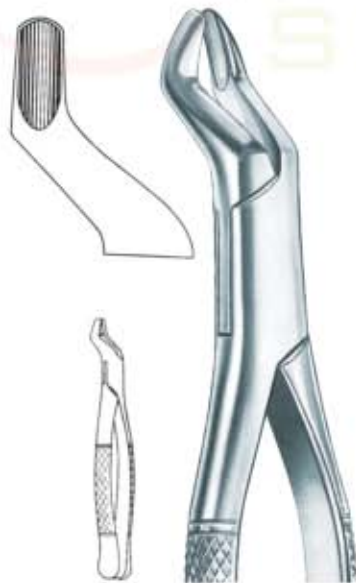

SSI-A-278
10S
 upper roots



SSI-A-279
10 H
 upper molars

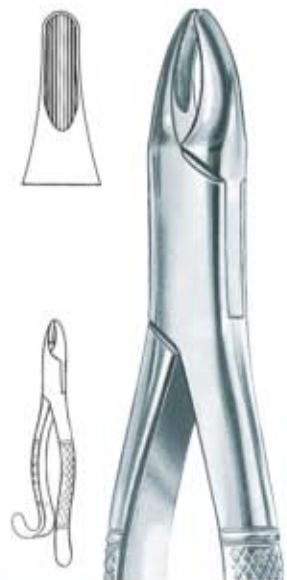

SSI-A-280
13
 upper incisors

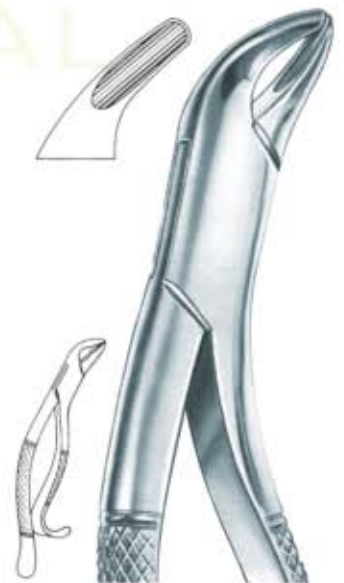

SSI-A-281
14
 lower incisors

Щипцы экстракционные (американская форма)
 Daviers - forme américaine
 Fórceps de extracción - forma americana

Щипці екстракційні (американська форма)
 Pinzere per estrazione - forma americana
 استخراج الملقط (النمط الأمريكي)



SSI-A-282
15
Harris
lower molars

SSI-A-285
17
lower molars



SSI-A-283
16S
lower molars
for children



SSI-A-284
16
lower molars



SSI-A-286
18 L
Harris
upper molars,
left



SSI-A-287
18R
Harris
upper molars,
right

EXTRACTING FORCEPS (American Pattern)

Щипцы экстракционные (американская форма)
 Daviers - forme américaine
 Fórceps de extracción - forma americana

Щипці екстракційні (американська форма)
 Pinzoper per estrazione - forma americana
 استخراج الملقط (النمط الأمريكي)

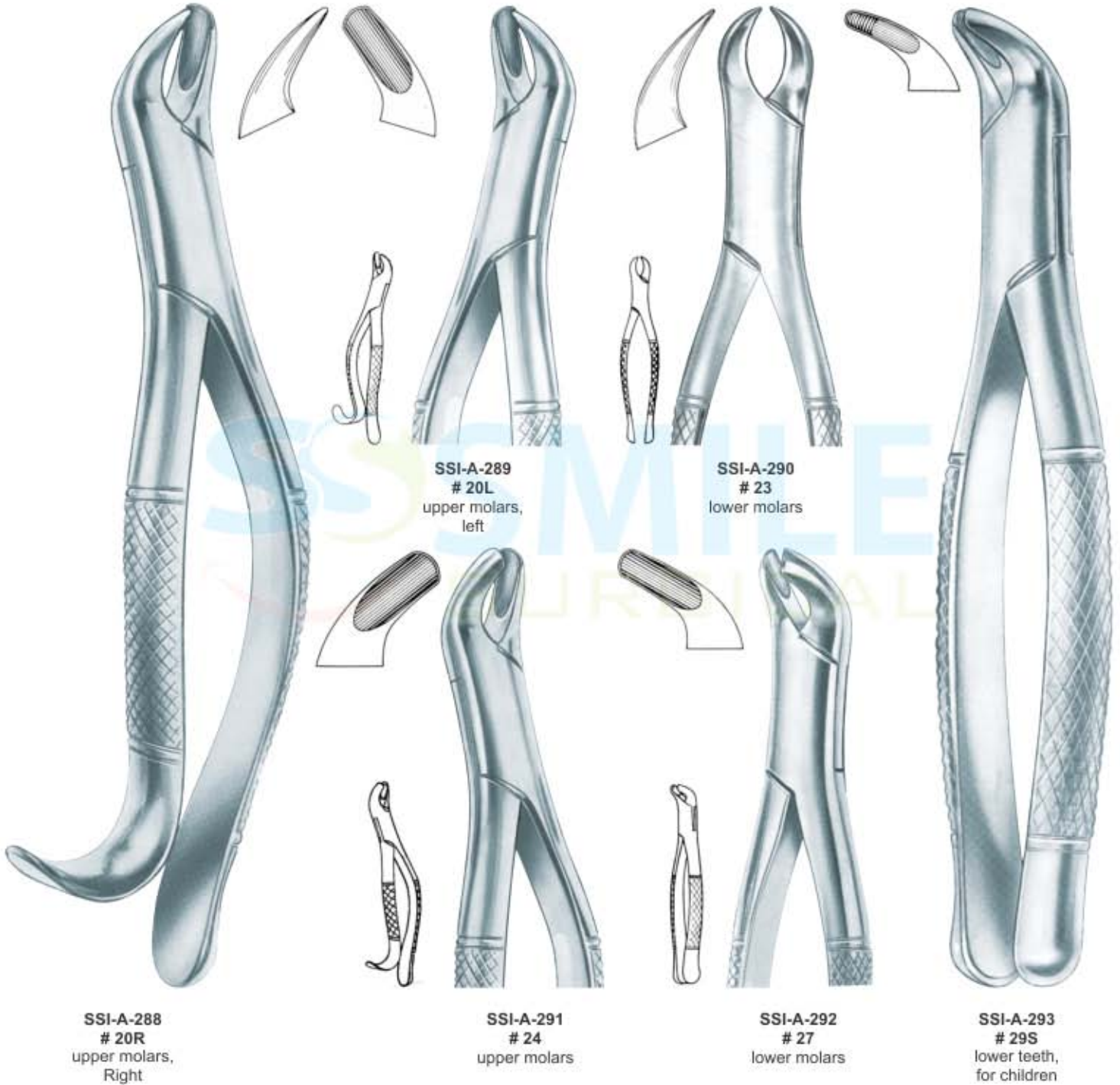

EXTRACTING FORCEPS (American Pattern)

Щипцы экстракционные (американская форма)
Daviers - forme americane
Fórceps de extracción - forma americana

Щипці екстракційні (американська форма)
Pinzere per estrazione - forma americana
ستخراج الملقط (النمط الأمريكي)



SSI-A-294
30S
upper teeth,
for children



SSI-A-295
32 Parmlly
upper premolars
and molars



SSI-A-296
32A Parmlly
upper premolars
and roots

SSI-A-298
35
upper roots



SSI-A-297
30S
lower anteriors,
and roots



SSI-A-299
36
lower anteriors,
and roots

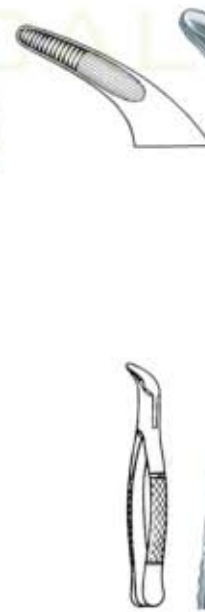

EXTRACTING FORCEPS (American Pattern)

Щипцы экстракционные (американская форма)
 Daviers - forme américaine
 Fórceps de extracción - forma americana

Щипці екстракційні (американська форма)
 Pinzere per estrazione - forma americana
 استخراج الملقط (التمط الأمريكي)



SSI-A-300
37
 lower anteriors
 and roots



SSI-A-302
53 R
 upper molars,
 right



SSI-A-303
53 L
 upper molars,
 left



SSI-A-301
38
 upper anteriors
 and roots



SSI-A-304
62
 incisors, premolars,
 deciduous teeth



SSI-A-305
65
 upper incisors
 and roots

Щипцы экстракционные (американская форма)
 Daviers - forme americane
 Fórceps de extracción - forma americana

Щипці екстракційні (американська форма)
 Pinzere per estrazione - forma americana
 استخراج الملقط (النمط الأمريكي)



SSI-A-306
69 Tomas
 upper and
 lower roots



SSI-A-307
85 Tomas
 lower canines,
 premolars and molars



SSI-A-308
88R Nevius
 upper molars,
 right



SSI-A-309
85A Tomas
 lower canines,
 premolars and molars



SSI-A-310
88L Nevius
 upper molars,
 left

EXTRACTING FORCEPS (American Pattern)

Щипцы экстракционные (американская форма)
 Daviers - forme américaine
 Fórceps de extracción - forma americana

Щипці екстракційні (американська форма)
 Pinzere per estrazione - forma americana
 استخراج الملقط (التمط الأمريكي)

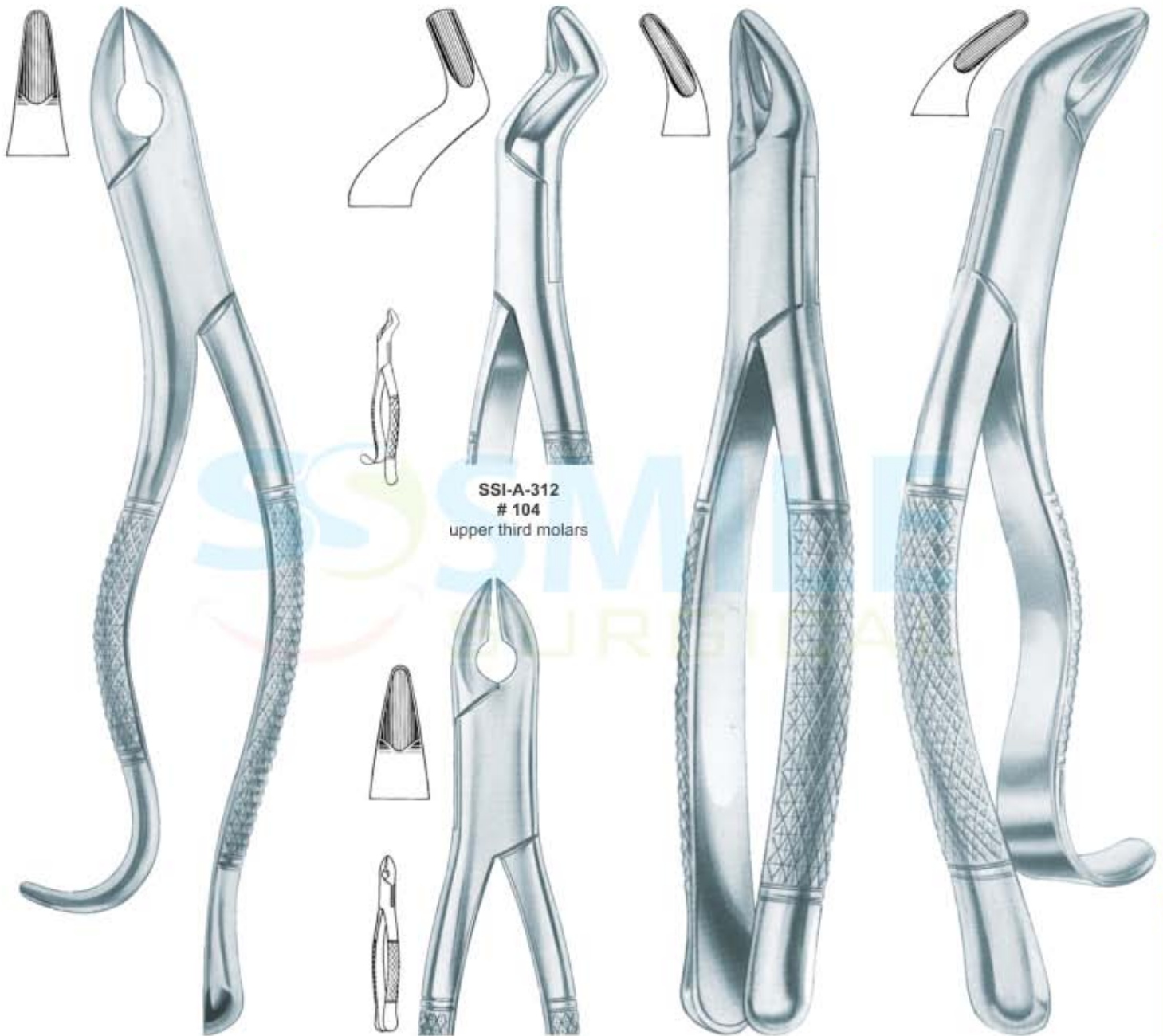

SSI-A-311
99A
Kells
 upper incisors,
 canines, premolars

SSI-A-313
99C
Kells
 upper incisors,
 canines, premolars

SSI-A-314
101
Hull
 Deciduous teeth

SSI-A-315
103
 lower incisors,
 premolars

Щипцы экстракционные (американская форма)
 Daviers - forme americane
 Fórceps de extracción - forma americana

Щипці екстракційні (американська форма)
 Pinzere per estrazione - forma americana
 استخراج الملقط (النمط الأمريكي)



SSI-A-316
150
Cryer
upper incisors,
premolars,
roots



SSI-A-317
150A
Cryer
upper incisors,
premolars,
roots



SSI-A-318
150S
Cryer
upper teeth,
for children



SSI-A-319
Fig. 150X
Upper premolars,
incisors and roots



SSI-A-323
151
Cryer
lower teeth,
for children



SSI-A-320
Fig. 150XAS
Upper premolars,
incisors and
roots -
also for children



SSI-A-321
151A
Cryer
lower incisors,
premolars,
roots



SSI-A-322
151 S
Cryer
lower incisors,
premolars,
roots

EXTRACTING FORCEPS (American Pattern)

Щипцы экстракционные (американская форма)
 Daviers - forme américaine
 Fórceps de extracción - forma americana

Щипці екстракційні (американська форма)
 Pinzoper per estrazione - forma americana
 استخراج الملقط (التمط الأمريكي)



SSI-A-324
203
 lower incisors
 and roots

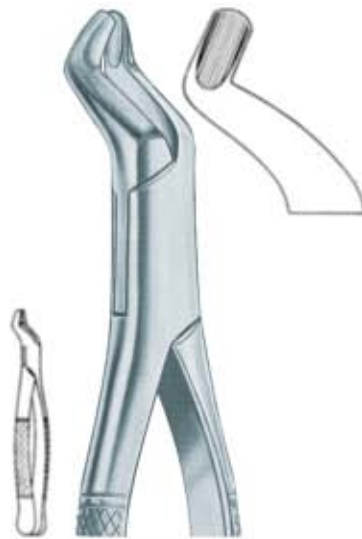

SSI-A-325
210S
 upper third
 molars



SSI-A-326
201
 lower incisors,
 canines,
 premolars



SSI-A-327
210H
 upper third
 molars

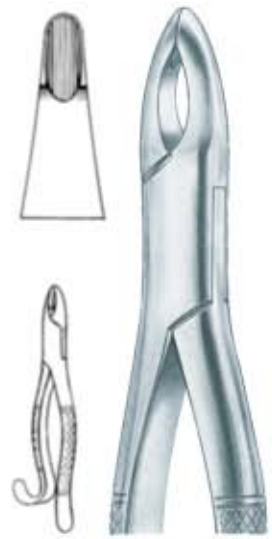

SSI-A-328
213
 upper centrals
 and canines

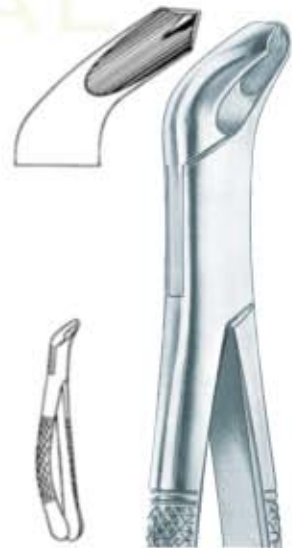

SSI-A-329
217
 lower molars

Щипцы экстракционные (американская форма)
 Daviers - forme américaine
 Fórceps de extracción - forma americana

Щипці екстракційні (американська форма)
 Pinzere per estrazione - forma americana
 استخراج الملقط (النمط الأمريكي)



SSI-A-330
222
 lower third molars



SSI-A-331
286
 upper incisors
 and roots



SSI-A-332
287 Swing
 lower molars



SSI-A-333
288
 Lower canines
 and premolars

EXTRACTING FORCEPS (American Pattern)

Щипцы экстракционные (американская форма)
 Daviers - forme americane
 Fórceps de extracción - forma americana

Щипці екстракційні (американська форма)
 Pinzoper per estrazione - forma americana
 استخراج الملقط (التمط الأمريكي)



SSI-A-334
Cohen
 universal forceps

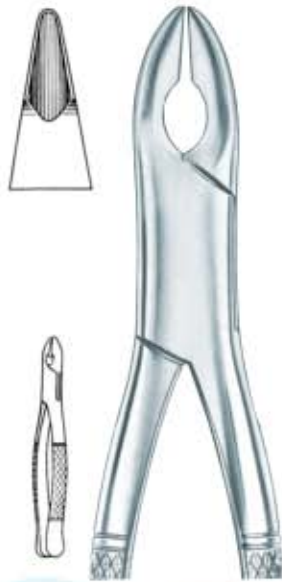

SSI-A-335
10 S Nevius
 upper canines



SSI-A-336
1 A Henahan
 upper incisors



SSI-A-337
10 H Nevius
 upper canines



SSI-A-338
4 Standard
 upper third molars

Щипцы экстракционные (американская форма)
 Daviers - forme américaine
 Fórceps de extracción - forma americana

Щипці екстракційні (американська форма)
 Pinzere per estrazione - forma americana
 استخراج الملقط (النمط الأمريكي)



SSI-A-339
FH Woodward
 Lower molars



SSI-A-340
FS Woodward
 Lower molars



SSI-A-341
89
 Upper molars,
 right



SSI-A-342
90
 Upper molars,
 left

EXTRACTING FORCEPS (American Pattern)

Щипцы экстракционные (американская форма)
 Daviers - forme americane
 Fórceps de extracción - forma americana

Щипці екстракційні (американська форма)
 Pinzoper per estrazione - forma americana
 استخراج الملقط (التمط الأمريكي)



SSI-A-343
23 S
 Lower molars



SSI-A-344
17 SK
 Lower molars



SSI-A-345
150 SK
 Upper anteriors
 and roots



SSI-A-346
151 SK
 lower anteriors
 and roots

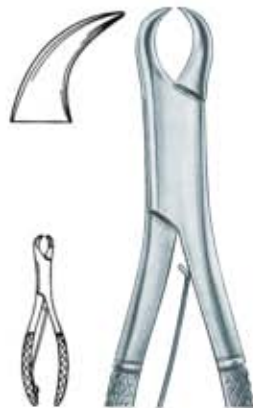

SSI-A-347
23 SK
 Lower molars



SSI-A-348
Fig. 49S
 Extracting Forceps
 For Lower Molars
 Spacial Design



SSI-A-349
Fig. 51E
 Extracting Forceps
 For Upper Molars
 Spacial Design



SSI-A-350
Fig. 51ES
 Extracting Forceps
 For Upper Molars
 Spacial Design



Щипцы экстракционные (с эргономичной формой ручки)
 Daviers (avec manche d'ajustage)
 Zahnzangen (mit Paßformgriff)

Щипці екстракційні (з ергономічною формою ручки)
 Forceps de Extracción (con mango adaptado a la mano)
 استخراج المنطق (مع تركيب مقابض)



SSI-A-351
1
upper laterals
and canines



SSI-A-352
2
upper laterals
and canines



SSI-A-353
3
upper incisors
and canines

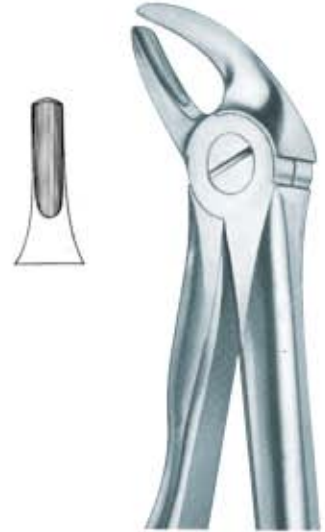

SSI-A-354
4
lower incisors
and canines



SSI-A-355
7
upper premolars



SSI-A-356
13
lower premolars



SSI-A-357
13 S
lower premolars,
for children

EXTRACTING FORCEPS (Anatomical Handle)

Щипцы экстракционные (с эргономичной формой ручки)
 Daviers (avec manche d'ajustage)
 Zahnzangen (mit Paßformgriff)

Щипці екстракційні (з ергономічною формою ручки)
 Forceps de Extracción (con mango adaptado a la mano)
 استخراج الملقط (مع تركيب مقابض)



SSI-A-358
17
 upper molars,
 right



SSI-A-359
18
 upper molars,
 left



SSI-A-360
18 A
 upper molars



SSI-A-361
18 B
 upper molars



SSI-A-362
19
 upper third molars



SSI-A-363
22
 lower molars



SSI-A-364
22 S
 lower molars,
 for children

EXTRACTING FORCEPS (Anatomical Handle)

Щипцы экстракционные (с эргономичной формой ручки)
 Daviers (avec manche d'ajustage)
 Zahnzangen (mit Paßformgriff)

Щипці екстракційні (з ергономічною формою ручки)
 Forceps de Extracción (con mango adaptado a la mano)
 استخراج المنطق (مع تركيب مقابض)



SSI-A-365
29
upper roots



SSI-A-366
29 S
upper roots,
for children



SSI-A-367
30
upper roots



SSI-A-368
30 S
upper roots,
for children



SSI-A-369
33
lower roots



SSI-A-370
33 A
lower roots



SSI-A-371
33 B
lower roots

EXTRACTING FORCEPS (Anatomical Handle)

Щипцы экстракционные (с эргономичной формой ручки)
 Daviers (avec manche d'ajustage)
 Zahnzangen (mit Paßformgriff)

Щипці екстракційні (з ергономічною формою ручки)
 Forceps de Extracción (con mango adaptado a la mano)
 استخراج الملقط (مع تركيب مقابض)



SSI-A-372
33 L
 lower roots



SSI-A-373
33 S
 lower roots,
 for children



SSI-A-374
37
 upper incisors,
 for children



SSI-A-375
39
 upper molars,
 for children



SSI-A-376
39 A
 upper molars,
 for children



SSI-A-377
39 R
 upper molars right,
 for children



SSI-A-378
39 L
 upper molars left,
 for children

EXTRACTING FORCEPS (Anatomical Handle)

Щипцы экстракционные (с эргономичной формой ручки)
 Daviers (avec manche d'ajustage)
 Zahnzangen (mit Paßformgriff)

Щипці екстракційні (з ергономічною формою ручки)
 Forceps de Extracción (con mango adaptado a la mano)
 استخراج المنطق (مع تركيب مقابض)



SSI-A-379
41
upper roots



SSI-A-380
44
upper roots



SSI-A-381
45
lower roots



SSI-A-382
48
lower roots

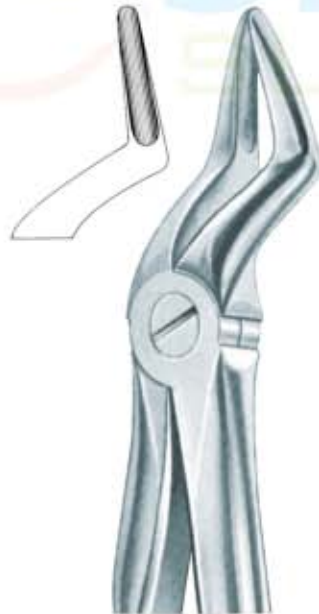

SSI-A-383
51
upper roots



SSI-A-384
51 A
upper roots



SSI-A-385
51 S
upper roots,

EXTRACTING FORCEPS (Anatomical Handle)

Щипцы экстракционные (с эргономичной формой ручки)
 Daviers (avec manche d'ajustage)
 Zahnzangen (mit Paßformgriff)

Щипці екстракційні (з ергономічною формою ручки)
 Forceps de Extracción (con mango adaptado a la mano)
 استخراج الملقط (مع تركيب مقابض)



SSI-A-386
51 L
 upper roots



SSI-A-387
52
 upper roots



SSI-A-388
54
 for separating
 upper molars



SSI-A-389
65 R
 upper molars,
 right



SSI-A-390
65 L
 upper molars, left



SSI-A-391
67
 upper third molars



SSI-A-392
67 A
 upper third molars

Щипцы экстракционные (с эргономичной формой ручки)
 Daviers (avec manche d'ajustage)
 Zahnzangen (mit Paßformgriff)

Щипці екстракційні (з ергономічною формою ручки)
 Forceps de Extracción (con mango adaptado a la mano)
 استخراج المنطق (مع تركيب مقابض)



SSI-A-393
67 1/2 R
 upper third molars,
 right

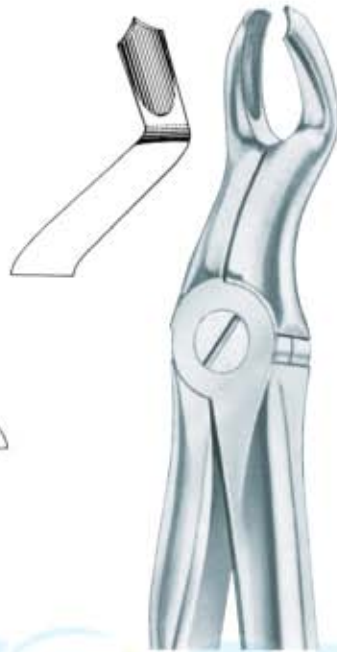

SSI-A-394
67 1/2 L
 lower third molars,
 left.



SSI-A-395
73
 lower molars



SSI-A-396
74
 lower roots



SSI-A-397
74 M
 lower roots



SSI-A-398
74 N
 lower roots



SSI-A-399
74 XN
 lower roots and crowded
 incisors

EXTRACTING FORCEPS (Anatomical Handle)

Щипцы экстракционные (с эргономичной формой ручки)
 Daviers (avec manche d'ajustage)
 Zahnzangen (mit Paßformgriff)

Щипці екстракційні (з ергономічною формою ручки)
 Forceps de Extracción (con mango adaptado a la mano)
 استخراج الملقط (مع تركيب مقابض)



SSI-A-400
75
 lower premolars



SSI-A-401
76
 upper roots



SSI-A-402
76N
 upper roots



SSI-A-403
81
 lower premolars
 and roots



SSI-A-404
79A
 lower third molars



SSI-A-405
79
 lower third molars

Щипцы экстракционные (с эргономичной формой ручки)
 Daviers (avec manche d'ajustage)
 Zahnzangen (mit Paßformgriff)

Щипці екстракційні (з ергономічною формою ручки)
 Forceps de Extracción (con mango adaptado a la mano)
 استخراج المنطق (مع تركيب مقابض)



SSI-A-406
86 A
lower molars



SSI-A-407
86 B
lower molars



SSI-A-408
86 C
lower molars



SSI-A-409
99
lower molars



SSI-A-410
99 1/4
lower molars



SSI-A-411
136
upper premolars
and roots



SSI-A-412
143
lower molars

EXTRACTING FORCEPS (American Pattern Hole Handle)

Щипцы экстракционные (американская форма)
Daviers - forme américaine
Fórceps de extracción - forma americana

Щипці екстракційні (американська форма)
Pinzere per estrazione - forma americana
ستخراج الملقط (النمط الأمريكي)



SSI-A-413
Fig. 1
Upper Anterior



SSI-A-414
Lower Molar
Fig. 23 Cow Horn



SSI-A-415
Fig. 88L
Upper Molar Left



SSI-A-416
Fig. 88R
Upper Molar Right



SSI-A-417
Fig. 150
Upper Universal

EXTRACTING FORCEPS (American Pattern Hole Handle)

Щипцы экстракционные (американская форма)
 Daviers - forme américaine
 Fórceps de extracción - forma americana

Щипці екстракційні (американська форма)
 Pinzere per estrazione - forma americana
 استخراج الملقط (النمط الأمريكي)



SSI-A-418
Fig. 150S
Upper Universal



SSI-A-419
Fig. 151
Lower Universal



SSI-A-420
Fig. 151S
Lower Universal



SSI-A-421
Fig. 106
Lower Incisors



SSI-A-422
Fig. 174
Extra Narrow Lower Anterior
Apical Retention Forceps

EXTRACTING FORCEPS (English Pattern)



- Щипцы экстракционные (английская форма)
- Daviers (Forme Anglaise)
- Zahnzangen (Englische Form)

- Щипці екстракційні (англійська форма)
- Forceps de Extracció (Forme Inglesa)
- استخراج الملقط (نمط الفة الإنجليزية)

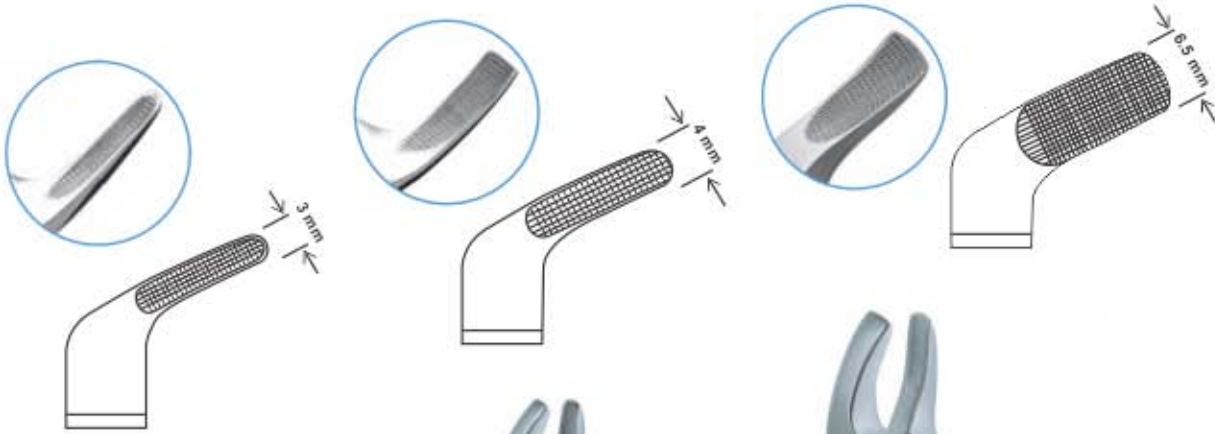

SSI-A-423
Meissner
Extracting Forceps



SSI-A-424
Meissner
Extracting Forceps



SSI-A-425
Meissner
Extracting Forceps



SSI-A-426
Comellas Forceps
Anatomical Handle



Please Ask For Special Packing of Extracting Forceps Above

PREMIUM QUALITY DENTAL INSTRUMENTS

- Извлечение щипцов
- Ensemble de pinces d'extraction
- Zange sammeln
- Витягуючий комплект щипців
- Extracción del conjunto de fórceps
- استخراج منقذ مجموعة

For Special Packing of Extracting Forceps Please Ask



- SSI-A-427**
Extracting Forceps
Anatomical Handle
Set of 10 Pieces
Extracting Forceps Fig. 1
Extracting Forceps Fig. 7
Extracting Forceps Fig. 13
Extracting Forceps Fig. 17
Extracting Forceps Fig. 18
Extracting Forceps Fig. 22
Extracting Forceps Fig. 33A
Extracting Forceps Fig. 51A
Extracting Forceps Fig. 67A
Extracting Forceps Fig. 79



SSI-A-428
Extracting Forceps
Anatomical Handle (Black Coated)
Set of 10 Pieces

- Set of 10 Pieces
Extracting Forceps Fig. 1
Extracting Forceps Fig. 7
Extracting Forceps Fig. 13
Extracting Forceps Fig. 17
Extracting Forceps Fig. 18
Extracting Forceps Fig. 22
Extracting Forceps Fig. 33A
Extracting Forceps Fig. 51A
Extracting Forceps Fig. 67A
Extracting Forceps Fig. 79



SSI-A-429
Extracting Forceps
Anatomical Handle (Titanium Coated)
Set of 10 Pieces

- Извлечение щипцов
- Ensemble de pinces d'extraction
- Zange sammeln
- Витягуючий комплект щипців
- Extracción del conjunto de fórceps
- استخراج منقذ مجموعة

For Special Packing of Extracting Forceps Please Ask



- SSI-A-430**
Extracting Forceps
English Pattern
Set of 10 Pieces
Extracting Forceps Fig. 1
Extracting Forceps Fig. 7
Extracting Forceps Fig. 13
Extracting Forceps Fig. 17
Extracting Forceps Fig. 18
Extracting Forceps Fig. 22
Extracting Forceps Fig. 33A
Extracting Forceps Fig. 51A
Extracting Forceps Fig. 67A
Extracting Forceps Fig. 79



- SSI-A-431**
Extracting Forceps
English Pattern (Black Coated)
Set of 10 Pieces

- Set of 10 Pieces
Extracting Forceps Fig. 1
Extracting Forceps Fig. 7
Extracting Forceps Fig. 13
Extracting Forceps Fig. 17
Extracting Forceps Fig. 18
Extracting Forceps Fig. 22
Extracting Forceps Fig. 33A
Extracting Forceps Fig. 51A
Extracting Forceps Fig. 67A
Extracting Forceps Fig. 79



- SSI-A-432**
Extracting Forceps
English Pattern (Titanium Coated)
Set of 10 Pieces

- Извлечение щипцов
- Ensemble de pinces d'extraction
- Zange sammeln
- Витягуючий комплект щипців
- Extracción del conjunto de fórceps
- استخراج منقذ مجموعة

For Special Packing of Extracting Forceps Please Ask



- SSI-A-433**
Extracting Forceps (English Pattern)
Set of 10 Pieces
Extracting Forceps Fig. 1
Extracting Forceps Fig. 7
Extracting Forceps Fig. 13
Extracting Forceps Fig. 17
Extracting Forceps Fig. 18
Extracting Forceps Fig. 22
Extracting Forceps Fig. 33A
Extracting Forceps Fig. 51A
Extracting Forceps Fig. 67A
Extracting Forceps Fig. 79



- SSI-A-434**
Extracting Forceps (Anatomical Handle)
Set of 10 Pieces
Extracting Forceps Fig. 1
Extracting Forceps Fig. 7
Extracting Forceps Fig. 13
Extracting Forceps Fig. 17
Extracting Forceps Fig. 18
Extracting Forceps Fig. 22
Extracting Forceps Fig. 33A
Extracting Forceps Fig. 51A
Extracting Forceps Fig. 67A
Extracting Forceps Fig. 79



- SSI-A-435**
Extracting Forceps (Hole Pattern Handle)
Set of 10 Pieces
Extracting Forceps Fig. 1
Extracting Forceps Fig. 7
Extracting Forceps Fig. 13
Extracting Forceps Fig. 17
Extracting Forceps Fig. 18
Extracting Forceps Fig. 22
Extracting Forceps Fig. 33A
Extracting Forceps Fig. 51A
Extracting Forceps Fig. 67A
Extracting Forceps Fig. 79

- Извлечение щипцов
- Ensemble de pinces d'extraction
- Zange sammeln
- Витягуючий комплект щипців
- Extracción del conjunto de fórceps
- استخراج منقذ مجموعة

For Special Packing of Extracting Forceps Please Ask



- SSI-A-436**
Extracting Forceps (English Pattern)
Set of 13 Pieces
- Extracting Forceps Fig. 2
 - Extracting Forceps Fig. 7
 - Extracting Forceps Fig. 13
 - Extracting Forceps Fig. 17
 - Extracting Forceps Fig. 18
 - Extracting Forceps Fig. 22
 - Extracting Forceps Fig. 33
 - Extracting Forceps Fig. 51A
 - Extracting Forceps Fig. 67A
 - Extracting Forceps Fig. 79
 - Extracting Forceps Fig. 86C
 - Extracting Forceps Fig. 89
 - Extracting Forceps Fig. 90



- SSI-A-437**
Extracting Forceps (English Pattern)
Set of 10 Pieces
- Extracting Forceps Fig. 13S
 - Extracting Forceps Fig. 22S
 - Extracting Forceps Fig. 30S
 - Extracting Forceps Fig. 33S
 - Extracting Forceps Fig. 37
 - Extracting Forceps Fig. 38
 - Extracting Forceps Fig. 39
 - Extracting Forceps Fig. 39L
 - Extracting Forceps Fig. 39R
 - Extracting Forceps Fig. 51S

- Извлечение щипцов
- Витягуючі комплекти щипців
- Kits de forceps d'extracteurs
- Extracción de kits de fórceps
- Zangen ausziehen
- استخراج ملقط اطقم



SSI-A-438
Set of 37 Pcs

- 01 - Extracting Forceps Fig.1 1
- 02 - Extracting Forceps Fig.7 1
- 03 - Extracting Forceps Fig.13 1
- 04 - Extracting Forceps Fig.17 1
- 05 - Extracting Forceps Fig.18 1
- 06 - Extracting Forceps Fig.18A 1
- 07 - Extracting Forceps Fig.19 1
- 08 - Extracting Forceps Fig.20 1
- 09 - Extracting Forceps Fig.22 1
- 10 - Extracting Forceps Fig.29 1
- 11 - Extracting Forceps Fig.33 1
- 12 - Extracting Forceps Fig.51 1
- 13 - Extracting Forceps Fig.51A 1
- 14 - Extracting Forceps Fig.67A 1
- 15 - Extracting Forceps Fig.79 1
- 16 - Extracting Forceps Fig.136 1
- 17 - Extracting Forceps Fig.137 1
- 18 - Extracting Forceps Fig.53 L 1
- 19 - Extracting Forceps Fig.53 R 1
- 20 - Extracting Forceps Fig.65 1
- 21 - Root Elevators Fig.1B 1
- 22 - Root Elevators Fig.3B 1
- 23 - Root Elevators Fig.5B 1
- 24 - Root Elevators Fig.4B SA Apexo 1
- 25 - Root Elevators Fig.5B SA Apexo 1
- 26 - Cotton Tweezers 1
- 27 - Mouth Mirrors With Handles Fig.5 1
- 28 - Explorers 1
- 29 - Cement Spatulas 1
- 30 - Filling Instruments 1
- 31 - Filling Instruments 1
- 32 - Filling Instruments 1
- 33 - Filling Instruments 1
- 34 - Gum Scissors 1
- 35 - Excavators 1
- 36 - Bone Curettes 1
- 37 - Dental Aspirated Syringes 1



SSI-A-439 Available in Gold Coated Set of 25 Pcs
SSI-A-440 Available in Polish Set of 25 Pcs

- 01 - Extracting Forceps Fig.13 1
- 02 - Extracting Forceps Fig.17 1
- 03 - Extracting Forceps Fig.18 1
- 04 - Extracting Forceps Fig.19 1
- 05 - Extracting Forceps Fig.20 1
- 06 - Extracting Forceps Fig.22 1
- 07 - Extracting Forceps Fig.29 1
- 08 - Extracting Forceps Fig.33 1
- 09 - Extracting Forceps Fig.51 1
- 10 - Extracting Forceps Fig.51A 1
- 11 - Extracting Forceps Fig.67A 1
- 12 - Extracting Forceps Fig.79 1
- 13 - Root Elevators Fig.1B 1
- 14 - Root Elevators Fig.3B 1
- 15 - Root Elevators Fig.4B SA Apexo 1
- 16 - Root Elevators Fig.5B SA Apexo 1
- 17 - Cotton Tweezers 1
- 18 - Mouth Mirrors With Handles 1
- 19 - Explorers 1
- 20 - Cement Spatulas 1
- 21 - Filling Instruments 1
- 22 - Filling Instruments 1
- 23 - Filling Instruments 1
- 24 - Excavators 1
- 25 - Dental Aspirated Syringes 1

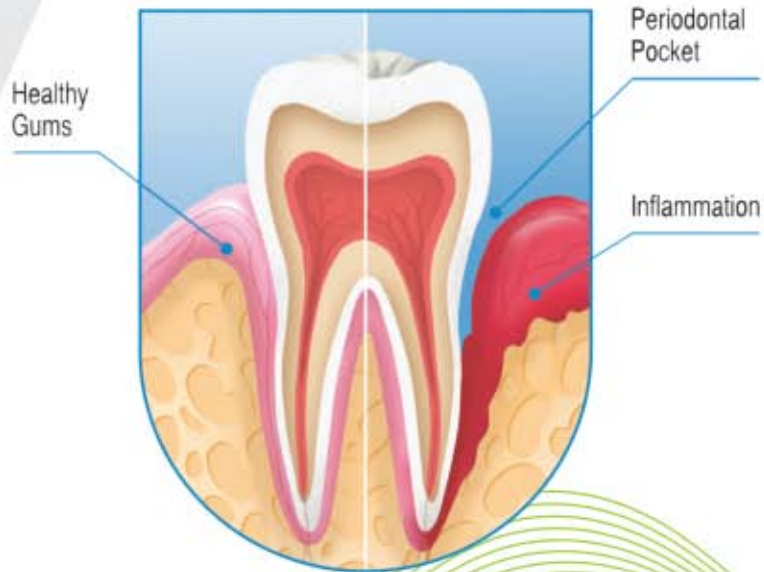

HANDLES OPTIONS FOR ROOT ELEVATORS A, B, C, D, E, F, G



Dental Root Elevators

To look at one of these instruments you might mistake it for a narrow screwdriver.

That's because just like one an elevator has a handle and then a specially designed "blade" or tip portion.

How they're used.

The tip of an elevator is designed to be wedged into the ligament space between a tooth and its surrounding bone (as shown in our animation).

As the elevator is forced into and twisted around in this space, the tooth is rocked around and pressed against the walls of its socket.

This helps to both expand the shape of the socket and separate the tooth from its ligament.

As this work is continued, the tooth gradually becomes more and more mobile.

In some cases, the dentist may be able to completely remove the tooth just using their elevator.

If not, they will choose a point where they feel they have accomplished as much as they can with it and will then switch to using extraction forceps.

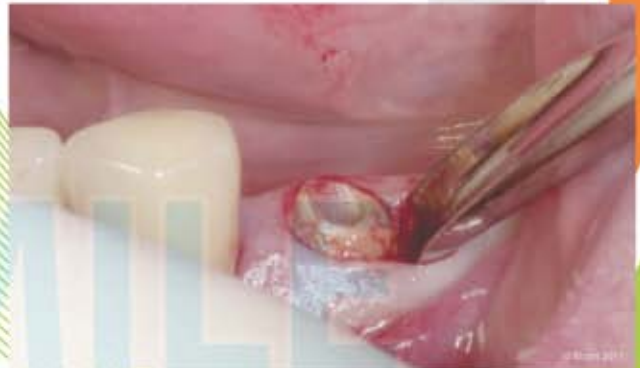

■ Элеватор корневой экстракционный ■ Слеватор корневий экстракційний
■ Elévateurs à racines ■ Elevadores para raíces
■ Wurzelheber ■ المصاعد الجذر



SSI-B-001
1
straight
Bein



SSI-B-002
Fig. 1B
Bein



SSI-B-003
Fig. 2B
Bein



SSI-B-004
Fig. 3B
Bein



SSI-B-005
Fig. 4B
Bein



SSI-B-006
Fig. 5B
Bein



SSI-B-007
Fig. 6B
Bein



SSI-B-008
Fig. 4
straight



SSI-B-009
White



SSI-B-010
White



SSI-B-011
Berten



SSI-B-012
Fig. 2
Bein



SSI-B-013
Fig. 3
Bein



SSI-B-014
Fig. 4
Bein



SSI-B-015
Fig. 1
Bein



SSI-B-016
Fig. 2
Bein

Элеватор корневой экстракционный
Elévateurs à racines
Wurzelheber

Слеватор корневий экстракційний
Elevadores para raices
المصاعد الجذر

Atraumatic Extraction Elevators & Socket Scoops
Socket Scoops For Cleaning Out Extraction Sites



SSI-B-017
Fig. 4B SA
Schmeckeblie Apexo
Concave tip



SSI-B-018
Fig. 5B SA
Schmeckeblie
Apexo
Concave tip



SSI-B-019
Fig. 4 SA
Schmeckeblie
Apexo
Flat tip



SSI-B-020
Fig. 5 SA
Schmeckeblie
Apexo
Flat tip



SSI-B-021
Misch Socket Scoop
4mm Angled Left

SSI-B-022
Misch Socket Scoop
4mm Angled Right



SSI-B-023
Potts Elevator-
Left



SSI-B-024
Potts Elevator-
Right



SSI-B-025
Potts "T-Handle"
Elevator-Left



SSI-B-026
Potts "T-Handle"
Elevator-Right

- Элеватор корневой экстракционный
- Слеватор кореневий екстракційний
- Elévateurs à racines
- Elevadores para raices
- Wurzelheber
- المصاعد الجذر

Apexo Root Elevators



Apexo Root Elevator

- | | | | | | |
|--|--|--|--|--|--|
| | | | | | |
| SSI-B-027
Apexo
2.5x9mm
Straight | SSI-B-028
Apexo
2.7x9mm
Straight | SSI-B-029
Apexo
3.0x9mm
Straight | SSI-B-030
Apexo
2.5x9mm
Curved | SSI-B-031
Apexo
3.0x9mm
Curved | SSI-B-032
Seldin
3.0x14mm
Straight |

FUNCTION: To loosen tooth or root from bony socket prior to placement of the extraction forceps.



Luxator Root Elevators



Luxator Root Elevator

- | | | | | | | | |
|--|--|--|--|--|--|--|--|
| | | | | | | | |
| SSI-B-033
Luxator
2mm
straight | SSI-B-034
Luxator
2mm
curved | SSI-B-035
Luxator
3mm
straight | SSI-B-036
Luxator
3mm
curved | SSI-B-037
Luxator
4mm
straight | SSI-B-038
Luxator
4mm
curved | SSI-B-039
Luxator
5mm
straight | SSI-B-040
Luxator
5mm
curved |

- Элеватор корневой экстракционный
 ■ Elevator coronevii ekstraktsionniy
- Elévateurs à racines
 ■ Elevadores para raíces
- Wurzelheber
 ■ المصاعد الجذر

Bein Root Elevators



Bein
Root Elevator

3.0mm



SSI-B-041
Bein
Fig. 1B

4.0mm



SSI-B-042
Bein
Fig. 2B

3.0mm



SSI-B-043
Bein
Fig. 3B

4.0mm



SSI-B-044
Bein
Fig. 4B

3.2mm



SSI-B-045
Bein
Fig. 5B

3.8mm



SSI-B-046
Bein
Fig. 6B



Seldin Root Elevators



Seldin
Root Elevator

4 mm



SSI-B-047
Seldin 34S

5 mm



SSI-B-048
Seldin 34

10 mm



SSI-B-049
Seldin 4L
(Left)

10 mm



SSI-B-050
Seldin 4R
(Right)

13 mm



SSI-B-051
Seldin 1L
(Left)

13 mm



SSI-B-052
Seldin 1R
(Right)

3.5mm



SSI-B-053
Seldin

- Elevator корневой экстракционный
- Elévateurs à racines
- Wurzelheber
- Elevator корневой экстракционный
- Elevadores para raices
- المصاعد الجذر

Flohr Root Elevators



Coupland Root Elevators



Apical Root Elevators



Apical Root Elevators

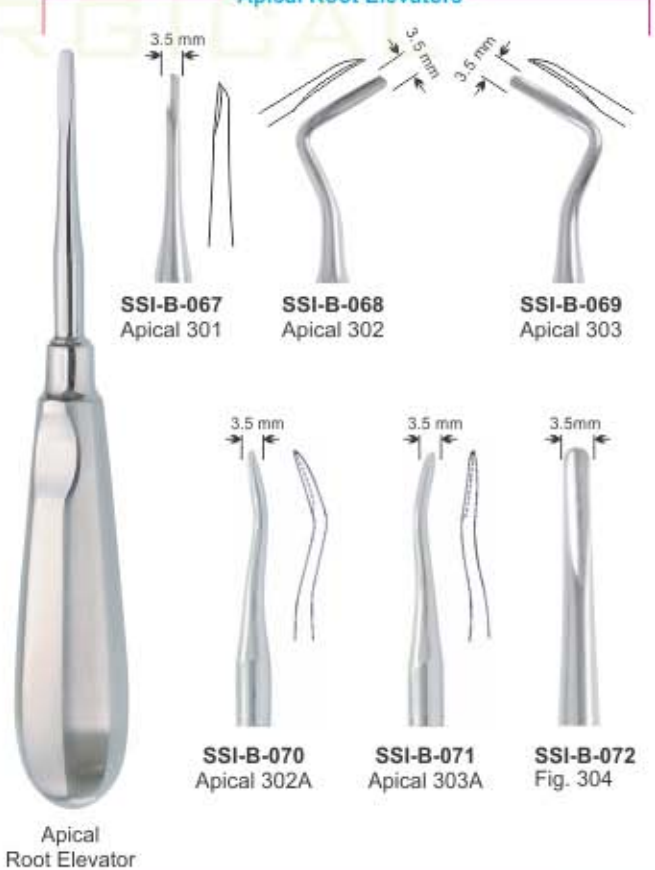

■ Elevator корневой экстракционный
■ Elévateurs à racines
■ Wurzelheber

■ Elevator coronevii ekstraktsionniy
■ Elevadores para raices
■ المصاعد الجذر

Laxutor Root Elevators

Long Type



Laxutor
Root Elevator



SSI-B-073
Laxutor
1.5mm
Str.



SSI-B-074
Laxutor
2mm
Str.



SSI-B-075
Laxutor
3mm
Str.



SSI-B-076
Laxutor
5mm
Str.



SSI-B-077
Laxutor
3mm
Cvd.

FUNCTION:

To loosen tooth or root from bony socket prior to placement of the extraction forceps.



SSI-B-078
Laxutor
5mm
Cvd.



SSI-B-079
Laxutor
3mm
Upper
Angle



SSI-B-080
Laxutor
3mm
Double
Angle



SSI-B-081
Laxutor
3mm
Str.



SSI-B-082
Laxutor
5mm
Str.

- Elevator корневой экстракционный
- Elevator coronevii ekstraktsionnyy
- Elévateurs à racines
- Elevadores para raíces
- Wurzelheber
- المصاعد الجذر

Cryer Root Elevators



Cryer Root Elevator



Miller Root Elevators



SSI-B-089 Miller 1

SSI-B-090 Miller 2

SSI-B-091 Miller 3 Left

SSI-B-092 Miller 3 Right

- Элеватор корневой экстракционный
- Elévateurs à racines
- Wurzelheber
- Elevator coronevii ekstraktsionnyy
- Elevadores para raices
- المصاعد الجذر

Lindo Levian Root Elevators



Lindo Levian Root Elevator

SSI-B-093 Fig. 25 Lindo-Levien 2.5x5mm straight	SSI-B-094 Fig. 35 Lindo-Levien 3x8mm straight	SSI-B-095 Fig. 45 Lindo-Levien 4x8mm straight	SSI-B-096 Fig. 1 Lindo-Levien 2.5x5 curved	SSI-B-097 Fig. 2 Lindo-Levien 3x8 curved	SSI-B-098 Fig. 3 Lindo-Levien 4x8 curved	SSI-B-099 Lindo-Levien Serrated Left Curved	SSI-B-100 Lindo-Levien Serrated Right Curved



Friedmann Roots Elevator

SSI-B-101 Fig. 1 Friedman Str.	SSI-B-102 Fig. 2 Friedman Left	SSI-B-103 Fig. 3 Friedman Right

Friedmann Roots Elevator

Heidbrink Root Elevators

SSI-B-104 Heidbrink No.1	SSI-B-105 Heidbrink No.3 (Left)	SSI-B-106 Heidbrink No.4 (Right)

Heidbrink Root Elevator

- Elevator корневой экстракционный
- Elevators à racines
- Wurzelheber
- Elevator корневий экстракційний
- Elevadores para raices
- المصاعد الجذر

Mesial & Distal Root Elevators



Root Elevators



SSI-B-107
Fig. 33
Mesial
2 mm

SSI-B-108
Fig. 34
Mesial
3 mm

SSI-B-109
Fig. 35
Mesial
4 mm

SSI-B-110
Fig. 36
Distal
2 mm

SSI-B-111
Fig. 37
Distal
3 mm

SSI-B-112
Fig. 38
Distal
4 mm

Apexo Root Elevators



SSI-B-113
Fig. 301
Apexo
2.5mm

SSI-B-114
Fig. 302
Apexo
2.5mm

SSI-B-115
Fig. 303
Apexo
2.5mm

SSI-B-116
Fig. 301W
Seldin
3mm

SSI-B-117
Fig. 304W
Seldin
3mm

Элеватор корневой экстракционный
Elévateurs à racines
Wurzelheber

Слеватор корневий екстракційний
Elevadores para raices
المصاعد الجذر

Wisdom Roots Elevator



SSI-B-118
Wisdom
for 18 and 38

SSI-B-119
Wisdom
for 28 and 48

Bayonet Roots Elevator Set



SSI-B-120
Left

SSI-B-121
Right

SSI-B-122
bayonet

SSI-B-123
Curved

SSI-B-124
Straight

Roots Elevator



SSI-B-126
Fig. 61

SSI-B-127
Fig. 62

SSI-B-128
Fig. 63

SSI-B-125
Fig. 60

Luxier Roots Elevator



SSI-B-129
Luxier
3mm, Straight

SSI-B-130
Luxier
3mm, Curved

SSI-B-131
Luxier
5mm, Stright

SSI-B-132
Luxier
3mm, Angular

■ Elevator корневой экстракционный
■ Elévateurs à racines
■ Wurzelheber

■ Elevator корневий экстракційний
■ Elevadores para raices
■ المصاعد الجذر

Hysin Roots Elevator

Coleman Root Elevator

SSI-B-133
 Hylin
 3mm
 Str.
 Overall length
 154mm

SSI-B-134
 Hylin
 4mm
 Str.

SSI-B-135
 Hylin
 3.5mm
 Left

SSI-B-136
 Hylin
 3.5mm
 Right

SSI-B-137
 Fig. 1
 London Hospital
 Coleman
 5mm

SSI-B-138
 Fig. 2
 London Hospital
 Coleman
 4mm

SSI-B-139
 Fig. 3
 London Hospital
 Coleman
 4mm

SSI-B-140
 Fig. 4
 London Hospital
 Coleman
 5mm

Molars Roots Elevator

Schlemmer Roots Elevator

SSI-B-141
 Molars Roots
 Left

SSI-B-142
 Molars Roots
 Right

Molars Roots

SSI-B-143
 Schlemmer
 Fig. 1

SSI-B-144
 Schlemmer
 Fig. 2

SSI-B-145
 Schlemmer
 Fig. 3

- Elevator корневой экстракционный
- Elevator корневий экстракційний
- Elévateurs à racines
- Elevadores para raíces
- Wurzelheber
- المصاعد الجذر

Medan Roots Elevator



Medan Roots Elevator

SSI-B-146 Bein 2.5mm	SSI-B-147 Bein 3mm Flat	SSI-B-148 Bein 3mm Round	SSI-B-149 Bein 3.5mm	SSI-B-150 Flohr 3.5mm (Left)	SSI-B-151 Flohr 3.5mm (Right)	SSI-B-152 Cryer 10mm (Left)	SSI-B-153 Cryer 10mm (Right)
	SSI-B-154 Seldin 4L (Left)	SSI-B-155 Seldin 4R (Right)		SSI-B-156 Seldin 1L (Left)	SSI-B-157 Seldin 1R (Right)		SSI-B-158 Seldin

Roots Elevator



SSI-B-159 Bein 2.5mm	SSI-B-160 Bein 3mm Flat	SSI-B-161 Bein 3mm Round	SSI-B-162 Bein 3.5mm	SSI-B-163 Flohr 3.5mm (Left)	SSI-B-164 Flohr 3.5mm (Right)	SSI-B-165 Cryer 10mm (Left)	SSI-B-166 Cryer 10mm (Right)
	SSI-B-167 Seldin 4L (Left)	SSI-B-168 Seldin 4R (Right)		SSI-B-169 Seldin 1L (Left)	SSI-B-170 Seldin 1R (Right)		SSI-B-171 Seldin

- Elevator корневой экстракционный
- Elevator coronevii ekstraktsionnyy
- Elévateurs à racines
- Elevadores para raíces
- Wurzelheber
- المصاعد الجذر



Root Elevators



SSI-B-172 Bein 2mm round
 SSI-B-173 Bein 3mm round
 SSI-B-174 Bein 4mm round
 SSI-B-175 Bein 2mm Flat
 SSI-B-176 Bein 3mm Flat
 SSI-B-177 Bein 4mm Flat
 SSI-B-178 White 4mm
 SSI-B-179 White 4mm



SSI-B-180 Berten 5mm Lower roots
 SSI-B-181 3mm
 SSI-B-182 3mm
 SSI-B-183 3mm
 SSI-B-184 3mm



SSI-B-185 Flohr 3mm



SSI-B-186 Flohr 3mm
 SSI-B-187 Flohr 3mm Flat
 SSI-B-188 Flohr 3mm Flat
 SSI-B-189 Cryer 10mm
 SSI-B-190 Cryer 10mm

FUNCTION: To loosen tooth or root from bony socket prior to placement of the extraction forceps.



Элеватор корневой экстракционный
Elévateurs à racines
Wurzelheber

Елеватор корневий екстракційний
Elevadores para raíces
المصاعد الجذر

Kopp Roots Elevator



SSI-B-191
Fig. 1
Kopp 3.6mm
Upper Roots



SSI-B-192
Fig. 2
Kopp 3.6mm
Upper Roots



SSI-B-193
Fig. 3
Kopp 4.2mm
Upper Roots



SSI-B-194
Fig. 4
Kopp 4.2mm
Upper Roots



SSI-B-195
Fig. 1
Kopp 3.6mm
Lower Roots



SSI-B-196
Fig. 2
Kopp 3.6mm
Lower Roots



SSI-B-197
Fig. 3
Kopp 4.2mm
Lower Roots



SSI-B-198
Fig. 4
Kopp 4.2mm
Lower Roots



Bein
SSI-B-199



Bein
SSI-B-200



Bein
SSI-B-201



Bein
SSI-B-202



Gartner
SSI-B-203



Gartner
SSI-B-204



Gartner
SSI-B-205



- Элеватор корневой экстракционный
 ■ Слеватор корневий екстракційний
- Elévateurs à racines
 ■ Elevadores para raíces
- Wurzelheber
 ■ المصاعد الجذر

Kopp Roots Elevator



SSI-B-206
Kopp
Right

SSI-B-207
Kopp
Left

Heber Roots Elevator



SSI-B-208
Heber
Bayonet

SSI-B-209
Heber
Bayonet

Bein Roots Elevator



SSI-B-210
Bein
3mm

SSI-B-211
Bein
4mm

Bein Roots Elevator



SSI-B-213
2mm
straight
serrated

SSI-B-214
3mm
straight

SSI-B-215
4mm
Curved

SSI-B-217
2mm
straight
serrated

SSI-B-218
3mm
straight

SSI-B-219
4mm
Curved

SSI-B-221
2mm
straight
serrated

SSI-B-222
3mm
straight

SSI-B-223
4mm
Curved

SSI-B-212
Bein
2mm, curved
serrated

SSI-B-216
Bein
2mm, curved
serrated

SSI-B-220
Bein
2mm, curved
serrated

-

Atraumatic Extraction Bayonet Root Elevators



SSI-B-224
3mm Luxating
Elevator Curved



SSI-B-225
3mm Luxating
Elevator Straight



SSI-B-226
5mm Luxating
Elevator Curved



SSI-B-227
5mm Luxating
Elevator Straight



SSI-B-228
2mm Grooved
Luxating Elevator



SSI-B-229
3mm Grooved
Luxating Elevator



SSI-B-230
4mm Grooved
Luxating Elevator



SSI-B-231
5mm Grooved
Luxating Elevator

- Elevator корневой экстракционный
 ■ Elevator корневий экстракційний
- Elévateurs à racines
 ■ Elevadores para raíces
- Wurzelheber
 ■ المصاعد الجذر

Luxating Elevator With Periotome Tip



SSI-B-232
3mm Luxating
Elevator / Periotome



SSI-B-233
4mm Luxating
Elevator / Periotome



SSI-B-234
5mm Luxating
Elevator / Periotome



SSI-B-235
Bayonet Elevator
Straight

Atraumatic Extraction Bayonet Root Elevators



SSI-B-236
Bayonet Elevator
Offset "In" Small



SSI-B-237
Bayonet Elevator
Offset "Out" Small



SSI-B-238
Bernard Bayonet
Elevator Offset Left



SSI-B-239
Bernard Bayonet
Elevator Offset Right

- Элеватор корневой экстракционный
- Єлеватор кореневий екстракційний
- Elévateurs à racines
- Elevadores para raíces
- Wurzelheber
- المصاعد الجذر

W. Barry Roots Elevator



SSI-B-240
W. Barry
Fig. 1



SSI-B-241
W. Barry
Fig. 2



SSI-B-242
W. Barry
Fig. 3



SSI-B-243
W. Barry
Fig. 4

Winter Roots Elevator



SSI-B-244
Winter
Fig. 1L



SSI-B-245
Winter
Fig. 1R



SSI-B-246
Winter
Fig. 11L



SSI-B-247
Winter
Fig. 11R



SSI-B-248
Winter
Fig. 12L



SSI-B-249
Winter
Fig. 12R

Pott Roots Elevator



SSI-B-250
Winter
Fig. 1L



SSI-B-251
Winter
Fig. 1R



SSI-B-252
Lecluse
bayonet



SSI-B-253
Pott
Left



SSI-B-254
Pott
Right

- Elevator корневой экстракционный
- Elevateurs à racines
- Wurzelheber
- Elevator coronevii ekstraktsionnyy
- Elevadores para raices
- المصاعد الجذر

Heidbrink Roots Elevator



SSI-B-255 Heidbrink Straight
 SSI-B-256 Heidbrink Left
 SSI-B-257 Heidbrink Right
 SSI-B-258 Heidbrink Straight
 SSI-B-259 Heidbrink Left
 SSI-B-260 Heidbrink Right

Syndesmotomes Roots Elevator



SSI-B-261 Straight
 SSI-B-262 Left
 SSI-B-263 Right

Periotome Roots Elevator

Syndesmotomes



SSI-B-264 Periotome 2.1mm Straight
 SSI-B-265 Periotome 2.6mm Straight
 SSI-B-266 Periotome 2.1mm Angular
 SSI-B-267 Periotome 2mm Curved
 SSI-B-268 Periotome 2.0mm
 SSI-B-269 Periotome 2.5mm
 SSI-B-270 Periotome 3.0mm
 SSI-B-271 Periotome 4.0mm
 SSI-B-272 Fig. 1

8mm

Heidebrink Root tip Picks



SSI-B-273 Fig. 2 Left
 SSI-B-274 Fig. 3 Right

- Elevator корневой экстракционный
- Elevator coronevii ekstraktsionniy
- Elévateurs à racines
- Elevadores para raíces
- Wurzelheber
- المصاعد الجذر

FUNCTION: To loosen small root fragments from bony socket

Heidbrink Roots Elevator

Warwick-James



SSI-B-276
Heidbrink
Root Apex
Elevator
(Left)

SSI-B-277
Heidbrink
Root Apex
Elevator
(Right)

SSI-B-275
Heidbrink
Root Apex
Elevator

SSI-B-278

SSI-B-279

SSI-B-280

SSI-B-281
Fig. 2

SSI-B-282
Fig. 1

SSI-B-283
Fig. 3

- Elevator корневой экстракционный
- Elevator coronevii ekstraktsionnyy
- Elévateurs à racines
- Elevadores para raíces
- Wurzelheber
- المصاعد الجذر

SYNDESMOTOMES



SSI-B-284
Fig. 1
Chompret



SSI-B-285
Fig. 2
Chompret



SSI-B-286
Fig. 3
Chompret



SSI-B-287
Fig. 4
Chompret



For Special Packing of Root Elevator Please Ask



SSI-B-288
Root Elevators Set of 6 Pcs
Bein 3mm
Bein 5mm
Cryer 31
Cryer 32
Apical 302
Apical 303



SSI-B-289
Root Elevators Set of 6 Pcs
Bein 3mm
Bein 5mm
Cryer 31
Cryer 32
Flohr Fig. 2
Flohr Fig. 3

Элеватор корневой экстракционный
Elévateurs à racines
Wurzelheber

Елеватор корневий екстракційний
Elevadores para raices
المساعد الجذر



SSI-B-290
Set of 5



Coupland

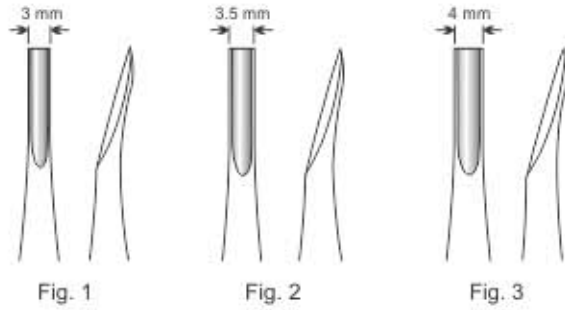

Schmeckeber

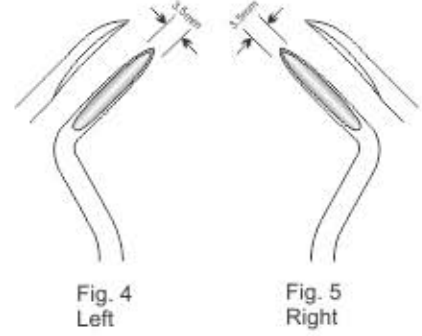

SSI-B-291
Set of 6



Seldin

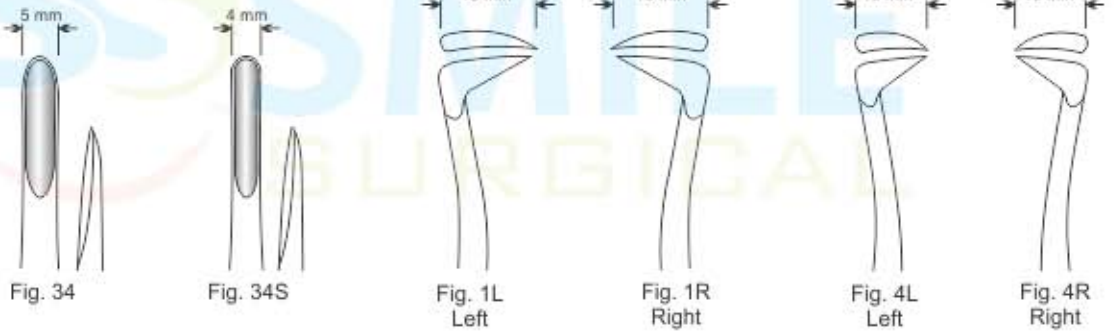

SSI-B-292
Set of 6



Cryer

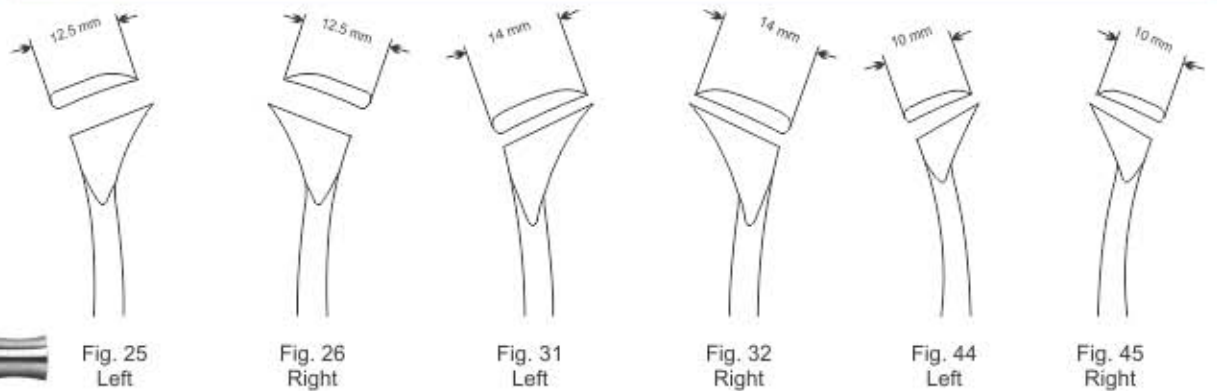

- Elevator corneвой экстракционный / Elevator corneвий экстракційний
- Elévateurs à racines / Elevadores para raices
- Wurzelheber / المصاعد الجذر



SSI-B-293
Root Elevators Set of 2 Pcs
Apical 302
Apical 303



SSI-B-294
Root Elevators Set of 2 Pcs
Flohr Fig. 2 3.5mm
Flohr Fig. 3 3.5mm



SSI-B-295
Root Elevators Set of 2 Pcs
Cryer Fig. 31 14mm
Cryer Fig. 32 14mm
SSI-B-296
Root Elevators Set of 2 Pcs
Cryer Fig. 44 10mm
Cryer Fig. 45 10mm



SSI-B-297
Root Elevators Set of 3 Pcs
Bein 3mm
Bein 4mm
Bein 5mm



SSI-B-298
Root Elevators Set of 3 Pcs
Coupland Bone Cheisl 3mm
Coupland Bone Cheisl 3.5mm
Coupland Bone Cheisl 4.5mm



SSI-B-299
Root Elevators Set of 3 Pcs
Chompret Fig. 1
Chompret Fig. 3
Chompret Fig. 4

Элеватор корневой экстракционный
Elévateurs à racines
Wurzelheber

Елеватор корневий екстракційний
Elevadores para raíces
المساعد الجذر



For Special Packing of Luxators Please Ask

SSI-B-310

Luxators (White Handle) Set of 10 Pcs

1.5mm Straight	1.5mm Curved
2mm Straight	2mm Curved
3mm Straight	3mm Curved
4mm Straight	4mm Curved
5mm Straight	5mm Curved



LUXATING ELEVATORS SET OF 10 PCS



■ Elevator корневой экстракционный ■ Elevator корневий экстракційний
■ Elévateurs à racines ■ Elevadores para raíces
■ Wurzelheber ■ المصاعد الجذر

For Special Packing of Luxators Please Ask



SSI-B-311
(Straight 1.5mm)

SSI-B-312
(Curved 1.5mm)

SSI-B-313
(Straight 2mm)

SSI-B-314
(Curved 2mm)

SSI-B-315
(Straight 3mm)

SSI-B-316
(Curved 3mm)

SSI-B-317
(Straight 4mm)

SSI-B-318
(Curved 4mm)

SSI-B-319
(Straight 5mm)

SSI-B-320
(Curved 5mm)



SSI-B-321
Luxators (Multi Handle) Set of 10 Pcs

- | | |
|----------------|--------------|
| 1.5mm Straight | 1.5mm Curved |
| 2mm Straight | 2mm Curved |
| 3mm Straight | 3mm Curved |
| 4mm Straight | 4mm Curved |
| 5mm Straight | 5mm Curved |



Элеватор корневой экстракционный
Elévateurs à racines
Wurzelheber

Елеватор корневий екстракційний
Elevadores para raíces
المصاعد الجذر

LUXATING ELEVATORS SET OF 10 PCS - BLUE TITANIUM COATED TIPS



For Special Packing of Luxators Please Ask



**SSI-B-332
Luxating Elevators Set of 10 Pcs -
Blue Titanium Coated Tips**

- | | |
|----------------|--------------|
| 1.5mm Straight | 1.5mm Curved |
| 2mm Straight | 2mm Curved |
| 3mm Straight | 3mm Curved |
| 4mm Straight | 4mm Curved |
| 5mm Straight | 5mm Curved |

- Элеватор корневой экстракционный
 ■ Elevator coronevii ekstraktsionnyy
- Elévateurs à racines
 ■ Elevadores para raíces
- Wurzelheber
 ■ المصاعد الجذر

SSI-B-333

LUXATING ELEVATORS SET OF 10 PCS - GOLD COATED TIPS

For Special Packing of Luxators Please Ask



SSI-B-344

LUXATING ELEVATORS SET OF 08 PCS - BLUE TITANIUM COATED TIPS



Элеватор корневой экстракционный
Elévateurs à racines
Wurzelheber

Слеватор корневий екстракційний
Elevadores para raíces
المصاعد الجذر

SSI-B-353

PERIOTOME LUXATING ELEVATORS SET OF 04 PCS - GOLD COATED TIPS



SSI-B-354
Periotome Gold Tip - L3S



SSI-B-355
Periotome Gold Tip - De3



SSI-B-356
Periotome Gold Tip - L2S



SSI-B-357
Periotome Gold Tip - L3CA



SSI-B-358 (Double Curved 1.5mm)
SSI-B-359 (Double Curved 2mm)
SSI-B-360 (Double Curved 3mm)
SSI-B-361 (Double Curved 4mm)
SSI-B-362 (Double Curved 5mm)



SSI-B-363
(Inverted Curved 3mm)



SSI-B-364
(Dual Edge 3mm / 1.5mm)



SSI-B-365
(Dual Edge 5mm / 3mm)

- Elevator корневой экстракционный
- Elévateurs à racines
- Wurzelheber
- Elevator корневий екстракційний
- Elevadores para raíces
- المصاعد الجذر

SSI-B-366

Titanium Plasma Coated PDL Elevators Set of 7 Pcs

- SSI-B-367**
Distal, 2.5mm
Micro Edge
- SSI-B-368**
Mesial, 2.5mm
Micro Edge
- SSI-B-369**
Distal, 4mm
Micro Edge
- SSI-B-370**
Mesial, 4mm
Micro Edge
- SSI-B-371**
2.5mm
Micro Edge, curved
- SSI-B-372**
2.5mm
Micro Edge, Straight
- SSI-B-373**
3.4mm
Straight



Area: distal



Area: mesial



SSI-B-374

Titanium Plasma Coated PDL Elevators Set of 7 Pcs
with Sterilisation Cassette

Элеватор корневой экстракционный
Elévateurs à racines
Wurzelheber

Елеватор корневий екстракційний
Elevadores para raices
المصاعد الجذر

SSI-B-375
PDL Elevators Set of 10 Pcs

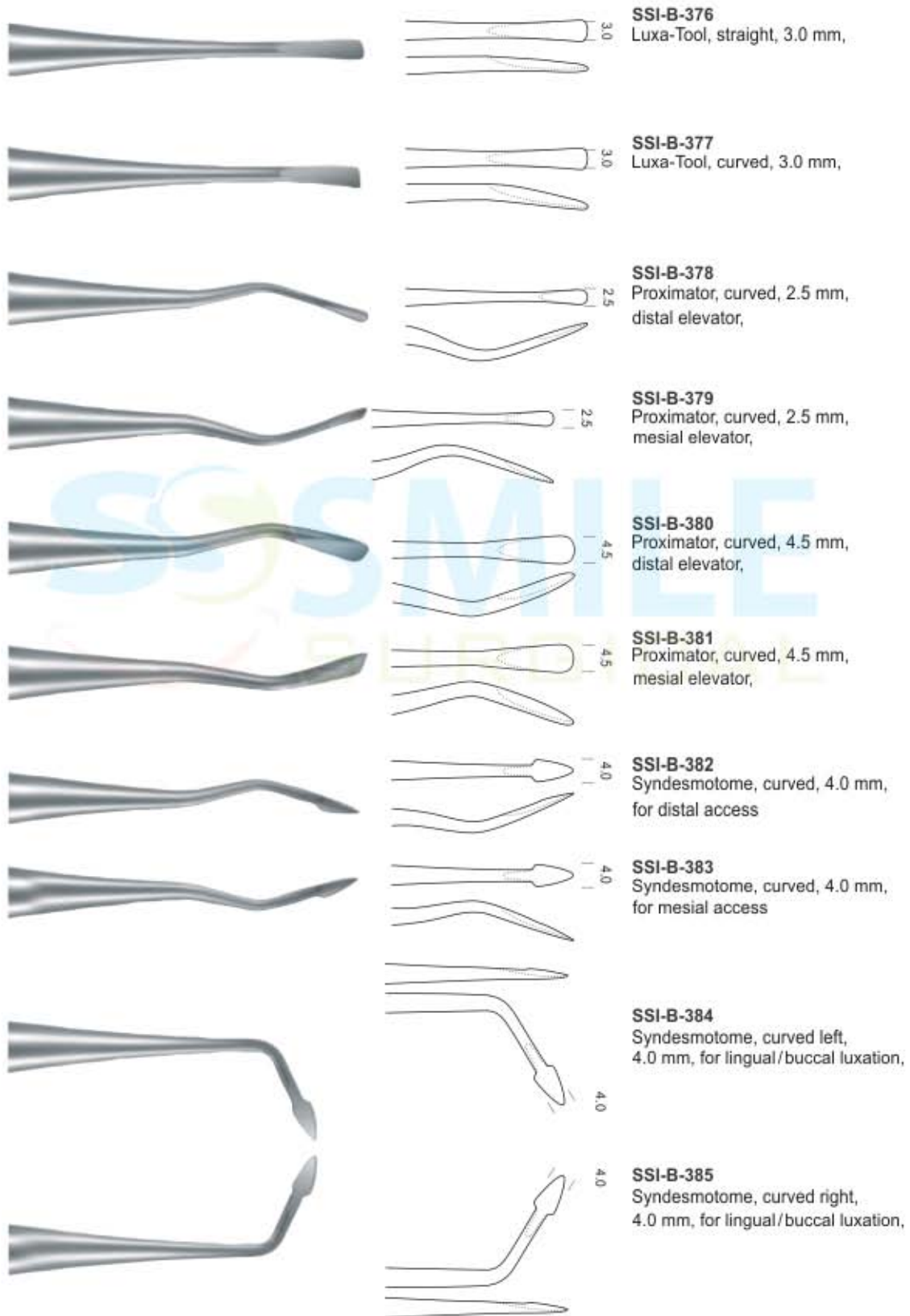

Элеватор корневой экстракционный
Elévateurs à racines
Wurzelheber

Слеватор корневий экстракційний
Elevadores para raices
المصاعد الجذر

PDL ELEVATORS

Delicate Arrow tip



SSI-B-387
4,0mm
straight

SSI-B-388
4,0mm
curved

Luxivators straight
atraumatic luxation of the tooth



SSI-B-389
2,5mm
straight

SSI-B-390
3,5mm
straight

SSI-B-391
4,5mm
straight

Luxivators curved
atraumatic luxation of the tooth



SSI-B-392
2,5mm
curved

SSI-B-393
3,5mm
curved

SSI-B-394
4,5mm
curved

SSI-B-395
PDL Elevators Set of 7 Pcs



Area: approximal (mesial, distal)



for loosening of the tooth



SSI-B-396
3.4mm
Straight

SSI-B-397
2.5mm Micro
Edge, Straight

SSI-B-398
2.5mm Micro
Edge, curved

SSI-B-399
Mesial, 2.5mm
Micro Edge

SSI-B-400
Distal, 2.5mm
Micro Edge

SSI-B-401
Mesial, 4mm
Micro Edge

SSI-B-402
Distal, 4mm
Micro Edge

SSI-B-386
PDL Elevators
Set of 8 Pcs

Dental Hand Instruments

The types of hand instruments can be categorized based on their function:

- Examining the mouth and teeth
- Scaling or professional cleaning of teeth
- Cutting teeth and removing cavities
- Placing and condensing filling materials
- Carving and finishing dental fillings
- Miscellaneous types
- Instruments used for examining the mouth and teeth

Mouth mirrors are used to examine the condition of the teeth and mouth, as well as to retract the tongue and cheeks upon examination.

Probes— There are many probes available but the main types are the straight probe, Briault probe and periodontal probe.

The straight probe is sharp and it is used to examine cavities in the dentine region as well as to check the margins of restorations or fillings.

The Briault probe is also sharp and it is used to detect the junction between the enamel and dentine. Briault can also be used to detect tartar hidden in the gum pockets.

A periodontal probe can be used to measure the depth of the gum pockets and for other measurements. Instruments for cutting and scraping tissues and deposits

Scalers remove tartar (calculus) on the tooth surface as well as those hidden in the gum pockets. They can also be used to remove other surface deposits and temporary crowns.

Excavators are used to remove softened dentine and temporary fillings. The back of the blade can also be used for placing linings between filling materials. Sometimes excavators can be used for carving metal or amalgam fillings.

Chisels are used to remove unsupported enamel during cavity preparation. Unsupported enamel can be harmful for it can compromise the longevity of the filling if not removed.

Hatchets and hoes have similar purposes to chisels. Instruments used for placing and condensing filling materials Plastic instruments convey and shape filling materials and are usually flat blades that do not use heavy pressure.

Some instruments have rounded ends for shaping and burnishing the surfaces of fillings. Plastic instruments are usually made of stainless steel for most materials though there are also thin Teflon-coated or titanium nitride instruments which are non-stick for composite fillings. **Condensers or pluggers** are used for compressing and forming filling materials. Heavy pressure is applied on use therefore these instruments are usually used for metal or amalgam fillings. Instruments used for carving and finishing fillings Carving and finishing instruments have sharp or semi-sharp blades of various shapes. They are used to carve materials by cutting and scraping.



Symptoms of Gum and Dental Problems



VALUED BUYERS

Compare our scalers and curettes with the best in the industry and you will immediately recognize we are equal in every way but one... price. Note the deep precision knurling for better tactile feel. The same high-grade stainless steel tips, the same light weight (under 20 grams) for less hand fatigue, the same professional craftsmanship, and surpassing the highest industry standards. Of course, any manufacturer can make these claims, but we guarantee and certify ours. We regularly manufacturing below articles in showing handles & pattern A to Y for better grip & perfection. We are also fully equipped & capable to develop these instruments as per your own specific requirements & demands in materials, sizes, shapes and patterns.



A-Hollow Handle Ø 10 mm



B-Hollow Handle Ø 10 mm



C-Hollow Handle Ø 10 mm



D-Hollow Handle Ø 10 mm



E-Hollow Handle Ø 10 mm



F-Hollow Handle Ø 10 mm



G-Hollow Handle Ø 10 mm



H-Hollow Handle Ø 6.4 mm



I-Hollow Handle Ø 8 mm



J-Hollow Handle Ø 10 mm



K-Soild Handle Ø 6 mm



L-Soild Handle Ø 6 mm



M-Hollow Handle Ø 10 mm



N-Hollow Handle Ø 10 mm



O-Hollow Handle Ø 10 mm



P-Hollow Handle Ø 10 mm



Q-Hollow Handle Ø 10 mm



R-Solid Handle Ø 6 mm



S-Solid Handle Ø 6 mm



T-Solid Handle Ø 6 mm



U-Hollow Handle Ø 8 mm



V-Hollow Handle Ø 8 mm



W-Silicon Handle



X-Autoclavable Handle Ø 11 mm



Y-Autoclavable Handle Ø 9.5 mm

зеркал
Espejos de la boca
Mundspiegel

дзеркал
Miroirs à la bouche
مرآة الفم



SSI-C-001
Set of 12 Pcs



SSI-C-006
Set of 12 Pcs

Plain

Cone-Socket Plain



SSI-C-002
Fig. 3
Ø20mm

SSI-C-003
Fig. 4
Ø22mm

SSI-C-004
Fig. 5
Ø24mm

SSI-C-005
Fig. 6
Ø26mm



SSI-C-007
Fig. 3
Ø20mm

SSI-C-008
Fig. 4
Ø22mm

SSI-C-009
Fig. 5
Ø24mm



SSI-C-010
Set of 12 Pcs



SSI-C-014
Set of 12 Pcs

Magnifying

Cone-Socket Magnifying



SSI-C-011
Fig. 3
Ø20 mm

SSI-C-012
Fig. 4
Ø22 mm

SSI-C-013
Fig. 5
Ø24 mm



SSI-C-015
Fig. 3
Ø20mm

SSI-C-016
Fig. 4
Ø22mm

SSI-C-017
Fig. 5
Ø24mm

■ зеркала
■ Espejos de la boca
■ Mundspiegel

■ дзеркала
■ Miroirs à la bouche
■ مرايا الفم



SSI-C-018
Set of 12 Pcs



SSI-C-022
Set of 12 Pcs



Rhodium



SSI-C-019
Fig. 3
Ø20mm

SSI-C-020
Fig. 4
Ø22mm

SSI-C-021
Fig. 5
Ø24 mm

Cone-Socket Rhodium



SSI-C-023
Fig. 3
Ø20mm

SSI-C-024
Fig. 4
Ø22mm

SSI-C-025
Fig. 5
Ø24mm



SSI-C-026
Set of 12 Pcs



SSI-C-031
Set of 12 Pcs

Front Surface



SSI-C-027
Fig. 3
Ø20mm

SSI-C-028
Fig. 4
Ø22mm

SSI-C-029
Fig. 5
Ø24mm

SSI-C-030
Fig. 6
Ø26mm



Cone-Socket Front Surface



SSI-C-032
Fig. 3
Ø20mm

SSI-C-033
Fig. 4
Ø22mm

SSI-C-034
Fig. 5
Ø24mm

■ Ручки для зеркал
■ Manches pour miroirs à bouche
■ Mundspiegelgriffe

■ Ручки для дзеркал
■ Mangos para espejos de boca
■ مقابض لمرآة الفم



SSI-C-035
Hollow Mirror Handle Round Ø 10 mm



SSI-C-036
Hollow Mirror Handle Hexagonal Ø 8 mm



SSI-C-037
Hollow Mirror Handle Hexagonal Ø 8 mm



SSI-C-038
Hollow Mirror Handle Hexagonal Ø 10 mm



SSI-C-039
Hollow Mirror Handle Hexagonal Ø 8 mm



SSI-C-040
Hollow Mirror Handle Hexagonal Ø 10 mm



SSI-C-040A
Hollow Mirror Handle Hexagonal Ø 8 mm



SSI-C-040B
Mirror Handle Autoclavable Material Available in Various Colours Ø 9.5 mm



SSI-C-040C
Mirror Handle Autoclavable Material Available in Various Colours Ø 9.5 mm



SSI-C-040D
Mirror Handle Silicon Grip Autoclavable Available in Various Colours



SSI-C-041
Mirror Handle Solid Ø 6 mm



SSI-C-042
Mirror Handle Solid Ø 6 mm



SSI-C-043
Mirror Handle Solid Octagonal Ø 6 mm



SSI-C-044
Mirror Handle Solid Stem with Rule 35mm



SSI-C-045
Cone-Socket Solid Octagonal Ø 6 mm



SSI-C-046
Cone-socket Solid Ø 6 mm



SSI-C-047
Cone-socket Hexagonal Handle Ø 6 mm

Cone-Socket Mirror Handle

TWEEZERS

■ Пинцеты
■ Précelles - Bruxelles
■ Zahnpinzetten

■ Пинцети
■ Pinzas para algodón
■ ملاقط



SSI-C-048
London College
150mm



SSI-C-049
Meriam
160mm



SSI-C-050
Semken Taylor
125mm
Straight



SSI-C-051
Semken Taylor
125mm
Curved



SSI-C-052
Semken Taylor
125mm
1x2 Straight



SSI-C-053
Semken Taylor
125mm
1x2 Curved



SSI-C-054
Flagg
150mm



SSI-C-055
Meriam
160mm



SSI-C-056
Amsterdam
155mm



SSI-C-057
Perry
130mm
Curved



SSI-C-058
Self-Locking
150mm
Angled



SSI-C-059
Endo-Locking
Grooved
150mm

TWEEZERS

■ Пинцеты
■ Précelles - Brucelles
■ Zahnpinzetten

■ Пинцети
■ Pinzas para algodón
■ ملاقط



SSI-C-060 90mm
SSI-C-061 120mm
SSI-C-062 150mm
SSI-C-063 180mm
 Taylor



1x2
 ø mm 0,9
SSI-C-064 90mm
SSI-C-065 120mm
SSI-C-066 150mm
SSI-C-067 180mm
 Taylor



1x2
 ø mm 0,9
 ø mm 0,6
SSI-C-068 0,6mm
SSI-C-069 0,9mm
 Gerald
 175mm



1x2
 ø mm 0,9
 ø mm 0,6
SSI-C-070 0,6mm
SSI-C-071 0,9mm
 Gerald
 175mm



SSI-C-072
 Gerald
 175mm



SSI-C-073
 Gerald
 175mm



SSI-C-074
 150mm
 College



SSI-C-075
 Meriam
 150mm



SSI-C-076
 De Backy
 Atraumatic
 150mm
 Straight



SSI-C-077
 De Backy
 Atraumatic
 150mm
 Angled





SSI-C-078
 De Backy
 Atraumatic
 175mm



SSI-C-079
 Gilles
 150mm 1x2

TWEEZERS

 Пинцеты
 Précelles - Bruxelles
 Zahnpinzetten

 Пінцети
 Pinzas para algodón
 ملاقط



SSI-C-080
Meriam Tweezers
smooth 16cm



SSI-C-081
London College
smooth 16cm



Adson With Teeth
SSI-C-082 12cm
SSI-C-083 15cm



SSI-C-084
Perry
10.5 cm



SSI-C-085
Perry
10.5 cm



SSI-C-086
Fig. 1
Perry
13 cm



Potts-Smith Dressing Forceps
SSI-C-087 18 cm
SSI-C-088 20 cm
SSI-C-089 25 cm
straight serrated



Potts-Smith Dressing Forceps
SSI-C-090 18 cm
SSI-C-091 20 cm
SSI-C-092 25 cm
curved serrated



Potts-Smith Tissue Forceps 1x2 teeth
SSI-C-093 18 cm
SSI-C-094 20 cm
SSI-C-095 25 cm
straight



Potts-Smith Tissue Forceps 1x2 teeth
SSI-C-096 18 cm
SSI-C-097 20 cm
SSI-C-098 25 cm
curved



De-Bakey With Tungsten Carbide (TC) 17.5cm
SSI-C-099



Cushing Taylor 18cm
SSI-C-100



TWEEZERS

■ Пинцеты
■ Précettes - Brucelles
■ Zahnpinzetten

■ Пинцети
■ Pinzas para algodón
■ ملاقط



SSI-C-101
Adson-TC
120mm



SSI-C-102
Adson-TC
120mm 1x2



SSI-C-103
Adson-TC
150mm 1x2



SSI-C-104
Adson
120mm



SSI-C-105
Adson
120mm 1x2



SSI-C-106
Adson
150mm 1x2



SSI-C-107
Adson Brown
120mm



SSI-C-108
Crane Kaplan
150mm



SSI-C-109 115mm
SSI-C-110 140mm
Dressing Forceps



SSI-C-111 115mm
SSI-C-112 140mm
Tissue Forceps



SSI-C-113
Hemingway
150mm



SSI-C-114
Crane Kaplan
150mm





SSI-C-115
Crane Kaplan
150mm



SSI-C-116
Gerald
175mm

 Пинцеты
 Précelles - Bruxelles
 Zahnpinzetten

 Пінцети
 Pinzas para algodón
 ملاقط



Adson-Brown

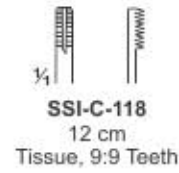

Adson-Brown



Brown



Ewald / Hudson



Adson /
Micro-Adson



Adson
T.C

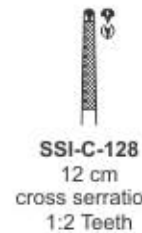

TWEEZERS

■ Пинцеты
■ Précelles - Brucelles
■ Zahnpinzetten

■ Пинцети
■ Pinzas para algodón
■ ملاقط



SSI-C-130
Adson
1 mm
12 cm



SSI-C-131
Adson T.C
1,7 mm
12 cm



SSI-C-132
Adson
1,7 mm
15 cm



SSI-C-133
Micro-Adson
very fine
0,8 mm
15 cm



SSI-C-134
Adson
1x2, 1,5 mm
12 cm



SSI-C-135
Micro-Adson
1x2, 1 mm
15 cm
very fine



SSI-C-136
Micro-Adson
1x2, 1 mm
15 cm
curved
very fine



SSI-C-137
Cushing
1,2 mm
18 cm



SSI-C-138 13 cm
1x2, 1,5 mm
SSI-C-139 14 cm
1x2, 1,7 mm



SSI-C-140
Taylor
1x2, 1,5 mm
17,5 cm



SSI-C-141 13 cm
1x2, 2,3 mm
SSI-C-142 14 cm
1x2, 2,3 mm



SSI-C-143
Micro-Cushing
1x2, 0,9 mm
17,5 cm
very fine



SSI-C-144
Suture Forceps
15 cm

■ Пинцеты
■ Précèlles - Brucelles
■ Zahnpinzetten

■ Пинцети
■ Pinzas para algodón
■ ملاقط



SSI-C-145
15 cm
Fig. 1
Thin Pattern



SSI-C-146
15 cm
Fig. 2
Wide Pattern



SSI-C-147
16 cm



SSI-C-148
15 cm
Fig. 1



SSI-C-149
15 cm
Fig. 2



SSI-C-150
11.5 cm
Fig. 1

Micro Surgery Instrument



SSI-C-151
18 cm
Fig. 1



SSI-C-152
18 cm
Fig. 2



SSI-C-153
18 cm
Fig. 3



SSI-C-154
18 cm
Fig. 4

SOLDERING PLIERS - TWEEZERS & SPLINTER FORCEPS

■ Пинцеты для удаления осколков
■ Pincés à souder - Pincés et pincés à échardes
■ Löt-Zange - Pinzette & SplinterZange

■ Пинцети для видалення осколків
■ Alicates Soldadura - Pinzas y pinzas de Splinter
■ لحام كمشافة - ملاقط منشقة الملائط



SSI-C-155
Soldering Pliers
160mm



SSI-C-156
Soldering Pliers
160mm



SSI-C-157
Posigrip Articulating
Paper Forceps
150mm



SSI-C-158
Standard Articulating
Paper Forceps, Economy Grade
150mm



SSI-C-159
Miller
150mm
Curved



SSI-C-160
125mm



SSI-C-161
125mm



SSI-C-162
115mm



SSI-C-163
125mm



SSI-C-164
125mm



SSI-C-165
Peet
115mm

Комплект для обследования
Ensemble d'examen
Prüfungssatz

Екзаменаційний набір
Conjunto de examen
مجموعة الفحص

SSI-C-166

First Aid Examination kit Set of 3 Pieces



SSI-C-167

First Aid Examination Set of 4 Pieces



SSI-C-168

First Aid Examination Set of 3 Pieces



SSI-C-169

First Aid Examination Set of 3 Pieces



SSI-C-170

First Aid Examination Set of 3 Pieces



SSI-C-171

First Aid Examination Set of 3 Pieces



■ Комплект для обследования
■ Ensemble d'examen
■ Prüfungssatz

■ Экзаменаційний набір
■ Conjunto de examen
■ مجموعة الفحص

SSI-C-171A

First Aid Examination kit Set of 3 Pieces



SSI-C-171B

First Aid Examination Set of 4 Pieces



SSI-C-171C

First Aid Examination Set of 3 Pieces



SSI-C-171D

First Aid Examination Set of 3 Pieces



SSI-C-171E

First Aid Examination Set of 3 Pieces



SSI-C-171F

First Aid Examination Set of 3 Pieces



■ Зонды
■ Sondes
■ Zahnsonden
■ Зонди
■ Sondas
■ المستكشفين

Single Ended Probe Solid Handle Ø 6 mm, Length 150mm



Single Ended Probe Hollow Handle Ø 8 mm Length 150mm

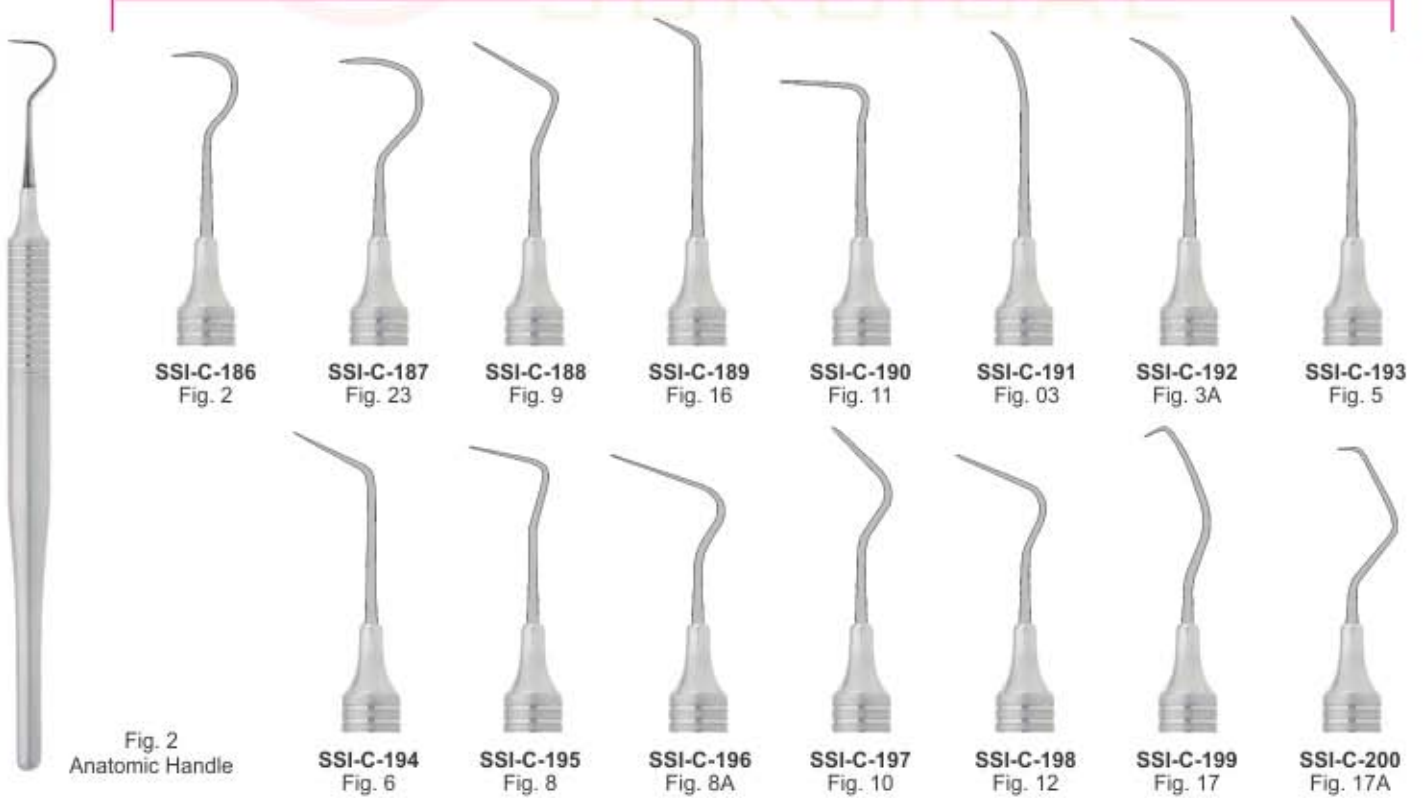

Зонды
Sondes
Zahnsonden

Зонди
Sondas
المستكشفين

EXPLORERS INSTRUMENTS AVAILABLE IN
Hollow Handle Ø 8 mm, Ø 10mm Solid Handle Ø 6mm
Length 170MM



Зонд
Sonde
Sonde

Зонд
Sonda
مستبان

Available in Hollow Handle
Ø 8 mm, Ø 10mm Solid Handle Ø 6mm

3-6-9-12

1-2-3-5-7-8-9-10
FLAT

1-2-3-5-7-8-9-10

3-6-9-12



12-9-6-3

SSI-C-208

UT3/4
Cattoni

10-9-8-7-5-3-2-1
FLAT

SSI-C-209

3N
Nabers

10-9-8-7-5-3-2-1

SSI-C-210

Williams DE
Offset

10-9-8-7-5-3-2-1

SSI-C-211

CP-12/Thin
Williams

SSI-C-212

1N
Nabers

SSI-C-213

2N
Nabers

Зонды
Sondes
Zahnsonden

Зонди
Sondas
المستكشفين

Explorers Instruments Available in Hollow Handle Ø 8 mm, Ø 10 mm Solid Handle Ø 6 mm



Probes Double Ended

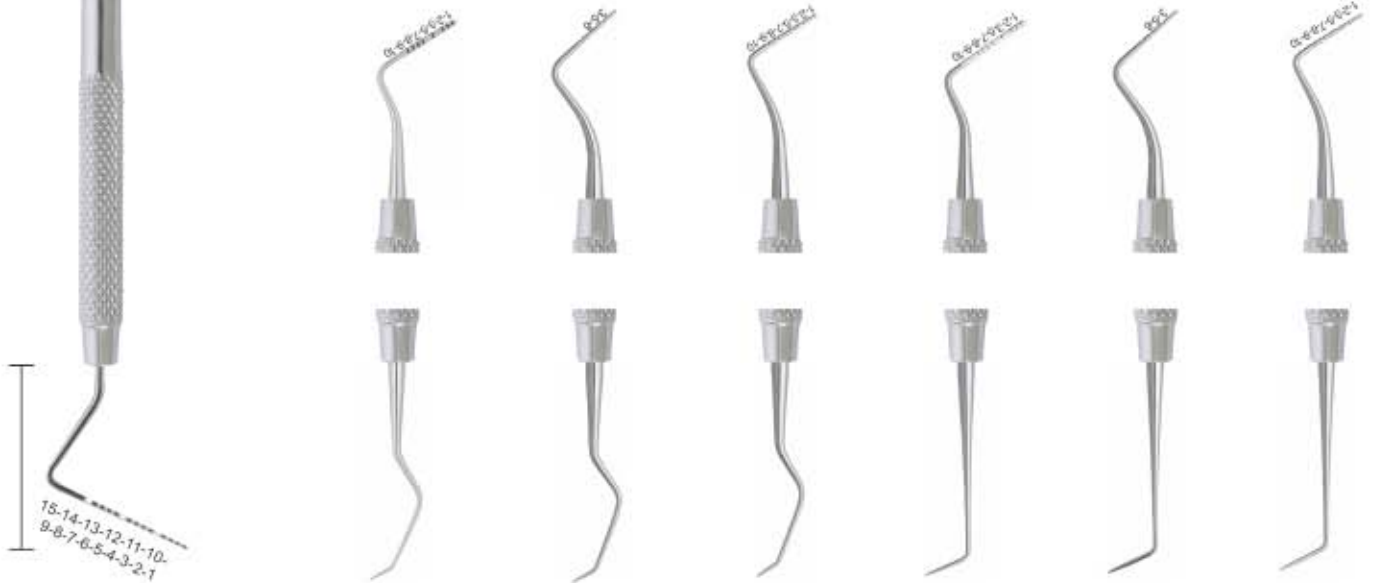

SSI-C-218
23/UNC1
university of north carolina

SSI-C-219
Goldman Fox
Fig. 17

SSI-C-220
University of Michigan
Fig. 17

SSI-C-221
Williams
Fig. 17

SSI-C-222
Goldman Fox
Fig. 16

SSI-C-223
University of Michigan
Fig. 16

SSI-C-224
Williams
Fig. 16

PREMIUM QUALITY DENTAL INSTRUMENTS

Зонды
Sondes
Zahnsonden

Зонди
Sondas
المستكشفين

Pointed Probes Available in Hollow Handle Ø 8 mm, Ø 10 mm Solid Handle Ø 6 mm



Pointed Probes Available in Hollow Handle Ø 8 mm, Ø 10 mm Solid Handle Ø 6 mm



Инструменты пародонтологические
Instruments pour la parodontologie
Instrumente für die Parodontologie

Инструменти пародонтологічні
instrumentos para periodoncia
الصكوك اللثة

SSI-C-237

Periodontal Set of 10 Pieces Available in Hollow Handle Ø 8 mm, Ø 10 mm Solid Handle Ø 6 mm



SSI-C-238
Mouth Mirror

SSI-C-239
EXP,23/17-A

SSI-C-240
Excavators

SSI-C-241
Filling
Instruments

SSI-C-242
EXP,23/CP-18

SSI-C-243
EXP,23/CP-QW

SSI-C-244
EXP,23/CP-11

SSI-C-245
EXP,23/CP-10

SSI-C-246
EXP,23/CP-12

SSI-C-247
EXP,23/CP-11.5-B

■ Инструменты пародонтологические
■ Instruments pour la parodontologie
■ Instrumente für die Parodontologie

■ Інструменти пародонтологічні
■ instrumentos para periodoncia
■ الصكوك اللثة

Available in Hollow Handle Ø 8 mm, Ø 10 mm Solid Handle Ø 6 mm

SSI-C-248
Columbia Set

SSI-C-252
McCall Set

Columbia 2L/2R



SSI-C-249

Columbia 4L/4R



SSI-C-250

Columbia 13/14



SSI-C-251

McCalls 14S/18S



SSI-C-253

McCalls 17/18



SSI-C-254

McCalls 13S/14S



SSI-C-255

McCalls 13/14



SSI-C-256

Зонды
Sondes
Zahnsonden

Зонди
Sondas
المستكشفين

SSI-C-257

William Probe Set Double Ended With Hollow Handle Ø 10 Mm, Length 170mm
Plasma Coated Handle

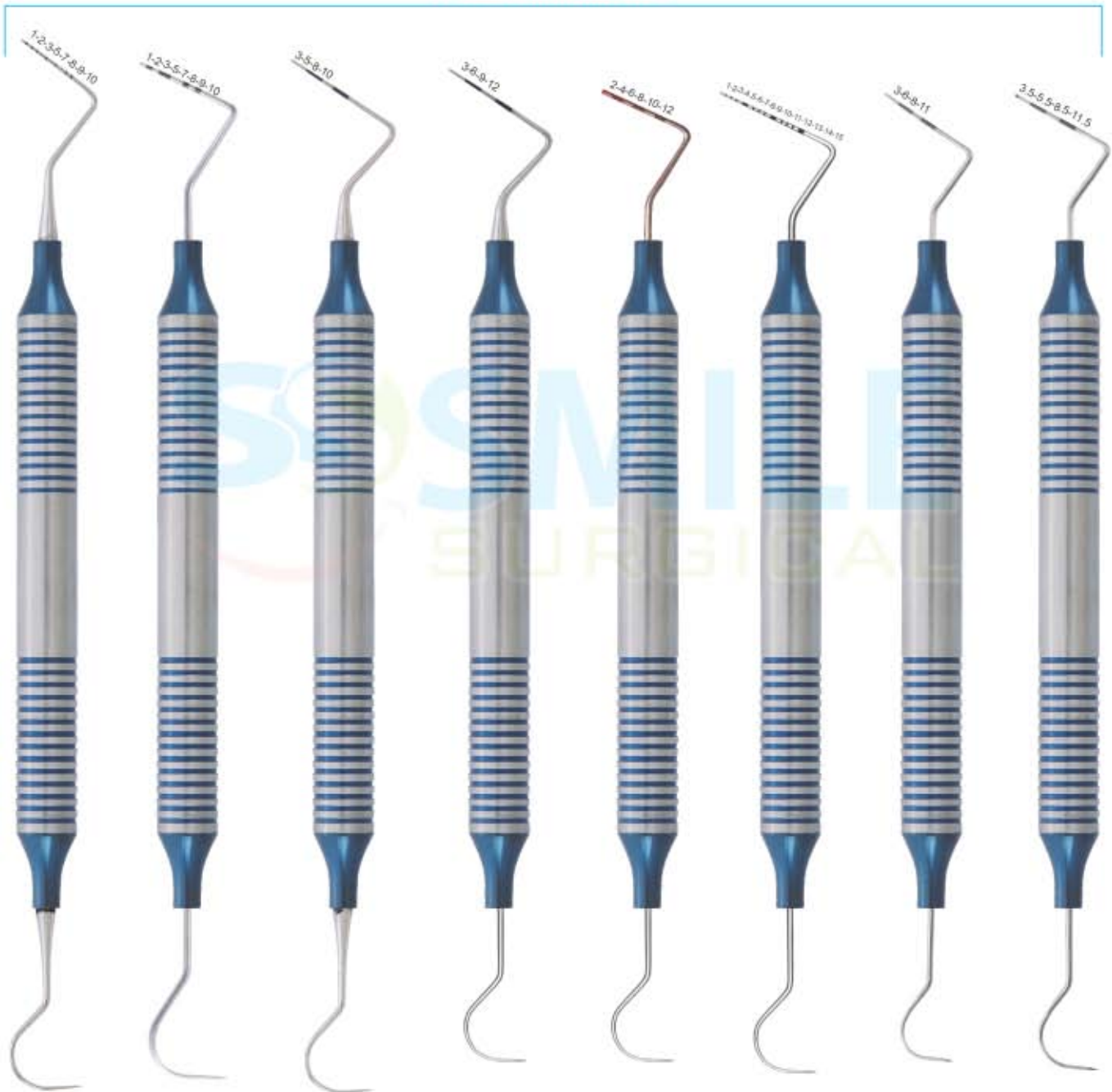

SSI-C-258
EXP, 23/CO,QW

SSI-C-259
EXP, 23/CP,10

SSI-C-260
EXP, 23/CP,18

SSI-C-261
EXP, 23/CP,12

SSI-C-262
EXP, 23/CP,2

SSI-C-263
EXP, 23/UNC,15

SSI-C-264
EXP, 23/CP,11

SSI-C-265
EXP, 23/CP, 12 ,S

- Зонды
- Sondes
- Zahnsonden
- Зонди
- Sondas
- المستكشفين

Explorers Instruments Available in Hollow Handle Ø 8 mm, Ø 10 mm Solid Handle Ø 6 mm

PLUGGERS

Tip Size: 1/1
Solid Handle Size 4.25"

Tip Size: .40

Solid Handle Size 4.25"

Tip Size: .50
SSI-C-267
5/7
21mm

Tip Size: 1.00
SSI-C-268
9/11
21mm

Tip Size: .50
SSI-C-269
1/2
Root Canal
Plugger

Tip Size: .80
SSI-C-270
3/4
Root Canal
Plugger

Tip Size: .75

Tip Size: 1.15

Tip Size: .60

Tip Size: 1.10

Tip Size: .45
SSI-C-266
1/3
21mm

Tip Size: .20
SSI-C-271
MA57
27mm

Tip Size: .25
SSI-C-272
GP3
30mm

Tip Size: .30
SSI-C-273
ISO
Size 30
24mm

Tip Size: .40
SSI-C-274
ISO
Size 40
24mm

Tip Size: .50
SSI-C-275
ISO
Size 50
24mm

Tip Size: .60
SSI-C-276
ISO
Size 60
24mm

Зонды пародонтологические
 Sondes parodontales
 sonda parodontali

зонди пародонтологічні
 Sondas parodontales
 المسابر اللثة

Available in Hollow Handle Ø 8 mm, Ø 10 mm Solid Handle Ø 6 mm

SPREADERS

HEAT CARRIERS

Tip Size: 1/1

Solid Handle Size 4.25"

Instrument	Tip Size	ISO / Standard	Length
SSI-C-278	.30	ISO Size 40	24mm
SSI-C-279	.40	ISO Size 50	28mm
SSI-C-280	.60	ISO Size 60	28mm
SSI-C-281	.25	GP1	20mm
SSI-C-282	.30	1S Wakai	22mm
SSI-C-283	.40	2S Wakai	22mm
SSI-C-284	.40	D11 Standard	23mm
SSI-C-285	.35	D11S Thin	23mm
SSI-C-277	-	ISO Size 30	24mm
SSI-C-286	.23	D11T Thinner	22mm
SSI-C-287	.20	D11TS Thinnest	21mm
SSI-C-288	.35	3	28mm
SSI-C-289	.25	GP2	25mm
SSI-C-290	.35	0‡	25mm
SSI-C-291	.55	00‡	25mm

HEAT CARRIERS

Зонды пародонтологические
Sondes paradontales
sonde parodontali

зонди пародонтологічні
Sondas paradontales
المساطر اللثة

Endodontics Instruments Available in Hollow Handle Ø 8 mm, Ø 10 mm Solid Handle Ø 6 mm

ANTERIOR SINGLE ENDED



Зонды пародонтологические
 Sondes parodontales
 sonda parodontali

зонди пародонтологічні
 Sondas parodontales
 المسابر اللثة

Endodontics Instruments Available in Hollow Handle Ø 8 mm, Ø 10 mm Solid Handle Ø 6 mm
 POSTERIOR SINGLE ENDED



RETRO FILLING PLUGGERS

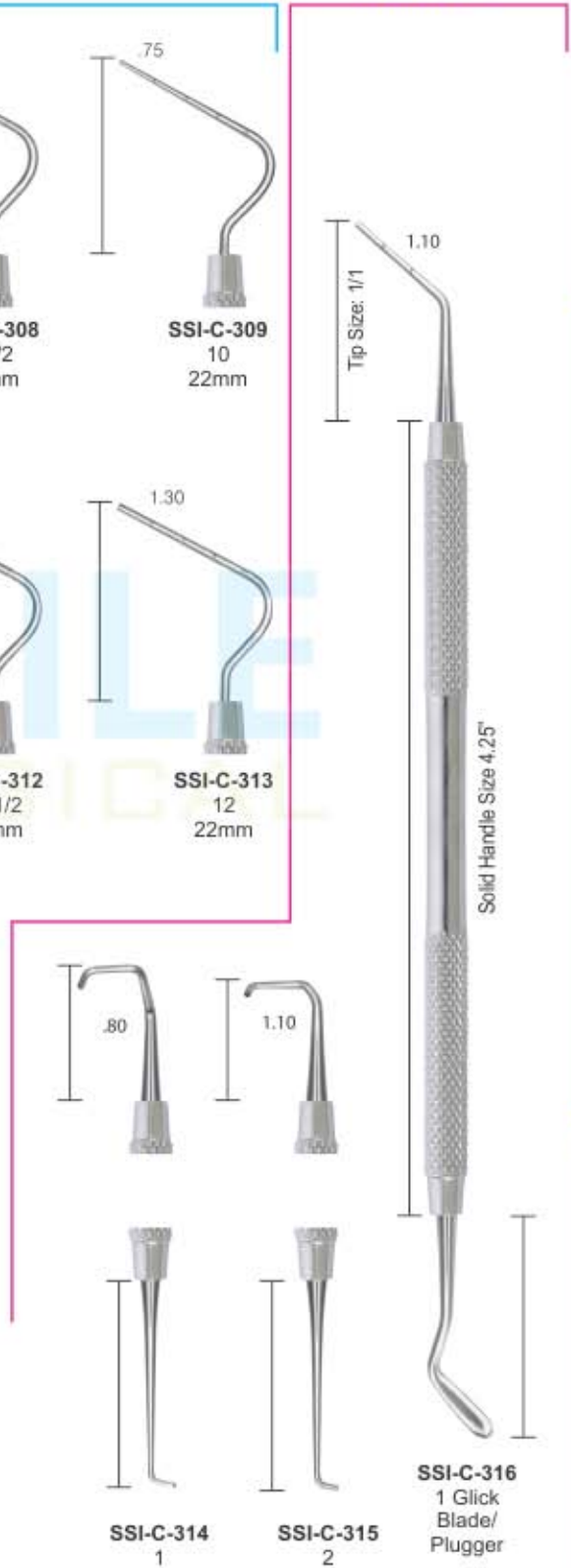

PREMIUM QUALITY DENTAL INSTRUMENTS

- Инструменты для реставрации
- Инструменти для реставрації
- Instruments pour plombage
- Instrumentos para obturaciones
- Füllungsinstrumente (mit Kontrawinkel)
- ملء الصنوك

Amalgam and Plastic Filling Instruments Available in Hollow Handle Ø 8 mm, Ø 10 mm Solid Handle Ø 6 mm



PREMIUM QUALITY DENTAL INSTRUMENTS

■ Инструменты для реставрации
■ Instruments pour plombage
■ Füllungsinstrumente (mit Kontrawinkel)

■ Інструменти для реставрації
■ Instrumentos para obturaciones
■ ملء الصنوك

Amalgam and Plastic Filling Instruments Available in Hollow Handle Ø 8 mm, Ø 10 mm Solid Handle Ø 6 mm



Инструменты для реставрации
Instruments pour plombage
Füllungsinstrumente (mit Kontrawinkel)

Инструменти для реставрації
Instrumentos para obturaciones
ملء الصكوك

Amalgam and Plastic Filling Instruments Available in Hollow Handle Ø 8 mm, Ø 10 mm Solid Handle Ø 6 mm



■ Инструменты для реставрации ■ Инструменти для реставрації
■ Instruments pour plombage ■ Instrumentos para obturaciones
■ Füllungsinstrumente (mit Kontrawinkel) ■ ملء الصكوك

Amalgam Instruments and Burnishers Available in Hollow Handle Ø 8 mm, Ø 10 mm Solid Handle Ø 6 mm



- Инструменты для реставрации
- Instruments pour plombage
- Füllungsinstrumente (mit Kontrawinkel)
- Инструменти для реставрації
- Instrumentos para obturaciones
- ملء الصكوك

Amalgam Instruments and Burnishers Available in Hollow Handle Ø 8 mm, Ø 10 mm Solid Handle Ø 6 mm



PREMIUM QUALITY DENTAL INSTRUMENTS

- Инструменты для реставрации
- Instruments pour plombage
- Füllungsinstrumente (mit Kontrawinkel)
- Инструменти для реставрації
- Instrumentos para obturaciones
- ملء الصكوك

Plastic Filling Instruments Available in Hollow Handle Ø 8 mm, Ø 10 mm Solid Handle Ø 6 mm



Инструменты для реставрации

Instruments pour plombage

Füllungsinstrumente (mit Kontrawinkel)

Инструменти для реставрації

Instrumentos para obturaciones

ملء الصكوك

Plastic Filling Instruments Available in Hollow Handle Ø 8 mm, Ø 10 mm Solid Handle Ø 6 mm

PREMIUM QUALITY DENTAL INSTRUMENTS



Инструменты для реставрации
Instruments pour plombage
Füllungsinstrumente (mit Kontrawinkel)

Инструменти для реставрації
Instrumentos para obturaciones
ملء الصكوك

Composite Gold Coated Instruments



SSI-C-387
Markley 2



SSI-C-388
Westcott N.21



SSI-C-389
NYU/B2



SSI-C-390
Filling instruments



SSI-C-391
Ball Filling Instruments

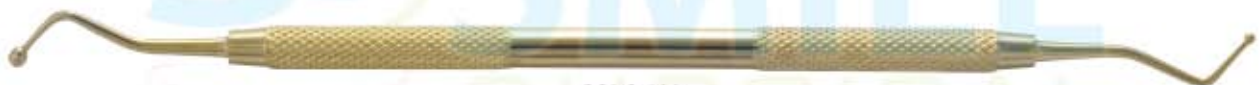

SSI-C-392
Filling Instruments



SSI-C-393
Filling Instruments



SSI-C-394
Filling Instruments



SSI-C-395
Plastic Filling Instruments



SSI-C-396
Heidemann



SSI-C-397
Plastic Filling Instruments

Инструменты для реставрации

Instruments pour plombage

Füllungsinstrumente (mit Kontrawinkel)

Инструменти для реставрації

Instrumentos para obturaciones

ملء المستوك

Composite Gold Tip Instruments



SSI-C-398
Markley 2

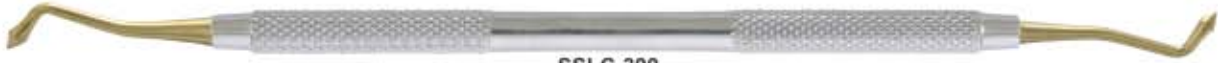

SSI-C-399
Westcott N.21



SSI-C-400
NYU/B2



SSI-C-401
Filling instruments

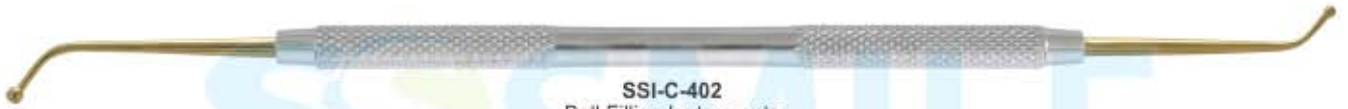

SSI-C-402
Ball Filling Instruments



SSI-C-403
Filling Instruments



SSI-C-404
Filling Instruments



SSI-C-405
Filling Instruments



SSI-C-406
Plastic Filling Instruments



SSI-C-407
Heidemann



SSI-C-408
Plastic Filling Instruments

Инструменты пародонтологические
Instruments pour la parodontologie
Instrumente für die Parodontologie

Інструменти пародонтологічні
intrumentos para periodoncia
الصكوك اللثة

Heidemann Spatula

Available in Hollow Handle Ø 8 mm, Ø 10 mm Solid Handle Ø 6 mm

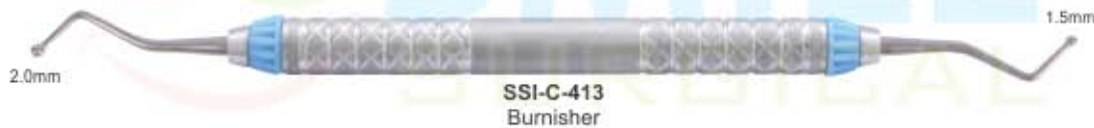

Инструменты пародонтологические
Instruments pour la parodontologie
Instrumente für die Parodontologie

Инструменти пародонтологічні
instrumentos para periodoncia
الصكوك اللثة

Excavators

Excavators Instruments

Available in Hollow Handle Ø 8 mm, Ø 10 mm Solid Handle Ø 6 mm



SSI-C-418



SSI-C-419
Fig. 3



SSI-C-420
Fig. 4



SSI-C-421
Exc # 14



SSI-C-422
Exc # 17



SSI-C-423
Exc # 18



SSI-C-424
Exc # 19



SSI-C-425
Exc # 22

Инструменты пародонтологические
Instruments pour la parodontologie
Instrumente für die Parodontologie

Инструменти пародонтологічні
intrumentos para periodoncia
الصكوك اللثة

Composite Instruments

Available in Hollow Handle Ø 8 mm, Ø 10 mm Solid Handle Ø 6 mm

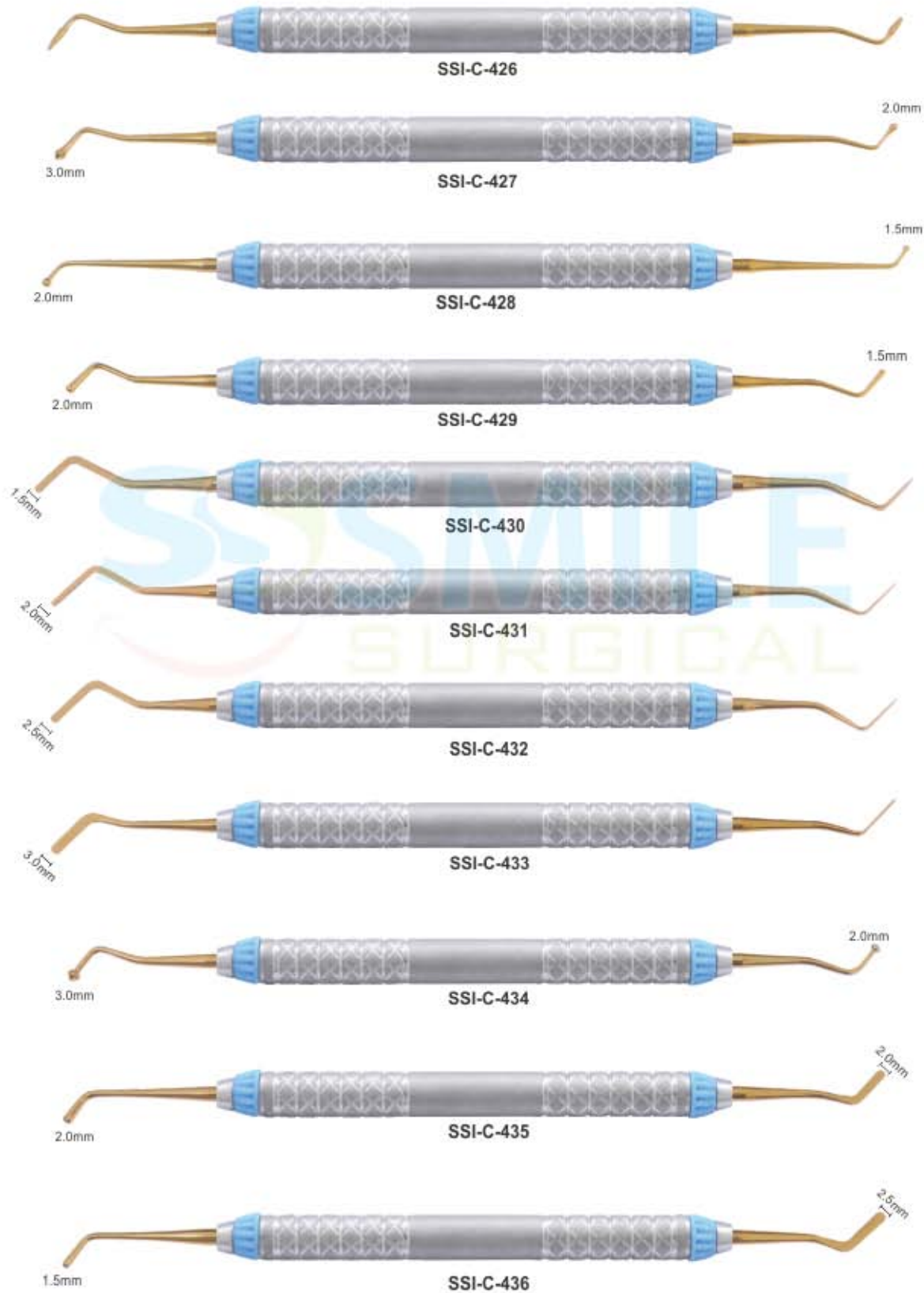

Инструменты пародонтологические
Instruments pour la parodontologie
Instrumente für die Parodontologie

Инструменти пародонтологічні
instrumentos para periodoncia
الصكوك اللثة

Crane Kaplan

Available in Hollow Handle Ø 8 mm



SSI-C-437



SSI-C-438
Jaquette



SSI-C-439
Columbia 13/14



SSI-C-440
Kirkland 15/16



SSI-C-441
Goldman Fox



SSI-C-442
Gracey 11/12



SSI-C-443
Gracey 13/14



SSI-C-444
Columbia 2R/2L



SSI-C-445
Orban Knife 1/2

Lucas Currettes

Available in Hollow Handle Ø 8 mm



SSI-C-446
Ø 2 mm



SSI-C-447



SSI-C-448
Ø 2.5 mm

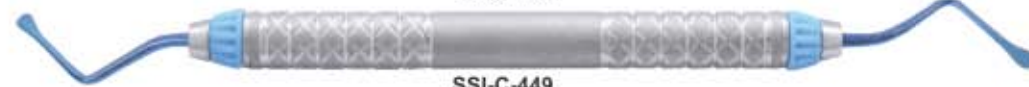

SSI-C-449
Ø 3 mm

Инструменты пародонтологические
Instruments pour la parodontologie
Instrumente für die Parodontologie

Інструменти пародонтологічні
instrumentos para periodoncia
الصكوك اللثة

Sinus Lift Instruments Blue Plasma Coating

Available in Hollow Handle Ø 8 mm, Ø 10 mm Solid Handle Ø 6 mm



SSI-C-450
Fig. 1



SSI-C-451
Fig. 2



SSI-C-452
Fig. 3



SSI-C-453
Fig. 4



SSI-C-454
Fig. 5



SSI-C-455
Fig. 6



SSI-C-456
Fig. 7



SSI-C-457
Fig. 8

Gingival Retractors

Available in Hollow Handle Ø 8 mm, Ø 10 mm Solid Handle Ø 6 mm



SSI-C-458



SSI-C-459



SSI-C-460

Инструменты пародонтологические
Instruments pour la parodontologie
Instrumente für die Parodontologie

Инструменти пародонтологічні
instrumentos para periodoncia
الصكوك النثة

Blue Plasma Coating & Operative instruments
Available in Hollow Handle Ø 8 mm

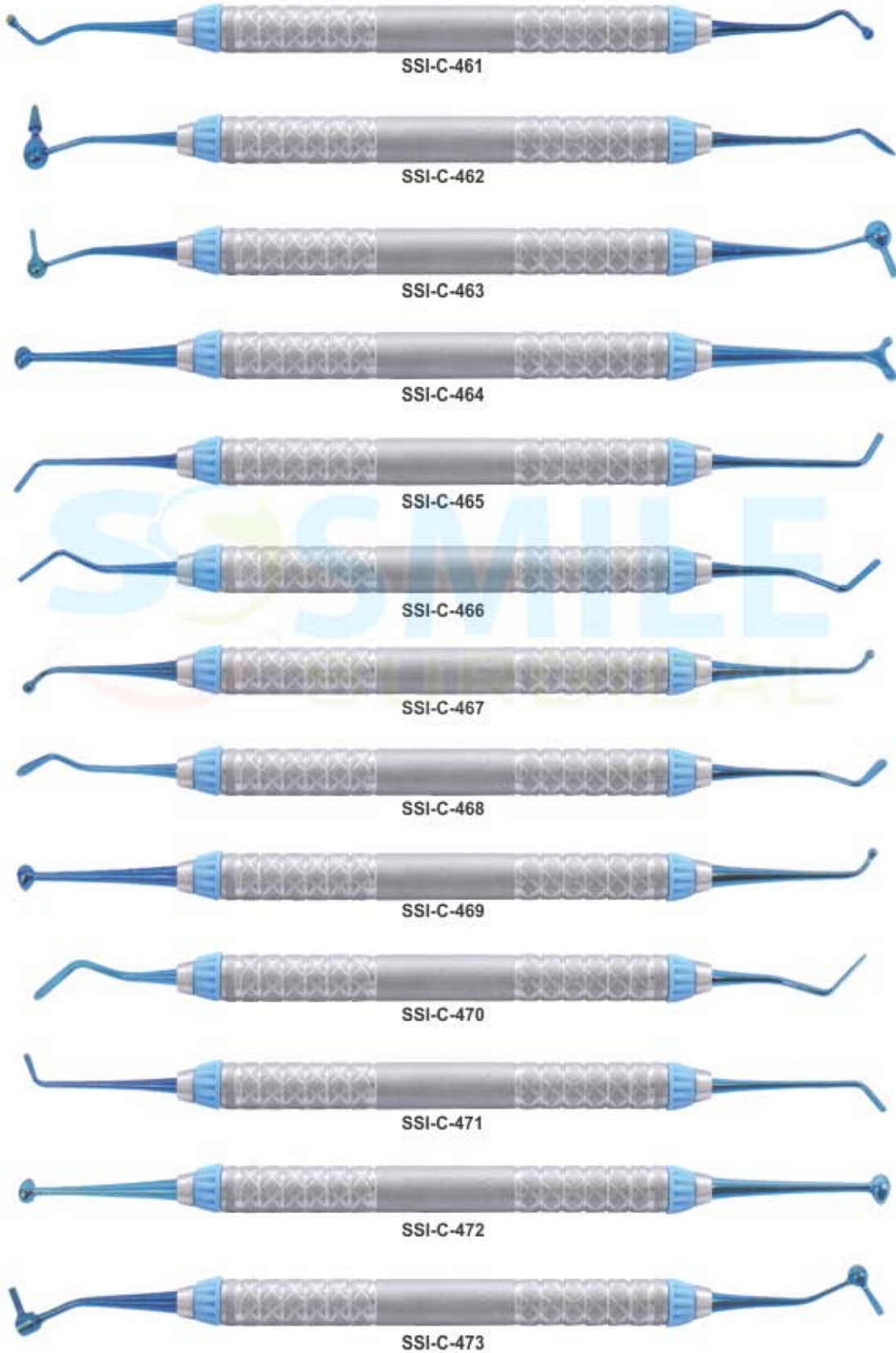

Инструменты для реставрации
Instruments pour plombage
Füllungsinstrumente (mit Kontrawinkel)

Инструменти для реставрації
Instrumentos para obturaciones
ملء الصنوك

CARVERS INSTRUMENTS

Available in Hollow Handle Ø 8 mm, Ø 10 mm Solid Handle Ø 6 mm



Инструменты для реставрации
Instruments pour plombage
Füllungsinstrumente (mit Kontrawinkel)

Инструменти для реставрації
Instrumentos para obturaciones
ملء الصنوك

CARVERS INSTRUMENTS

Available in Hollow Handle Ø 8 mm, Ø 10 mm Solid Handle Ø 6 mm



SSI-C-482
1
3-SHO



SSI-C-483
3
SHO-A



SSI-C-484
8
Wiland 8



SSI-C-485
SPR18

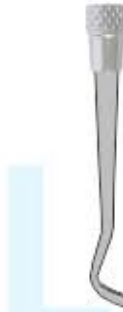

SSI-C-486
1
Frahm 0/1

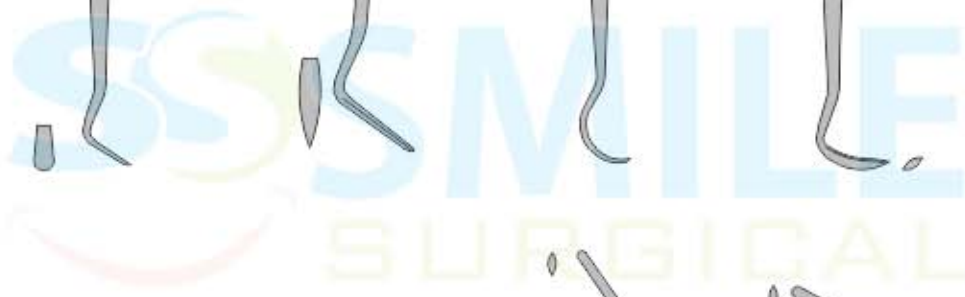

SSI-C-487
Frahm 2/3



SSI-C-488
1
Interproximal 1
IPC1



SSI-C-489
2
Interproximal
Off-Angle



SSI-C-490
1
Mercury



■ Инструменты для реставрации ■ Инструменти для реставрації
■ Instruments pour plombage ■ Instrumentos para obturaciones
■ Füllungsinstrumente (mit Kontrawinkel) ■ ملء الصكوك

CARVERS INSTRUMENTS

Available in Hollow Handle Ø 8 mm, Ø 10 mm Solid Handle Ø 6 mm

CLEOIDS

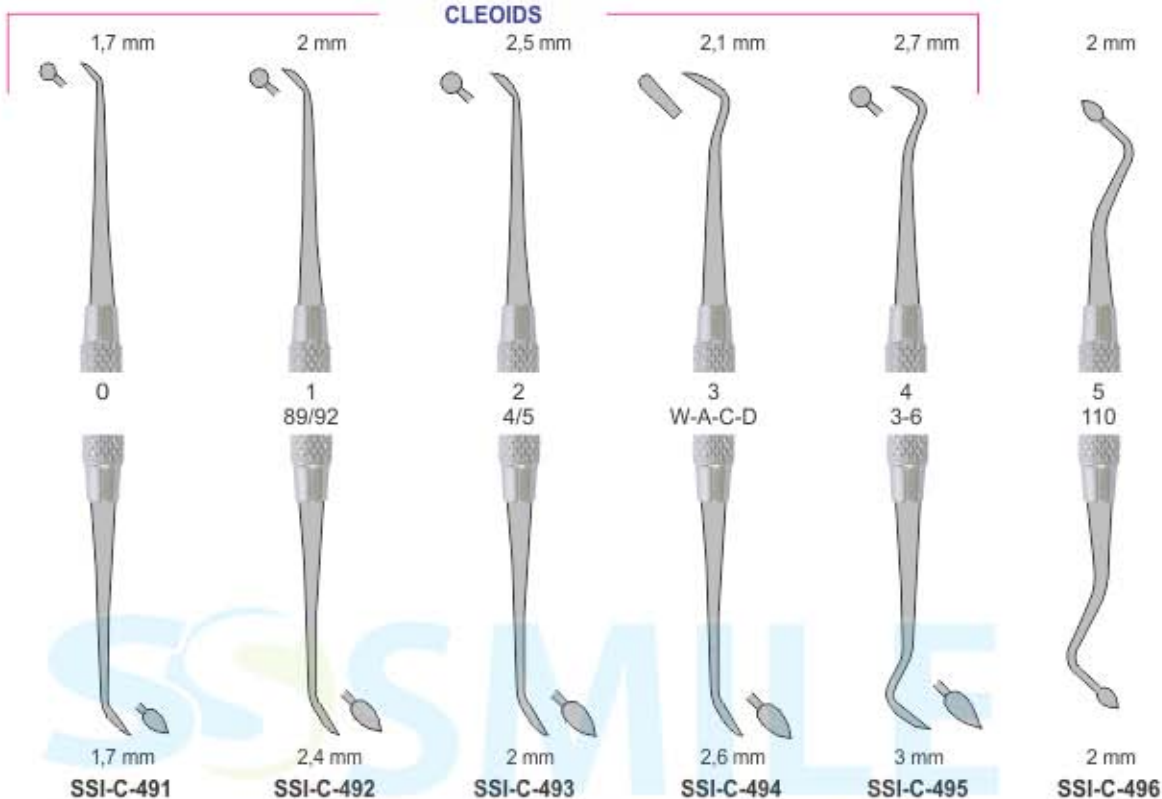

Nystrom

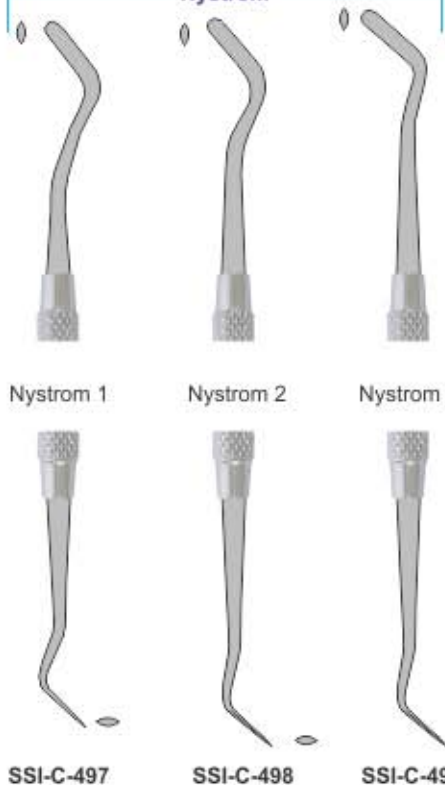

CHISELS



PREMIUM QUALITY DENTAL INSTRUMENTS

Инструменты для реставрации
Instruments pour plombage
Füllungsinstrumente (mit Kontrawinkel)

Инструменти для реставрації
Instrumentos para obturaciones
ملء الصنوك

ENAMEL INSTRUMENTS

Available in Hollow Handle Ø 8 mm, Ø 10 mm Solid Handle Ø 6 mm

MARGINTRIMMERS

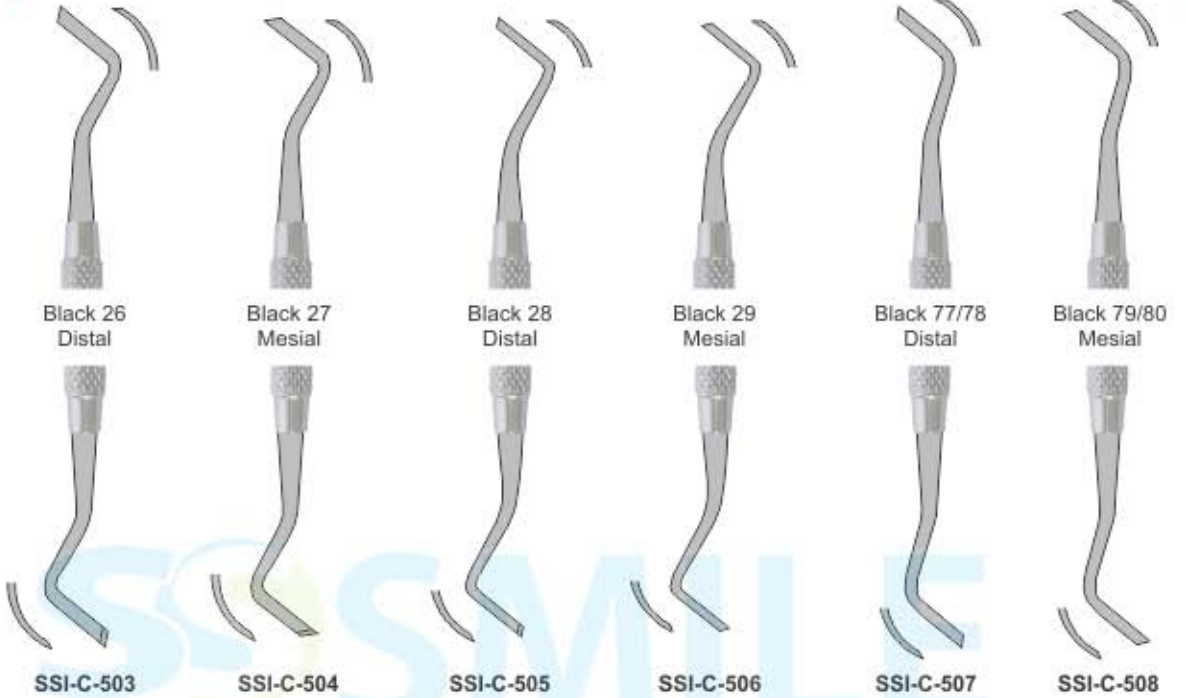

HATCHES

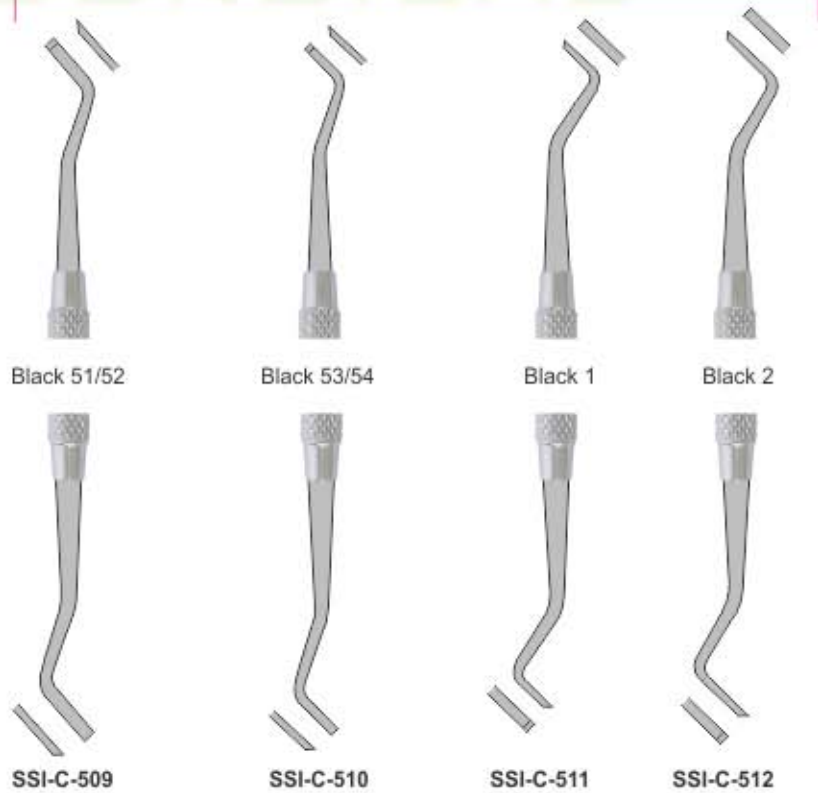

PREMIUM QUALITY DENTAL INSTRUMENTS

■ Инструменты для реставрации ■ Инструменти для реставрації
■ Instruments pour plombage ■ Instrumentos para obturaciones
■ Füllungsinstrumente (mit Kontrawinkel) ■ ملء الصكوك

Available in Hollow Handle Ø 8 mm, Ø 10 mm Solid Handle Ø 6 mm
CHISELS



Инструменты для реставрации
Instruments pour plombage
Füllungsinstrumente (mit Kontrawinkel)

Инструменти для реставрації
Instrumentos para obturaciones
ملء الصكوك

Available in Hollow Handle Ø 8 mm, Ø 10 mm Solid Handle Ø 6 mm

Heidemann Spatulas

SPATULAS



Heidemann Spatulas			SPATULAS		
2 mm	2,5 mm	3 mm	1,7 mm	1,9 mm	2,5 mm
1	2	3	PF1A	PF1	11
2 mm	2,5 mm	3 mm	ø 0,9 mm	ø 1,15 mm	2,5 mm
SSI-C-522	SSI-C-523	SSI-C-524	SSI-C-525	SSI-C-526	SSI-C-527
2,5 mm	2,3 mm	1,4 mm	1,6 mm	2,2 mm	2,6 mm
6	179	10	11	12	13
3 mm	2,3 mm	1,4 mm	1,5 mm	2,2 mm	2,6 mm
SSI-C-528	SSI-C-529	SSI-C-530	SSI-C-531	SSI-C-532	SSI-C-533

■ Экскаваторы ■ Экскаватори
 ■ Excavateurs ■ Excavadores
 ■ Excavatoren ■ حفرات

Available in Hollow Handle Ø 8 mm, Ø 10 mm Solid Handle Ø 6 mm

Oval Spoon



Oval spoon 17W Oval spoon 18W Oval spoon 19W



Spoon

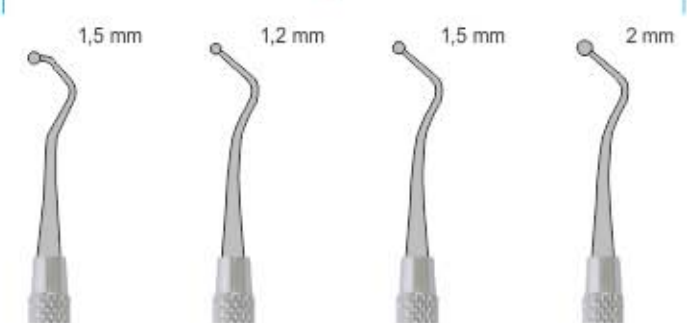

14 Spoon 17 Spoon 18 Spoon 19 Spoon

SSI-C-534 SSI-C-535 SSI-C-536 SSI-C-537 SSI-C-538 SSI-C-539 SSI-C-540

DENTINS REMOVALS

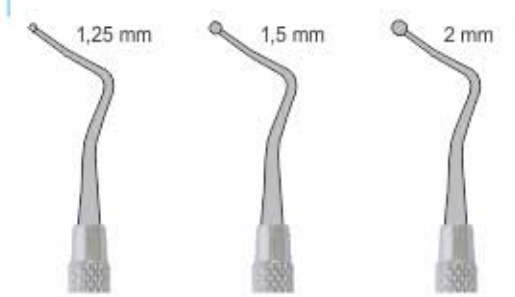

31L Endodontic excavators 32L Endodontic excavators 33L Endodontic excavators



Spoon



38/39 Spoon 63/64 65/66

SSI-C-541 SSI-C-542 SSI-C-543 SSI-C-544 SSI-C-545 SSI-C-546



- Экскаваторы
- Excavateurs
- Excavatoren
- Excavatori
- Excavadores
- حفارات

Available in Hollow Handle Ø 8 mm, Ø 10 mm Solid Handle Ø 6 mm



Экскаваторы
Excavateurs
Excavatoren

Экскаватори
Excavadores
حظرات

Spoon Excavators Round Shape
Available in Hollow Handle Ø 8 mm, Ø 10 mm Solid Handle Ø 6 mm



Зонды
Sondes
Zahnsonden

Зонди
Sondas
المستكشفين

PROBES



SSI-C-569
Probe



SSI-C-570
Probe



SSI-C-571
Probe



SSI-C-572
Probe

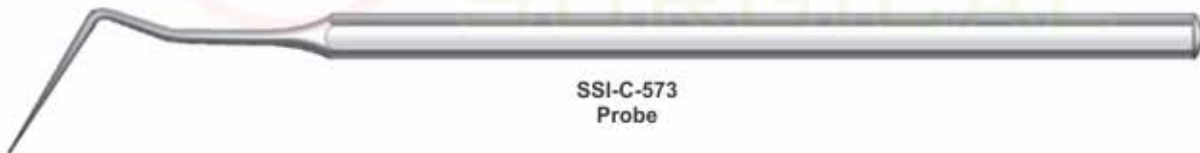

SSI-C-573
Probe



SSI-C-574
Probe



SSI-C-575
Probe



SSI-C-576
Probe

Инструменты пародонтологические
 Instruments pour la parodontologie
 Instrumente für die Parodontologie

Інструменти пародонтологічні
 instrumentos para periodoncia
 الصكوك اللثة



SSI-C-577
 Excavator



SSI-C-578
 Excavator



SSI-C-579
 Excavator



SSI-C-580
 Filling Instruments



SSI-C-581
 Filling Instruments



SSI-C-582
 Filling Instruments



SSI-C-583
 Filling Instruments

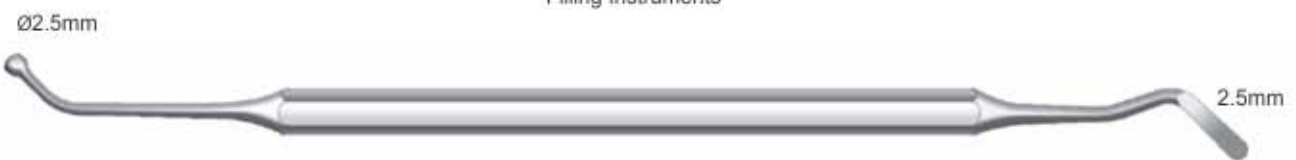

SSI-C-584
 Filling Instruments



SSI-C-585
 Cement Spatula

Инструменты пародонтологические
Instruments pour la parodontologie
Instrumente für die Parodontologie

Инструменти пародонтологічні
instrumentos para periodoncia
الصكوك اللثة

MODELLING INSTRUMENTS



Инструменты пародонтологические
Instruments pour la parodontologie
Instrumente für die Parodontologie

Инструменти пародонтологічні
instrumentos para periodoncia
الصكوك للثة

Periodontal Instruments Set



Cotton Meriam Tweezer

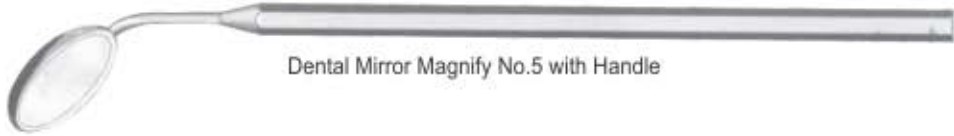

Dental Mirror Magnify No.5 with Handle

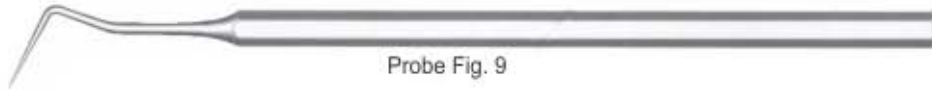

Probe Fig. 9



Excavator Tip Size Ø2mm-1,5mm



Excavator Tip Size Ø1,2mm-1,5mm



Plugger Tip Size Ø1,5mm-2mm



Plugger Tip Size Ø2mm-2,5mm



Ironing Crescent Tip Size Ø3mm-3,2mm



Ironing Crescent Tip Size Ø2,5mm-2,5mm



Cement Spatula Tip Size 6mm



SSI-C-594
Set of 10 Pieces.

Инструменты пародонтологические
Instruments pour la parodontologie
Instrumente für die Parodontologie

Инструменти пародонтологічні
instrumentos para periodoncia
الصكوك اللثة

Periodontal Files

Available in Hollow Handle Ø 8 mm, Ø 10 mm Solid Handle Ø 6 mm

Sugarman File Set

Excellent to remove and to crush strong calculus deposits



SSI-C-595
9/10
Schluger
Curved File

SSI-C-596
11/12
Buck
Straight File

SSI-C-597
1S/2S
Sugarman File

SSI-C-598
3S/4S
Sugarman File

SSI-C-599
3-7
Hirschfeld

SSI-C-600
5-11
Hirschfeld

SSI-C-601
9-10
Hirschfeld

Инструменты пародонтологические
Instruments pour la parodontologie
Instrumente für die Parodontologie

Инструменти пародонтологічні
instrumentos para periodoncia
الصكوك اللثة

Periodontal Files

Available in Hollow Handle Ø 8 mm, Ø 10 mm Solid Handle Ø 6 mm

SSI-C-602
Sugarman File Set

Excellent to remove and to crush strong calculus deposits

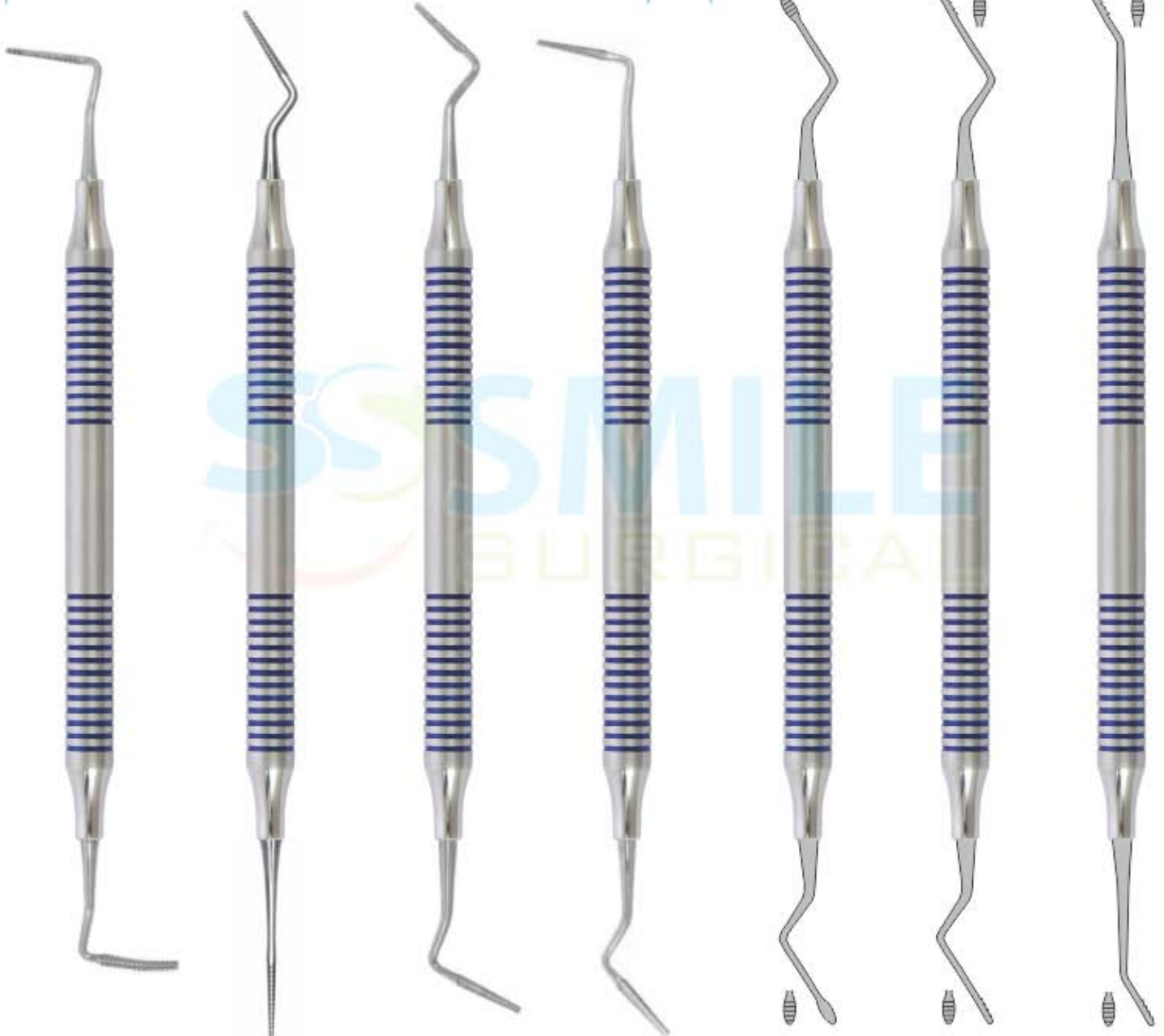

SSI-C-603
9/10
Schluger
Curved File

SSI-C-604
11/12
Buck
Straight File

SSI-C-605
1S/2S
Sugarman File

SSI-C-606
3S/4S
Sugarman File

SSI-C-607
3-7
Hirschfeld

SSI-C-608
5-11
Hirschfeld

SSI-C-609
9-10
Hirschfeld

- | | |
|----------|---------|
| Кюрети | Кюрети |
| Curetas | Curette |
| Küretten | كورتس |

Gracey Curettes Solid Handle Ø 6 mm, Length 170mm



SSI-C-610
1/2

SSI-C-611
3/4

SSI-C-612
5/6

SSI-C-613
7/8

SSI-C-614
9/10

SSI-C-615
11/12

SSI-C-616
13/14

SSI-C-617
15/16

SSI-C-618
17/18

- | | |
|---|---|
|  Кюрети |  Кюрети |
|  Curetas |  Curette |
|  Küretten |  كيرتس |

Gracey Currettes Hollow Handle Ø 10 mm, Length 170mm



SSI-C-619
1/2

SSI-C-620
3/4

SSI-C-621
5/6

SSI-C-622
7/8

SSI-C-623
9/10

SSI-C-624
11/12

SSI-C-625
13/14

SSI-C-626
15/16

SSI-C-627
17/18

■ Кюрети ■ Кюрети
■ Curetas ■ Curette
■ Küretten ■ كورتن

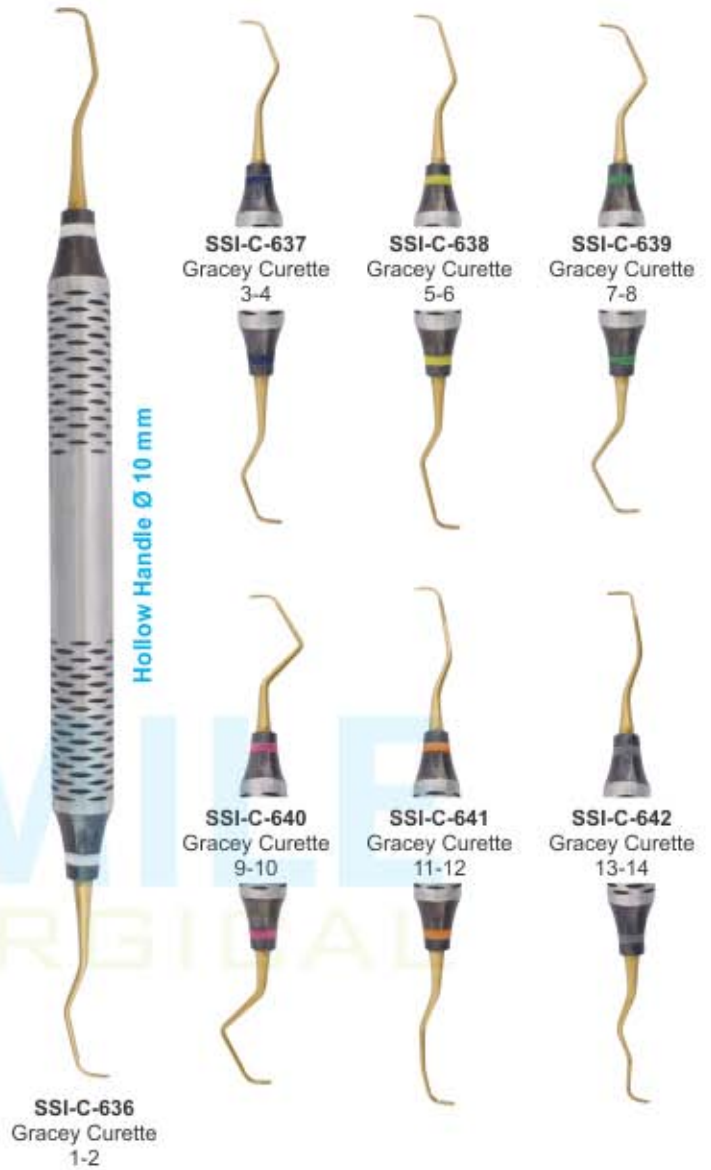
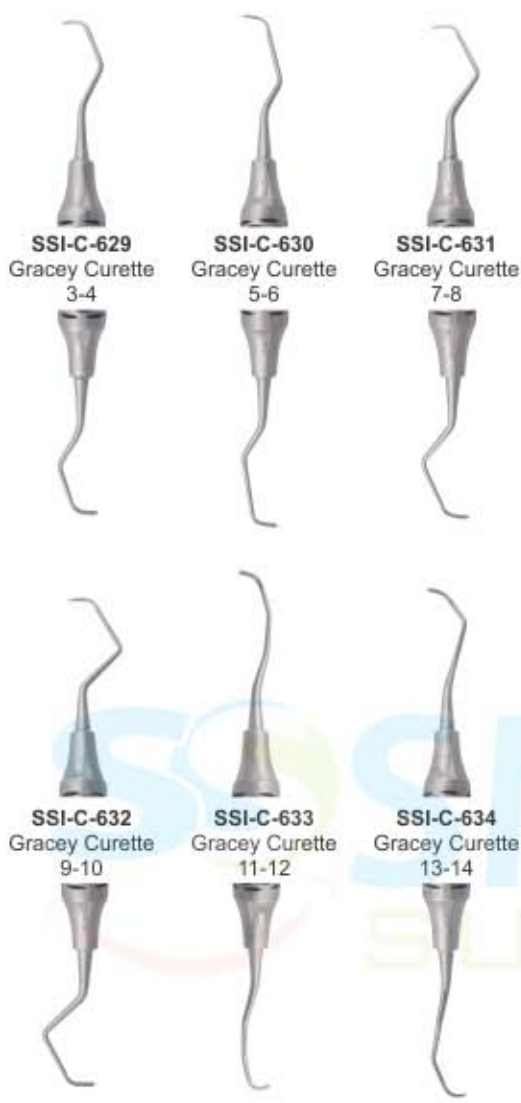

Please Ask for Special Packing of Gracey Curettes Above

- SSI-C-635**
Gracey Curette Set of 7 Pcs
Gracey Curette 1-2
Gracey Curette 3-4
Gracey Curette 5-6
Gracey Curette 7-8
Gracey Curette 9-10
Gracey Curette 11-12
Gracey Curette 13-14



Please Ask for Special Packing of Gracey Curettes Above

- SSI-C-643**
Gracey Curette
(Black & Gold Coating)
Set of 7 Pcs
Gracey Curette 1-2
Gracey Curette 3-4
Gracey Curette 5-6
Gracey Curette 7-8
Gracey Curette 9-10
Gracey Curette 11-12
Gracey Curette 13-14

■ Кюрети
■ Curetas
■ Küretten
■ Кюрети
■ Curette
■ کورتن



Please Ask for Special Packing of Gracey Curettes Above



SSI-C-651
 Gracey Curette Set of 7 Pcs
 Gracey Curette 1-2
 Gracey Curette 3-4
 Gracey Curette 5-6
 Gracey Curette 7-8
 Gracey Curette 9-10
 Gracey Curette 11-12
 Gracey Curette 13-14

SSI-C-659
 Gracey Curette Set of 7 Pcs
 with Silicon Handle
 Gracey Curette 1-2
 Gracey Curette 3-4
 Gracey Curette 5-6
 Gracey Curette 7-8
 Gracey Curette 9-10
 Gracey Curette 11-12
 Gracey Curette 13-14



Кюрети	Кюрети
Curetas	Curette
Küretten	كورتس

HOLLOW HANDLE PLASMA BLUE COATED Ø 10 MM, LENGTH 170MM

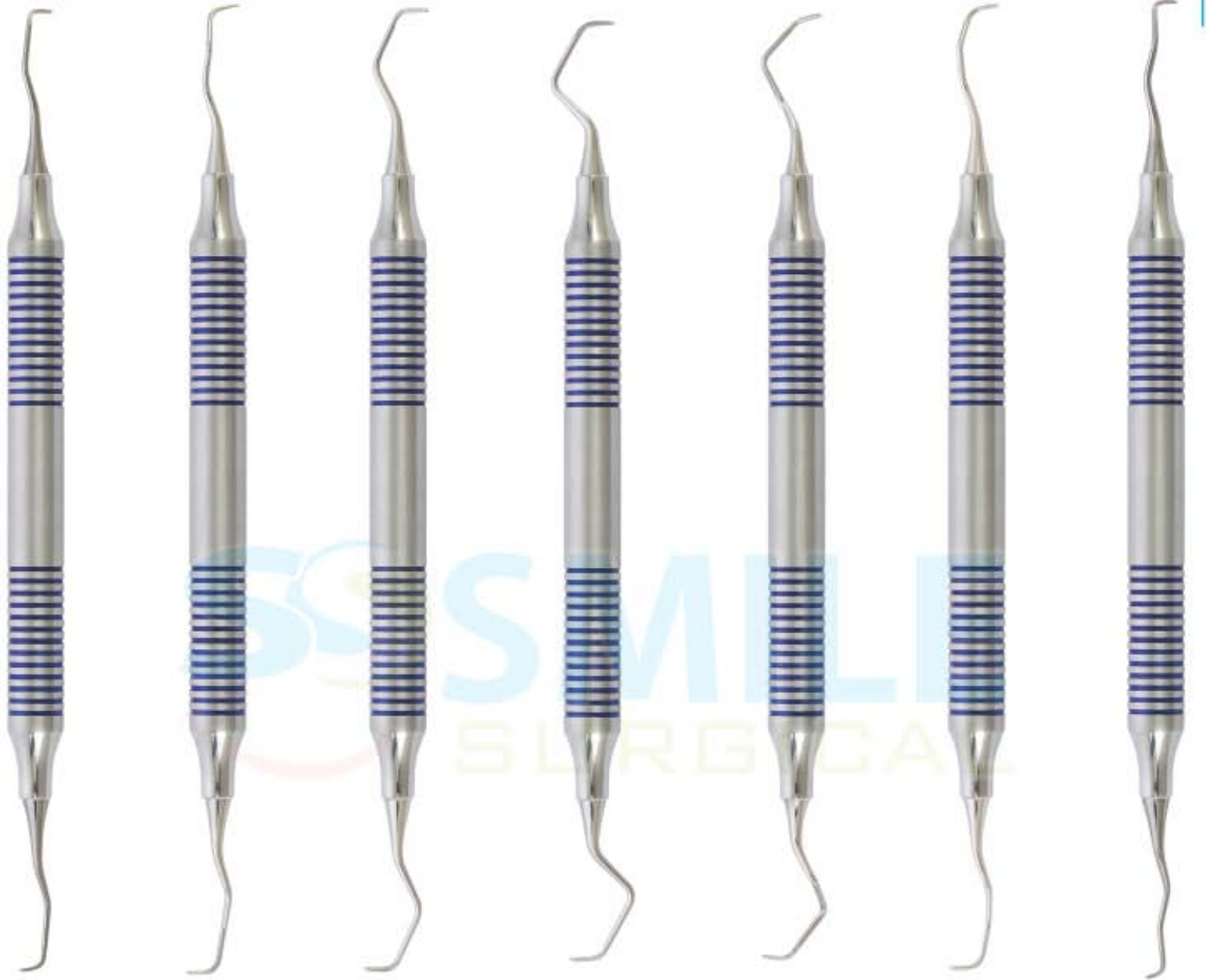

SSSI-C-660
GRACEY
1/2

SSSI-C-661
GRACEY
3/4

SSSI-C-662
GRACEY
5/6

SSSI-C-663
GRACEY
7/8

SSSI-C-664
GRACEY
9/10

SSSI-C-665
GRACEY
11/12

SSSI-C-666
GRACEY
13/14

Please Ask for Special Packing of Gracey Curettes Above



SSSI-C-667

Gracey Curettes Set of 7 Pcs

- Gracey Curettes 1/2
- Gracey Curettes 3/4
- Gracey Curettes 5/6
- Gracey Curettes 7/8
- Gracey Curettes 9/10
- Gracey Curettes 11/12
- Gracey Curettes 13/14

■ Кюрети	■ Кюрети
■ Curetas	■ Curette
■ Küretten	■ كرتش

HOLLOW HANDLE Ø 10 MM, LENGTH 170MM WITH SILICON RING



Please Ask for Special Packing of Gracey Curettes Above



SSI-C-675
Gracey Curettes Set of 7 Pcs
Gracey Curettes 1/2
Gracey Curettes 3/4
Gracey Curettes 5/6
Gracey Curettes 7/8
Gracey Curettes 9/10
Gracey Curettes 11/12
Gracey Curettes 13/14

Кюрети	Кюрети
Curetas	Curette
Küretten	كورش

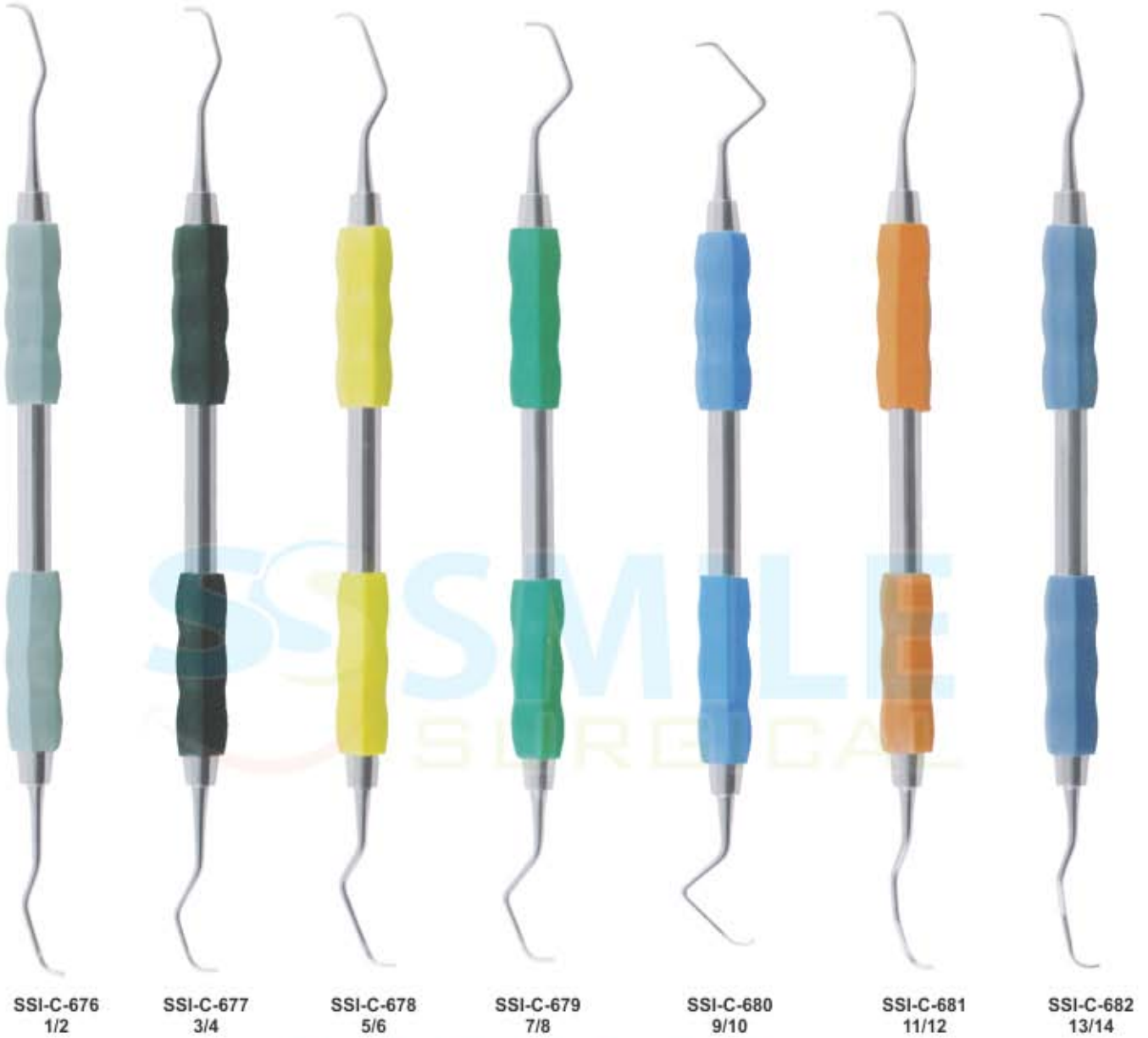

Please Ask for Special Packing of Gracey Curettes Above



SSI-C-683
Gracey Curettes Set of 7 Pcs with Silicon Grip
Gracey Curettes 1/2
Gracey Curettes 3/4
Gracey Curettes 5/6
Gracey Curettes 7/8
Gracey Curettes 9/10
Gracey Curettes 11/12
Gracey Curettes 13/14

- | | |
|--|---|
|  Кюрети |  Кюрети |
|  Curetas |  Curette |
|  Küretten |  كيرتس |

Silicone Handles



SSI-C-684
Explorer 1



SSI-C-685
Explorer 2



SSI-C-686
Explorer 3



SSI-C-687
Root Canal Spreader 1



SSI-C-688
Root Canal Spreader 2



SSI-C-689
Root Canal Spreader 3



SSI-C-690
Root Canal Spreader 4



SSI-C-691
Amalgam
Instruments 1



SSI-C-692
Amalgam
Instruments 2



SSI-C-693
Amalgam
Instruments 3



SSI-C-694
Amalgam
Instruments 4



SSI-C-695
Amalgam
Instruments 5



SSI-C-696
Amalgam
Instruments 6

Кюрети	Кюрети
Curetas	Curette
Küretten	كورتس



SSI-C-697
Filling Instruments 1



SSI-C-698
Filling Instruments 2



SSI-C-699
Filling Instruments 3



SSI-C-700
Filling Instruments 4



SSI-C-701
Filling Instruments 5



SSI-C-702
Lucas Currettes 1



SSI-C-703
Lucas Currettes 2



SSI-C-704
Lucas Currettes 3



SSI-C-705
Lucas Currettes 4



SSI-C-706
Lucas Currettes 5

■ Кюрети ■ Кюрети
■ Curetas ■ Curette
■ Küretten ■ كرتس

GRACEY MINI FIVE

HOLLOW HANDLE Ø 10 MM, LENGTH 170MM
CERAMIC COATED HANDLE



SSI-C-707 Gracey 1/2
SSI-C-708 Gracey 3/4
SSI-C-709 Gracey 5/6
SSI-C-710 Gracey 7/8
SSI-C-711 Gracey 11/12
SSI-C-712 Gracey 13/14

GRACEY AFTER FIVE

HOLLOW HANDLE Ø 10 MM, LENGTH 170MM
CERAMIC COATED HANDLE



SSI-C-713 Gracey 1/2 AF
SSI-C-714 Gracey 3/4 AF
SSI-C-715 Gracey 5/6 AF
SSI-C-716 Gracey 7/8 AF
SSI-C-717 Gracey 11/12 AF
SSI-C-718 Gracey 13/14 AF

■ Инструменты пародонтологические
■ Instruments pour la parodontologie
■ Instrumente für die Parodontologie

■ Инструменти пародонтологічні
■ instrumentos para periodoncia
■ الصكوك اللثة

Sickle Scalers Instruments

Available in Hollow Handle Ø 8 mm, Ø 10 mm Solid Handle Ø 6 mm



SSI-C-719
H6/H7
Hygienist

SSI-C-720
6/7
Goldman

SSI-C-721
U15
Towner

SSI-C-722
H5/U15
Hygienist-
Towner

SSI-C-723
U15/30
Towner-
Jacquette

SSI-C-724
H15/33†
Hygienist-
Jacquette

SSI-C-725
U15/33
Towner-
Jacquette

■ Инструменты пародонтологические
■ Instruments pour la parodontologie
■ Instrumente für die Parodontologie

■ Інструменти пародонтологічні
■ instrumentos para periodoncia
■ الصكوك اللثة

PERIODONTAL INSTRUMENTS

Available in Hollow Handle Ø 8 mm, Ø 10 mm Solid Handle Ø 6 mm

JACQUETTE SCALERS

CRANE-KAPLAN



SSI-C-726
30/33
Hygienist
Jacquette

SSI-C-727
31/32
Jacquette

SSI-C-728
34/35
Jacquette

SSI-C-729
H3/H4
Jacquette

SSI-C-730
14/15
Posterior
Jacquette

SSI-C-731
CK-6

■ Инструменты пародонтологические
■ Instruments pour la parodontologie
■ Instrumente für die Parodontologie

■ Инструменти пародонтологічні
■ instrumentos para periodoncia
■ الصكوك اللثة

PERIODONTAL INSTRUMENTS

Available in Hollow Handle Ø 8 mm, Ø 10 mm Solid Handle Ø 6 mm

SCALER CURETTE



Инструменты пародонтологические
Instruments pour la parodontologie
Instrumente für die Parodontologie

Инструменти пародонтологічні
intrumentos para periodoncia
الصكوك اللثة

SICKLE SCALERS INSTRUMENTS

Available in Hollow Handle Ø 8 mm, Ø 10 mm Solid Handle Ø 6 mm

SICKLE SCALERS



SSI-C-739
H6/H7
Hygienist

SSI-C-740
6/7
Goldman

SSI-C-741
U15
Towner

SSI-C-742
H5/U15
Hygienist-
Towner

SSI-C-743
U15/30
Towner-
Jacquette

SSI-C-744
H15/33†
Hygienist-
Jacquette

SSI-C-745
U15/33
Towner-
Jacquette

■ Инструменты пародонтологические
■ Instruments pour la parodontologie
■ Instrumente für die Parodontologie

■ Инструменти пародонтологічні
■ instrumentos para periodoncia
■ الصكوك اللثة

PERIODONTAL INSTRUMENTS

Available in Hollow Handle Ø 8 mm, Ø 10 mm Solid Handle Ø 6 mm

JACQUETTE SCALERS

CRANE-KAPLAN



Инструменты пародонтологические
 Instruments pour la parodontologie
 Instrumente für die Parodontologie

Инструменти пародонтологічні
 instrumentos para periodoncia
 الصكوك اللثة

PERIODONTAL INSTRUMENTS

Available in Hollow Handle Ø 8 mm, Ø 10 mm Solid Handle Ø 6 mm

SCALER CURETTE



SSI-C-752
11/12
Scaler

SSI-C-753
11A/12A
Scaler

SSI-C-754
11/12S
Modief
McCall

SSI-C-755
13S/14S
Pointed
Curette

SSI-C-756
MTC 13/14
Pointed
Curette

SSI-C-757
17S/18S
Curette

SSI-C-758
19/20
Curette

■ Стоматологический набор скейлеров
■ Instruments a detartrer
■ Zahnreiniger

■ Стоматологічний набір скейлерів
■ Limpiadores de sarro
■ المتسلفون

SCALERS
Solid Handle Ø 6 mm



SSI-C-759

SSI-C-760

SSI-C-761

SSI-C-762

SSI-C-763

SSI-C-764

SSI-C-765

■ Стоматологический набор скейлеров
■ Instruments a detartre
■ Zahnreiniger

■ Стоматологічний набір скейлерів
■ Limpiadores de sarro
■ المسكفون

Tartar Remover Instruments
Solid Handle Ø 6 mm



SSI-C-766
Fig. 1

SSI-C-767
Fig. 1L
Left

SSI-C-768
Fig. 1R
Right

SSI-C-769
Fig. 2L
left

SSI-C-770
Fig. 2R
Right

SSI-C-771

SSI-C-772

SSI-C-773

Инструменты пародонтологические
Instruments pour la parodontologie
Instrumente für die Parodontologie

Инструменти пародонтологічні
instrumentos para periodoncia
الصكوك اللثة

Available in Hollow Handle Ø 8 mm, Ø 10 mm Solid Handle Ø 6 mm

PERIODONTAL KNIVES



SSI-C-774
1
Reddy Thin

SSI-C-775
2
Reddy Thin

SSI-C-776
3/4
Buck

SSI-C-777
5/6
Buck

SSI-C-778
1/2
Solt

SSI-C-779
1/2
Sanders

SSI-C-780
USC Towner
19/20

SSI-C-781
CK-3
Crane Kaplan

SSI-C-782
Dr. Allen
End-Cutting
Intraculcular Knife

Инструменты пародонтологические
Instruments pour la parodontologie
Instrumente für die Parodontologie

Инструменти пародонтологічні
intrumentos para periodoncia
الصكوك اللثة

Available in Hollow Handle Ø 8 mm, Ø 10 mm Solid Handle Ø 6 mm

PERIODONTAL KNIVES



SSI-C-783
15K/16K
Kirkland

SSI-C-784
1/2
Orban

SSI-C-785
1/2 Orban
Knife

SSI-C-786
7
Goldman-Fox

SSI-C-787
8
Goldman-Fox

SSI-C-788
9
Goldman-Fox

SSI-C-789
11
Goldman-Fox

■ Инструменты пародонтологические
■ Instruments pour la parodontologie
■ Instrumente für die Parodontologie

■ Инструменти пародонтологічні
■ instrumentos para periodoncia
■ الصكوك اللثة

PERIODONTAL CHISELS

Available in Hollow Handle Ø 8 mm, Ø 10 mm Solid Handle Ø 6 mm

OCHSENBEIN

FEDI



SSI-C-790
1
Ochsensbein

SSI-C-791
2
Ochsensbein

SSI-C-792
3
Ochsensbein

SSI-C-793
4
Ochsensbein

SSI-C-794
1
Fedi

SSI-C-795
2
Fedi

SSI-C-796
3
Fedi

SSI-C-797
4
Fedi

■ Инструменты для костной ткани
■ Limes a os
■ Knochenfeilen

■ Инструменти для кісткової тканини
■ Limas para huesos
■ ملفات العظام



SSI-C-798
Fig. 1
PoloKoff



SSI-C-799
Fig. 33



SSI-C-800
Fig. 45
Miller



SSI-C-801
Fig. 64
Miller



SSI-C-802
Fig. 10



SSI-C-803
Fig. 1
Wahl



SSI-C-804
Fig. 2
Wahl



SSI-C-805
Fig. 12
Howard



SSI-C-806
Fig. 12A



SSI-C-807
Fig. 12CA

■ Инструменты пародонтологические
■ Instruments pour la parodontologie
■ Instrumente für die Parodontologie

■ Инструменти пародонтологічні
■ instrumentos para periodoncia
■ الصكوك اللثة

PERIODONTAL CHISELS

Available in Hollow Handle Ø 8 mm, Ø 10 mm Solid Handle Ø 6 mm



SSI-C-808
1/2
Kramer-Nevins

SSI-C-809
36/37
Rhodes
Back-Action

SSI-C-810
44/45
Remington
Hoe

SSI-C-811
TG

SSI-C-812
TG-0
Modified TG with
Ochsenein cutouts

SSI-C-813
3/4
Solt

SSI-C-814
13K/TG

SSI-C-815
13K/13KL

BONE CURETTES

Available in Hollow Handle Ø 8 mm, Ø 10 mm Solid Handle Ø 6 mm



SSI-C-816
Hemingway

SSI-C-817
Hemingway

SSI-C-818
Hemingway

SSI-C-819
Martin

SSI-C-820
Martin

SSI-C-821
Martin

- | | |
|----------|---------|
| Кюрети | Кюрети |
| Curetas | Curette |
| Küretten | کورتس |

LUCAS SPOON SHAPE

Available in Hollow Handle Ø 8 mm, Ø 10 mm Solid Handle Ø 6 mm

LUCAS



SSI-C-822
84

SSI-C-823
85

SSI-C-824
86

SSI-C-825
87

SSI-C-826
88

SSI-C-827
85/86
Lucas
Surgical Curette

SSI-C-828
86/87
Lucas
Surgical Curette

SSI-C-829
Lucas

SSI-C-830
Lucas

■ Инструменты для реставрации
■ Instruments pour plombage
■ Füllungsinstrumente (mit Kontrawinkel)

■ Інструменти для реставрації
■ Instrumentos para obturaciones
■ ملء الصكوك

P.K. THOMAS WAXING INSTRUMENTS

P.K. THOMAS WAX CARVER SET OF 5 PCS

Available in Hollow Handle Ø 8 mm, Ø 10 mm Solid Handle Ø 6 mm



SSI-C-831 PKT-1 SSI-C-832 PKT-2 SSI-C-833 PKT-3 SSI-C-834 PKT-4 SSI-C-835 PKT-5

P.K. THOMAS WAX CARVER SET OF 5 PCS

Aluminum Anodizing Colours Handle Ø 8 mm



SSI-C-837 PKT-1 SSI-C-838 PKT-2 SSI-C-839 PKT-3 SSI-C-840 PKT-4 SSI-C-841 PKT-5



SSI-C-836
P.k. Thomas Wax Carvers Set of 5 Pcs



SSI-C-842
P.k. Thomas Wax Carvers Set of 5 Pcs
with Sterilized Cassette

- Инструменты для реставрации
- Instruments pour plombage
- Füllungsinstrumente (mit Kontrawinkel)
- Инструменти для реставрації
- Instrumentos para obturaciones
- ملء الصكوك

COMPOSITE INSTRUMENTS TITANIUM BLUE ENDODONTIC

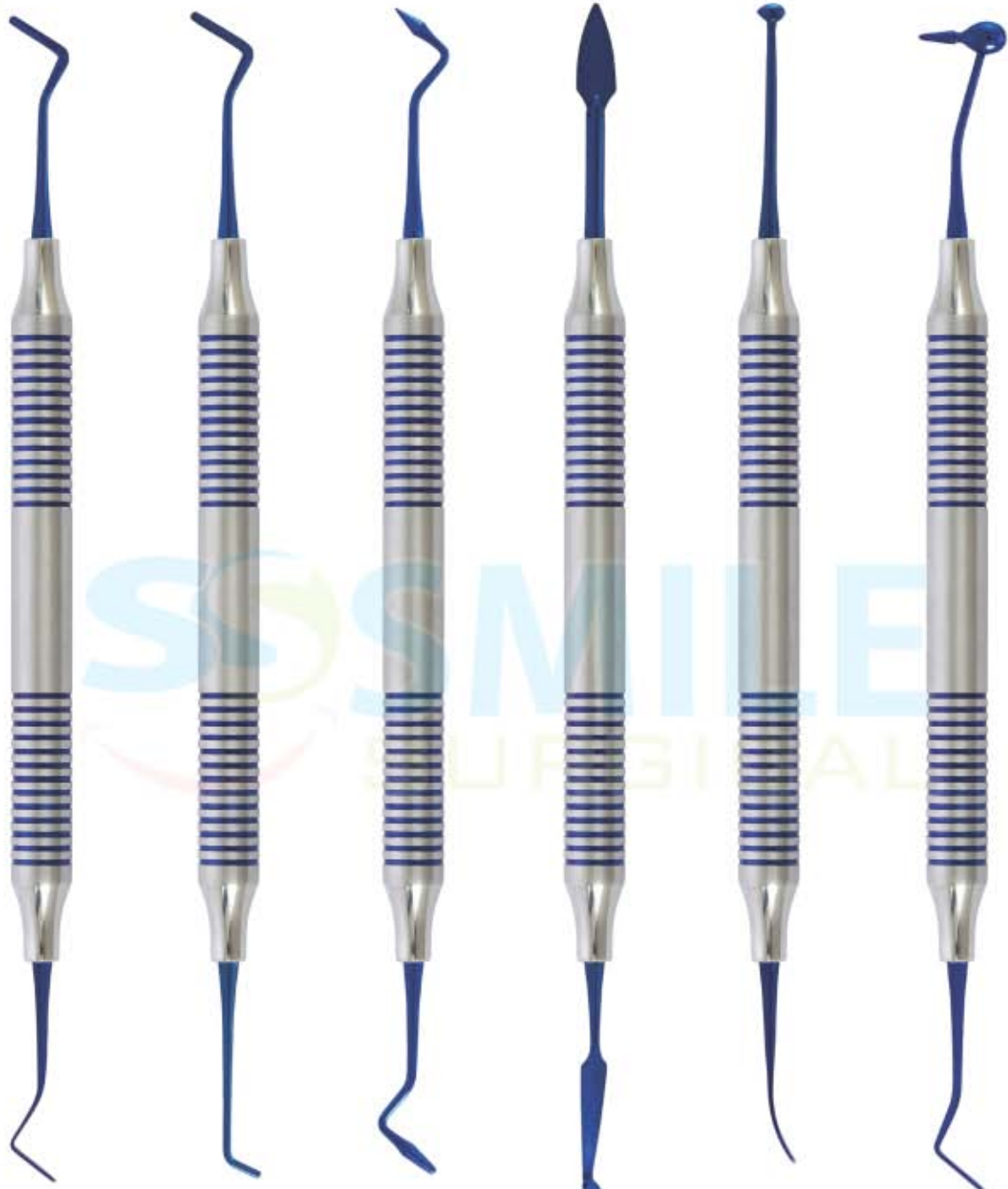

SSI-C-843

SSI-C-844

SSI-C-845

SSI-C-846

SSI-C-847

SSI-C-848



SSI-C-849
Composite Instruments Blue
Titanium with Cassettes

Шпатели для цемента
Spatules à ciment
Zementspatel

Шпатели для цементу
Espátulas para cemento
ملاعق الاسمنت

Available in Hollow Handle Ø 8 mm, Ø 10 mm Solid Handle Ø 6 mm



SSI-C-850
Fig. 1



SSI-C-851
Fig. 2



SSI-C-852
Fig. 3



SSI-C-853
Fig. 00



SSI-C-854
Fig. 0



SSI-C-855
Fig. 1



SSI-C-856
Fig. 2



SSI-C-857
Fig. 3



SSI-C-858
Fig. 4



SSI-C-859
Weston



SSI-C-860



SSI-C-861

Шпатели для цемента
Spatules à ciment
Zementspatel

Шпатели для цемента
Espátulas para cemento
ملاعق الأسمنت

Wax and Modelling Carvers



SSI-C-862
Le Cron

SSI-C-863
Zahle

SSI-C-864
Zahle

SSI-C-865
Zahle

SSI-C-866
Gritman

SSI-C-867
Beale

SSI-C-868
Roach

SSI-C-869
Vehe

Инструменты для реставрации
Instruments a modeler
Modellierinstrumente

Инструменти для реставрації
Instrumentos para modelar
ابوات تقطیع



SSI-C-870

Graded Handle Hylin Carver



SSI-C-871
Hylin

SSI-C-872
Hylin-Le Cron

SSI-C-873
Hylin-Ceramica

SSI-C-874
Hylin

SSI-C-875

SSI-C-876
Le Cron

SSI-C-877
Le Cron

SSI-C-878
Le Cron

Ножи для воска
Couteaux a cire
Wachsmesser

Ножи для воску
Cuchillos para cera
المسكين الشمع

WAX KNIVES



SSI-C-879
Fig. 1
Fahnenstock
125mm

SSI-C-880
Fig. 2
Fahnenstock
170mm

SSI-C-881
Fig. 1
Lessmann
125mm

SSI-C-882
Fig. 2
Lessmann
170mm

SSI-C-883
Fig. 1
with small spoon
125mm

SSI-C-884
Fig. 2
with large spoon
170mm

■ Ножи для воска
 ■ Couteaux a cire
 ■ Wachsmesser

■ Ножі для воску
 ■ Cuchillos para cera
 ■ المسكين الشمع

PLASTER KNIVES



SSI-C-885
160mm



SSI-C-886
160mm



SSI-C-887
Buffalo



SSI-C-888
Buffalo



SSI-C-889
Plaster Knife



SSI-C-890
170mm

Ножи для воска
Couteaux a cire
Wachsmesser

Ножи для воску
Cuchillos para cera
المسكين الشمع

WAX KNIVES



SSI-C-891
Sachs



SSI-C-892
130mm
Ermert



SSI-C-893
Hook Knives



SSI-C-894
125mm
Antkoviak



SSI-C-895



Special Inox
SSI-C-896 170mm
SSI-C-897 200mm

Шпатель для замешивания
Spatules a alginate et a platre
Alginat- und Gipsspatel

Шпатель для змішування
Espatulas para alginato y para yeso
ملاعق الجبس الجينات

WAX SPATULAS



SSI-C-898
Fig. 1
18.5 cm

SSI-C-899
Fig. 2
18 cm

SSI-C-900
Wooden Handle
195mm curved

SSI-C-901
Wooden Handle
200mm curved

SSI-C-902
Wooden Handle
225mm curved

SSI-C-903
Wooden Handle
195mm

SSI-C-904
Wooden Handle
215mm

SSI-C-905
Wooden Handle
205mm



Open View



Denture Flask
Lower, Brass
SSI-C-906
Close View



Open View



Denture Flask
Upper, Brass
SSI-C-907
Close View



Open View



Round Dental
Flask, Brass
SSI-C-908
Close View



Open View



Small Flask with
Compressor, Brass
SSI-C-909



Compressor Single Flask
SSI-C-910



Compressor Double Flask
SSI-C-911



Compressor Double Flask
SSI-C-912

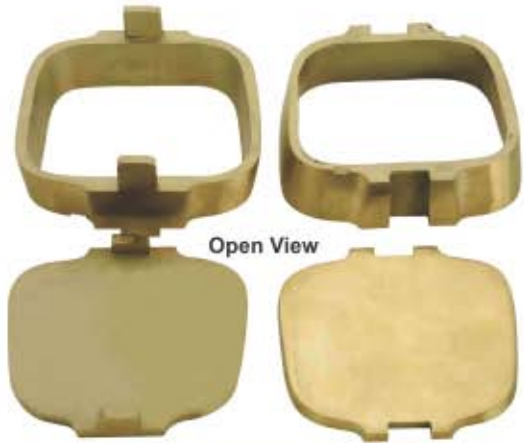

Open View



**Dental Flask
4 Parts, Brass
SSI-C-913
Close View**



Open View



**Dental Single
Flask, Brass
SSI-C-914
Close View**



Open View



**Dental Flask,
4 Parts Silver
SSI-C-915
Close View**



**Dyerline Flask,
Silver
SSI-C-916
Close View**



Open View



**Round Dental
Flask, Silver
SSI-C-917
Close View**



Open View

■ Артикуляторы
■ Artocilar
■ Artikulations

■ Артикулятори
■ Articuler
■ ارتیکولاتورس



SSI-C-918
Articulator



SSI-C-919
Articulator



SSI-C-920
Articulator
S



SSI-C-923
Articulator



SSI-C-921
Articulator
M



SSI-C-922
Articulator
L

■ Артикуляторы
■ Artocilar
■ Artikulations

■ Артикулятори
■ Articular
■ ارتیکو لاتورس



SSI-C-924
Articulator



SSI-C-925
Articulator



SSI-C-926
Articulator



SSI-C-927
Articulator



SSI-C-928
Articulator



SSI-C-929
Articulator

■ Артикуляторы
■ Artocilar
■ Artikulations

■ Артикулятори
■ Articuler
■ ارتيكولاتورس

SSI-C-930

Technical Datas:

Intercondylar distance	120 mm.
condylar inclination	fixed at 30°
Bennet angle	fixed at 7°
Incisal table inclination	10°
Distance between mounting plates	110 mm.
Weight	700 gr.
Opening	180°

features:

Lightweight anathomic articulator made of aluminum die-casting. it can be used following the geometrical laws of medium values (Bonwill triangle). Fixing according to centric. Automatic return to the hinge axis with springs. Perfect stability also in reclused position. Easy access and visibility to the lingual surfaces. interchangeable self centring aluminum mounting plates.



SSI-C-931

Technical Datas:

Intercondylar distance	120 mm.
condylar inclination	fixed at 30°
Bennet angle	fixed at 7°
Incisal table inclination	flat
Distance between mounting plates	110 mm.
Weight	700 gr.
Opening	180°

Special Features:

Adjustable back by registration screw to work without incisal rod by keeping constant trajectories and inclinations during side and back/forward movements. Pure translation movement (key and instructions included). Anti-shock hinge rod in case articulator falls down. Bigger size lock screws for mounting plates.



Increased height and width

- (1) More space when using removable stumps systems.
- (2) More space for installation of mobile prosthesis with high chewing or big base.
- (3) More space when using magnetic plates



SSI-C-932

Technical Datas:

Intercondylar distance	120 mm.
condylar inclination	fixed at 30°
Bennet angle	fixed at 7°
Incisal table inclination	10°
Distance between mounting plates	85 mm.
Weight	400 gr.
Opening (item 5000)	125°
Opening (item 5010)	180°



SSI-C-933

Technical Datas:

Intercondylar distance	110 mm.
condylar inclination	fixed at 30°
Bennet angle	fixed at 7°
Incisal table inclination	flat
Distance between mounting plates	85 mm.
Weight	450 gr.
Opening	180°



SSI-C-934
Anvil
Dental Laboratory
Instrument

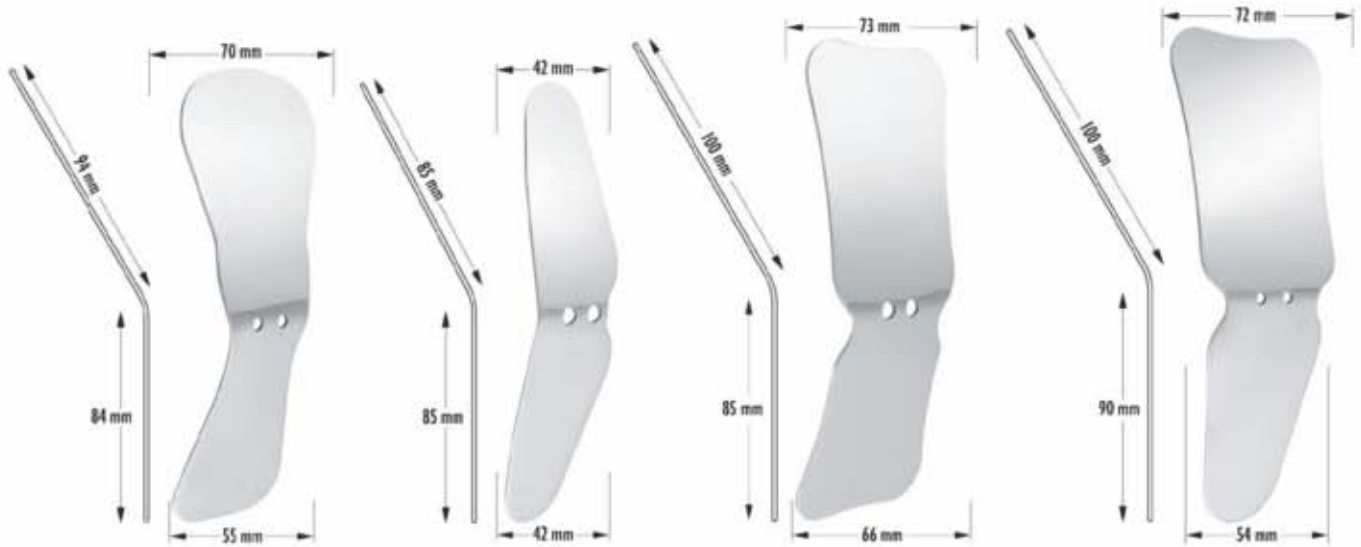

SSI-C-935 Adult Palatal /
SSI-C-936 Child Palatal

SSI-C-937
Buccal

SSI-C-938 Adult Palatal /
SSI-C-939 Child Palatal

SSI-C-940 Adult Palatal /
SSI-C-941 Adult Buccal



SSI-C-942 Lingual upper /
SSI-C-943 Lingual Lower

SSI-C-944 Adult Buccal /
SSI-C-945 Child Buccal

SSI-C-946 Child Palatal /
SSI-C-947 Child Buccal

SSI-C-948
Palatal-Adult

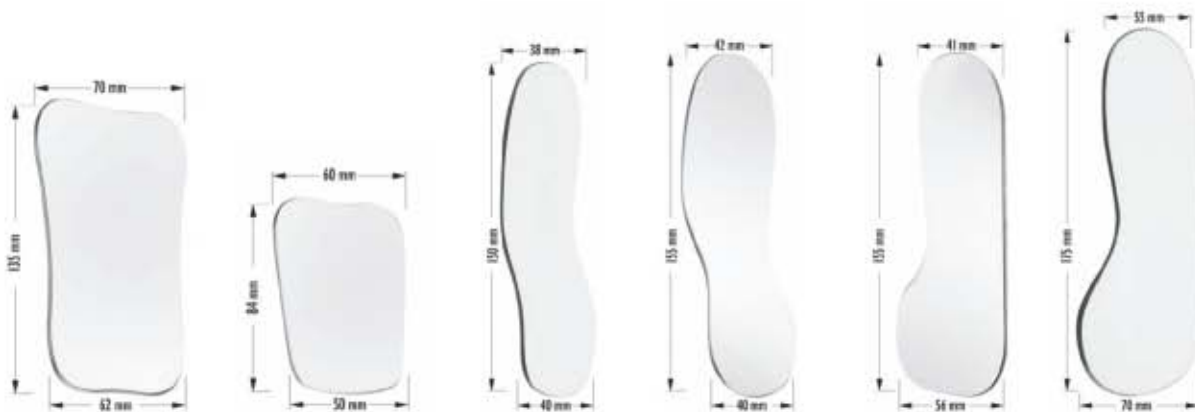

SSI-C-949
Palatal-Adult Large

SSI-C-950
Palatal-Child

SSI-C-951
Buccal-Small

SSI-C-952
Buccal

SSI-C-953
Lingual

SSI-C-954
Lingual-Large



SSI-C-955
Mirror with Electric
Battery

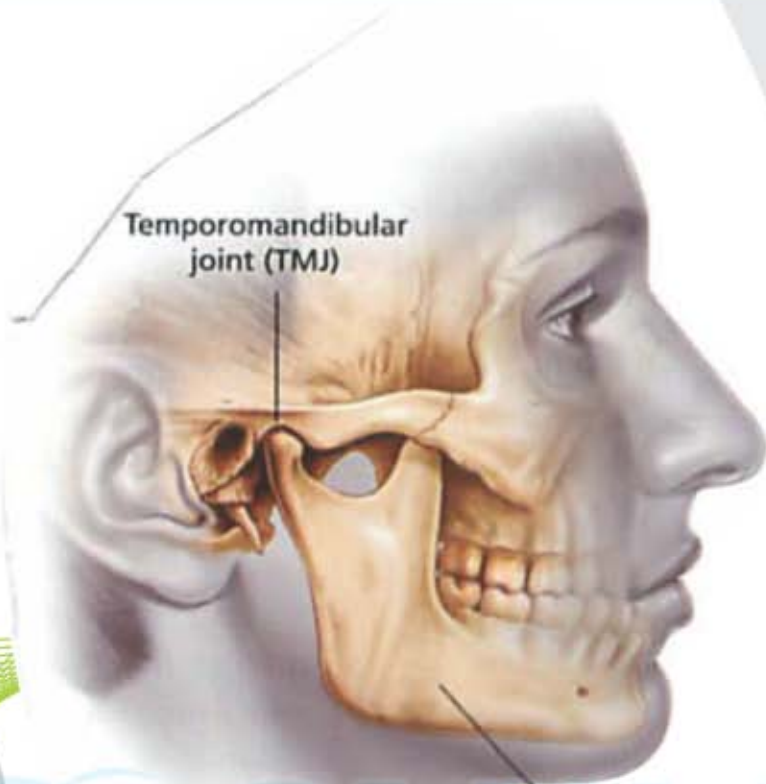

Temporomandibular
joint (TMJ)

Mandible



Maxillofacial Surgery Instruments

A Bard-Parker handle with a No. 15 blade is the usual scalpel used to make incisions on the gums where a flap can be raised to gain access to tooth.

Retractors

Tongue, cheek and flap retractors are needed to provide adequate access to the tooth and are legion in number.

Needle Holders and Sutures

Sutures are used to replace and secure the gum flap in its former position, to limit the size of the wound and therefore restrict subsequent contamination with food debris, and to assist in controlling bleeding.

The usual suture size for intra-oral work is 4/0 and the material may be absorbable or non-absorbable

Scissors

Dissecting scissors and suture-cutting scissors are usually used.

Artery Forceps

These are designed to hold soft tissue without damaging it.

College tweezers are used to lift up sutures prior to removing them.

Periosteal Elevators

A number are available and are similarly used like a normal elevator but periosteal elevators have two heads – one at each end.

One end is sharp-tipped to expand the tooth socket while the other has a blunt end to remove granulation tissues or raise a gum flap.

Chisels and Mallet

Chisels are more appropriate in the operating theatre and are particularly useful for disto-angular third molars and upper wisdom teeth extraction.

Bone Curettes

The Mitchells trimmer is probably the most valuable instrument in the category and is used to remove granulation tissue in the tooth socket.

Bone Ronguer and Bone File

Used to smoothen any sharp bone edges after tooth extraction is done.

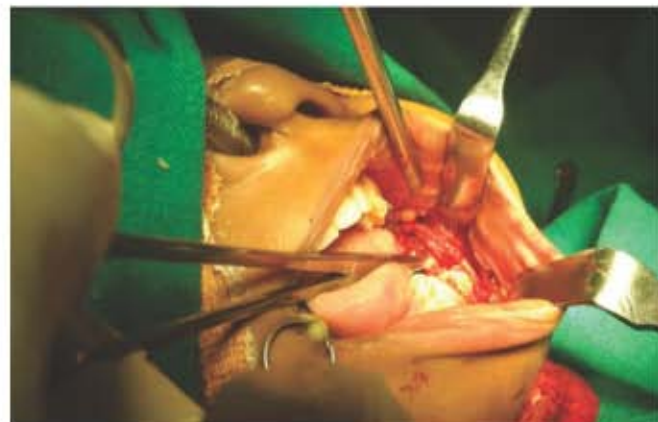

- Ручки для скальпелей
- Ручки для скальпелів
- Manches de bistouris
- Mangos de bisturi
- Skalpellgriffe
- مشرط مقابض

Scalpel Handles

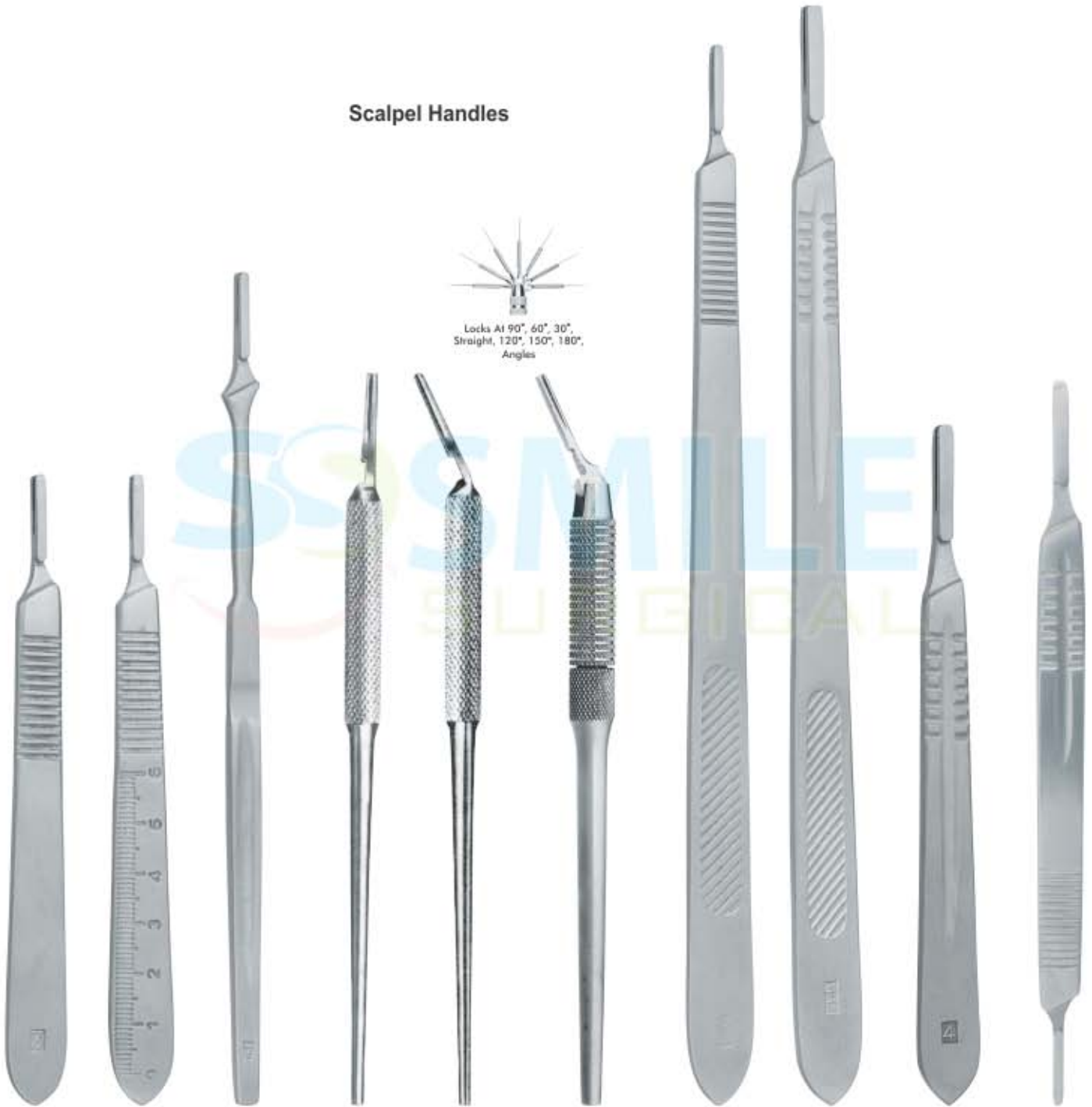

- SSI-D-001**
Fig. 3
125mm
- SSI-D-002**
Fig. 3
125mm
- SSI-D-003**
Fig. 7
165mm
- SSI-D-004**
Fig. 5
145mm
- SSI-D-005**
Fig. 5A
145mm
- SSI-D-006**
6 Way Adjustable
Angled
Scalpel Handle
- SSI-D-007**
Fig. 3L
210mm
- SSI-D-008**
Fig. 4L
218mm
- SSI-D-009**
Fig. 4
135mm
- SSI-D-009A**
Double Handle
No.4 + No.3
163mm

- Ножи для скальпеля и скальпеля
 ■ Ножи скальпельного леза та скальпеля
- Scalpel Blade & Scalpel Knives
 ■ Cuchillos de Escalpel y Escalpel
- Scalpel Blade & Scalpel Messer
 ■ مشرط شفرة و مشرط السكاكين

STERIL SCALPEL BLADES



SCALPEL KNIVES



PREMIUM QUALITY DENTAL INSTRUMENTS

- | | |
|----------------------|---------------------|
| ■ Скальпельные ножи | ■ Ножи скальпеля |
| ■ Couteaux à scalpel | ■ Cuchillos Scalpel |
| ■ Skalpellmesser | ■ سكاكين مشرط |



Dieffenbach
160mm



SSI-D-028
Fig. 1
160mm



SSI-D-029
Fig. 2
160mm



SSI-D-030
Fig. 3
160mm



SSI-D-031
Fig. 4
160mm



SSI-D-032
Fig. 5
160mm



SSI-D-033
Fig. 6
160mm



SSI-D-034
Fig. 7
160mm



SSI-D-035
Fig. 8
160mm



SSI-D-036
Fig. 9
160mm



SSI-D-037
Fig. 10
160mm



SSI-D-038
Fig. 15
160mm



SSI-D-039
Fig. 16
160mm

RETRACTORS - MOUTH GAGS

- Роторасширители
- Роторозширювачі
- Ecarteurs - Ouvre-bouches
- Separadores - Abre-bocas
- Vestibulumabhalter / Mundspanner
- الكاشطات والكعابيات الفم



SSI-D-040 105mm
SSI-D-041 135mm
Weitlaner
Fig. 1



SSI-D-042 105mm
SSI-D-043 135mm
Weitlaner
Fig. 2



SSI-D-044
Stainless Steel
Double
Ended Cheek
Retractors



SSI-D-045
Stainless Steel
Single
Ended Cheek
Retractors



SSI-D-046 110mm
SSI-D-047 130mm
SSI-D-048 150mm
Weitlander



SSI-D-049 110mm
SSI-D-050 130mm
SSI-D-051 150mm
Jennings



SSI-D-052
Denhard
120mm



SSI-D-053
Roser-Konig
160mm



SSI-D-054
Roser-Konig
190mm

Роторасширители

Ecarteurs - Ouvre-bouches

Vestibulumabhalter / Mundspanner

Роторозширювачі

Separadores - Abre-bocas

الكاشحات، الفصوات، الفم



SSSI-D-055
HMG
Heister
130mm



SSSI-D-056
Mouth Gag Molt
110mm for (Children)



SSSI-D-057
Mouth Gag Molt
140mm for (Adults)



SSSI-D-058
140mm

SSSI-D-059
150mm

Cheek Retractor



SSSI-D-060
Wangen Holder
150mm, with or without
lip protection



SSSI-D-061
Wangen Holder
150mm, with
or without lip protection



SSSI-D-062
Wangen Holder
Wangen holder with dual
function, 170mm



SSSI-D-063
Retractor with
Ergo Grip
240mm
ergonomic handle



SSSI-D-064
Cheek Retractor
Retractor Ivory
Width adjustable
& flexible, 200mm

PREMIUM QUALITY DENTAL INSTRUMENTS

Ранорасширители
Ecarteurs
Wundhaken

Ранорозширювачі
Separadores
الفاشحات

RETRACTORS



SSI-D-065
Columbia
14.5 cm



SSI-D-066
Sternberg
14 cm
Double Ended



SSI-D-067
Sternberg
16 cm



SSI-D-068
Sternberg
14 cm
Single Ended



SSI-D-069
Oringer Medium
11x8 cm



SSI-D-070
Brunings
Cheek Retractor
190mm



SSI-D-071
Minnesota
Small
140mm



SSI-D-072
Minnesota
Large
160mm



SSI-D-073
Cheek Retractor
200mm
Easy to Bend
by Hand



SSI-D-074
Cheek Retractor
Retractor and Tongue
Pushers Bishop with
Comfortable Margin,
160mm



SSI-D-075
Cheek Retractor
Retractor Combination
250mm

RETRACTORS

Ранорасширители
Ecarteurs
Wundhaken

Ранорозширювачі
Separadores
المنشآت



SSI-D-076
Cheek Retractor
Long



SSI-D-077
Cheek Retractor
Long



SSI-D-078
Cheek Retractor
Long



SSI-D-079
Unique Retractor
Length 175mm
angled 45°



SSI-D-080
Unique Retractor
Length 175mm
angled 90°



SSI-D-081
Retractor
160mm



SSI-D-082
Retractor
190mm



SSI-D-083
Mini-Langenbeck
Retractor
160mm, Hooks 22 mm



SSI-D-084
Cheek Retractor
Retractors Combination
210mm, 2 Pcs



SSI-D-085
Mini Retractor
About 80mm



SSI-D-086
Senn Miller Retractor
16cm Hooks 22 mm



SSI-D-087
75x75
Austin Tissue
Retractors



80mm
Available with
round tip on
request

130mm
Available with
round tip on
request

SSI-D-088
75x75
Austin Tissue
Retractors

RETRACTORS



- Ранорасширители
- Ecarteurs
- Wundhaken

- Ранорозширювачі
- Separadores
- الكاشطات



SSI-D-098 30x11 mm
SSI-D-099 30x16 mm
Langenbeck Retractor
210mm, hook

Middeldorpf Retractor
SSI-D-100 17 cm
SSI-D-101 22 cm

SSI-D-102
Farabeuf
(120 X 12mm)
Set of 2 Pcs

SSI-D-103
Seldin Retractor

SSI-D-104
Feldman
Retractor
140mm

PREMIUM QUALITY DENTAL INSTRUMENTS

- | | |
|----------------------|-----------------------|
| ■ Ножницы десневые | ■ Ножіці для ясен |
| ■ Ciseaux a gencives | ■ Tijeras para encias |
| ■ Zahnfleischscheren | ■ مقص صمغ |



SSI-D-105
Gum Scissors
120mm
Straight



SSI-D-106
Gum Scissors
120mm
Curved



SSI-D-107
Micro Iris
90mm
Straight



SSI-D-108
Micro Iris
90mm
Curved



SSI-D-109
Iris
115mm
Curved



SSI-D-110
Iris
110mm
Straight



SSI-D-111
Iris
110mm
Curved



SSI-D-112
Angular, Saw edge
115mm



SSI-D-113
Angular
115mm



Metzenbaum
SSI-D-114 140mm Straight
SSI-D-115 200mm Straight
SSI-D-116 140mm Curved
SSI-D-117 200mm Curved

■ Ножицы десневые
■ Ciseaux a gencives
■ Zahnfleischscheren

■ Ножиці для ясен
■ Tijeras para encias
■ مقص صغ



SSI-D-118
Goldman-Fox
130mm
Saw edge,
straight



SSI-D-119
Goldman-Fox
130mm
Saw edge,
curved



SSI-D-120
Goldman-Fox
130mm
Saw edge,
double curved



SSI-D-121
La Grange
115mm
Saw edge,
double curved



SSI-D-122
Neumann
120mm
Saw edge,
double curved



SSI-D-123
Kilner (Ragnell)
120mm
Straight



SSI-D-124
Kilner (Ragnell)
120mm
Curved



SSI-D-125
Joseph
140mm
Straight

■ Ножницы десневые
■ Ciseaux a gencives
■ Zahnfleischscheren

■ Ножіці для ясен
■ Tijeras para encias
■ مقص صغ



SSI-D-126
Joseph
140mm
Curved



SSI-D-127
Kelly
160mm
Straight



SSI-D-128
Kelly
160mm
Curved



SSI-D-129
Locklin
160mm
Saw edge,
angular



Locklin
SSI-D-130 120mm
SSI-D-131 160mm
Saw edge,
angular



SSI-D-132
Dean
170mm
Saw edge,
angular



Spencer
SSI-D-133 90mm
SSI-D-134 110mm



SSI-D-135
Spencer
130mm



SSI-D-136
Spencer
115mm



SSI-D-137
Straight
120mm

■ Ножицы десневые
■ Ciseaux a gencives
■ Zahnfleischscheren

■ Ножиці для ясен
■ Tijeras para encias
■ مقص صمغ



SSI-D-138
Straight
115mm



SSI-D-139
Curved
115mm



Straight
SSI-D-140 140mm
SSI-D-141 160mm
SSI-D-142 180mm



Mayo
SSI-D-143 140mm
SSI-D-144 200mm
Straight
SSI-D-145 140mm
SSI-D-146 200mm
Curved



Mayo
SSI-D-147 140mm
SSI-D-148 160mm
SSI-D-149 180mm
Straight
SSI-D-150 140mm
SSI-D-151 160mm
SSI-D-152 180mm
Curved



Standard Operating Scissors
Sharp/Sharp Straight
SSI-D-153 140 mm
SSI-D-154 160 mm
SSI-D-155 180 mm



Standard Operating Scissors
Sharp/Sharp Curved
SSI-D-156 140 mm
SSI-D-157 160 mm
SSI-D-158 180 mm

Ножницы десневые
Ciseaux a gencives
Zahnfleischscheren

Ножці для ясен
Tijeras para encias
مقص صغ



SSI-D-159
Noyes
110mm, Straight



SSI-D-160
Noyes
110mm
Curved



SSI-D-161
Noyes
110mm
Angular



SSI-D-162
Castroviejo
150mm
Curved



SSI-D-163
Westcott Scissors
11 cm



Westcott Scissors
Special Pattern
SSI-D-164 11cm Straight
SSI-D-165 11cm Curved



SSI-D-166
155mm



■ Ножницы для короны ■ Корональні ножиці
■ Ciseaux de couronne ■ Tijeras de la corona
■ Krone Schere ■ مقص التاج

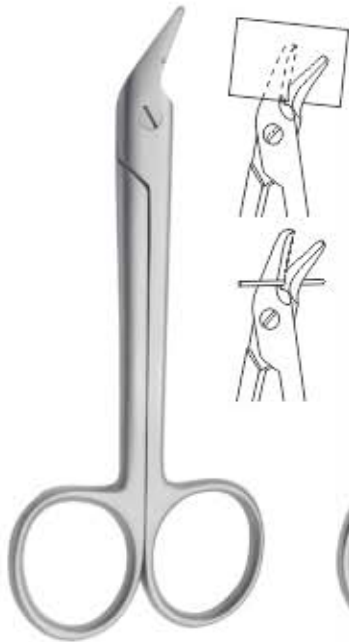

SSI-D-167
Universal
120mm
Saw edge



SSI-D-168
Beebee
110mm
Saw edge, straight



SSI-D-169
Beebee
110mm
Saw edge, curved



SSI-D-170
Beebee
120mm
Saw edge, straight



SSI-D-171
Beebee
120mm
Saw edge, curved



Lister Bandage Scissors
SSI-D-172 90mm
SSI-D-173 110mm
SSI-D-174 140mm
SSI-D-175 180mm
SSI-D-176 240mm



SSI-D-177
Dental scissors
large 175mm



SSI-D-178
180mm
universal
autoclavable up to
143 °C

Ножницы десневые
Ciseaux a gencives
Zahnfleischscheren

Ножіці для ясен
Tijeras para encias
مقص صغ

T.C GOLD



SSI-D-179
Iris
110mm
Straight



SSI-D-180
Iris
110mm
Curved



SSI-D-181
Goldman-Fox
130mm
Saw edge, straight



SSI-D-182
Goldman-Fox
130mm
Saw edge, Curved



SSI-D-183
Iris Double Bend
11cm



SSI-D-184
La Grange
115mm
Saw edge,
double Curved



Mayo
SSI-D-185 140mm
SSI-D-186 170mm
SSI-D-187 230mm
Straight



Mayo
SSI-D-188 140mm
SSI-D-189 170mm
SSI-D-190 230mm
Curved

■ Ножницы десневые
■ Ciseaux a gencives
■ Zahnfleischscheren

■ Ножіці для ясен
■ Tijeras para encias
■ مقص صغ

T.C GOLD



SSI-D-191
Dean Scissors TC
17cm curve



Metzenbaum
SSI-D-192 145mm
SSI-D-193 180mm
SSI-D-194 200mm
Straight



Metzenbaum
SSI-D-195 145mm
SSI-D-196 180mm
SSI-D-197 200mm
Curved



SSI-D-198
Kelly
160mm
Straight



SSI-D-199
Kelly
160mm
Curved



SSI-D-200
Universal
120mm



SSI-D-201
Beebee
110mm
Saw edge,
straight



SSI-D-202
Beebee
110mm
Saw edge,
curved



SSI-D-203
Beebee
120mm
Saw edge,
straight



SSI-D-204
Beebee
120mm
Saw edge,
curved

- | | |
|----------------------|-----------------------|
| ■ Ножницы десневые | ■ Ножіці для ясен |
| ■ Ciseaux a gencives | ■ Tijeras para encias |
| ■ Zahnfleischscheren | ■ مقص صغ |



SSI-D-205
Goldman Fox Scissors
12.5cm Curved



SSI-D-206
Iris Scissors
11.5cm Curved
Serrated For Slip-Free Cutting



SSI-D-207
LaGrange Scissors
11.5cm Double Curved
Serrated For Slip-Free Cutting

Double
Curved



SSI-D-208
Castroviejo Micro Scissors
12cm Curved



SSI-D-209
Super Cut Goldman Fox
13.2cm Curved
Serrated For Slip-Free Cutting



SSI-D-210
Super Cut Iris
11cm Straight
Serrated For Slip-Free Cutting



SSI-D-211
Super Cut Iris
11cm Curved
Serrated For Slip-Free Cutting





SSI-D-212
Super Cut LaGrange
11.5cm
Double Curved
Serrated For Slip-Free Cutting

Double
Curved

- | | |
|----------------------|-----------------------|
| ■ Ножницы десневые | ■ Ножці для ясен |
| ■ Ciseaux a gencives | ■ Tijeras para encias |
| ■ Zahnfleischscheren | ■ مقص صمغ |

T.C. / CERAMIC COATED SCISSORS

 <p>Mayo Dissecting Scissors</p>	 <p>SSI-D-213 14.5cm</p>	 <p>SSI-D-216 14.5cm</p>	 <p>Metzenbaum Standard Scissors</p>	 <p>SSI-D-219 14.5cm</p>	 <p>SSI-D-226 14.5cm</p>
	 <p>SSI-D-214 17cm</p>	 <p>SSI-D-217 17cm</p>		 <p>SSI-D-220 18cm</p>	 <p>SSI-D-227 18cm</p>
	 <p>SSI-D-215 23cm B/B, Str.</p>	 <p>SSI-D-218 23cm B/B, Cvd.</p>		 <p>SSI-D-221 20cm</p>	 <p>SSI-D-228 20cm</p>
				 <p>SSI-D-222 23cm</p>	 <p>SSI-D-229 23cm</p>
				 <p>SSI-D-223 26cm</p>	 <p>SSI-D-230 26cm</p>

 <p>Locklin Dissecting Scissors, S/S</p>	 <p>SSI-D-233 16cm 1 Blade Serrated</p>	 <p>Locklin Dissecting Scissors, S/S</p>	 <p>SSI-D-234 16cm 1 Blade Serrated</p>	 <p>Dean Dissecting Scissors, S/S</p>	 <p>SSI-D-235 17cm 1 Blade Serrated</p>

- Зажимы артериальные
- Затискачі артеріальні
- Pinces hemostatiques
- Pinzas hemostaticas
- Arterienklemmen
- ملقط هايموستاتيک



Hartmann (Baby Mosquito)
SSI-D-236 100mm straight
SSI-D-237 100mm curved



Halstead Mosquito
SSI-D-238 125mm straight
SSI-D-239 125mm curved



Halstead Mosquito 1x2
SSI-D-240 125mm straight
SSI-D-241 125mm Curved



Kelly
SSI-D-242 140mm straight
SSI-D-243 140mm curved



Rochester-Pean
SSI-D-244 140mm
SSI-D-245 160mm
SSI-D-246 180mm
SSI-D-247 200mm straight
SSI-D-248 140mm
SSI-D-249 160mm
SSI-D-250 180mm
SSI-D-251 200mm curved



Rochester-Kocher 1x2
SSI-D-252 140mm
SSI-D-253 160mm
SSI-D-254 180mm
SSI-D-255 200mm straight
SSI-D-256 140mm
SSI-D-257 160mm
SSI-D-258 180mm
SSI-D-259 200mm curved



Kelly-Rankin
SSI-D-260 160mm straight
SSI-D-261 160mm curved



SSI-D-262 Heiss
 200mm curved

■ Зажимы артериальные, зажимы для салфеток
■ Pincès hemostatiques, Pincès a compresses
■ Arterienklemmen, Tuschklemmen

■ Затискачі артеріальні, затискачі для серветок
■ Pinzas hemostaticas, Pincès para compressas
■ الملقط هايموستاتيک المشابك منشفة

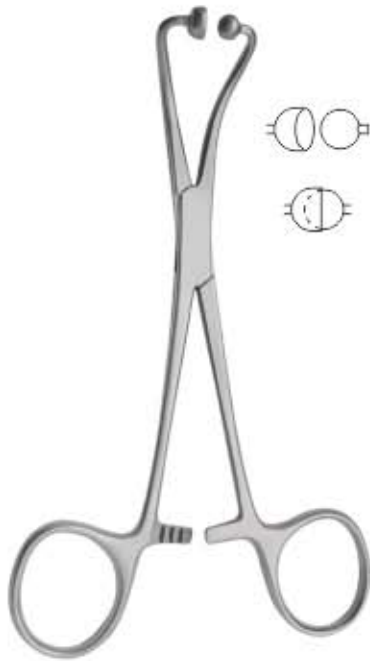

SSI-D-263
Backhaus
Not-perforating and not-damaging 140mm



SSI-D-264
Backhaus
130mm



SSI-D-265
Backhaus
85mm



SSI-D-266
Jones
90mm



SSI-D-267
Gross Maier
Dressing Forceps
200mm straight





SSI-D-269
Foerster
Dressing Forceps
200mm





SSI-D-270
Young
Tongue Forceps
170mm



SSI-D-271
Collins
Tongue Forceps
170mm

 **Стерилизационные и тканевые зажимы**
 **Stérilisation et pincés pour tissus**
 **Esterilizadores y sujetadores de tejidos**

 **Стерилізаційні та тканинні затискачі**
 **Esterilização e grampos de tecido**
 **تعطيم و المشابك الأنسجة**



Micro Masquito
Fig. 1
10 cm



SSI-D-272
Straight

SSI-D-273
Curved



Micro Masquito 1x2
Fig. 1
10 cm



SSI-D-274
Straight

SSI-D-275
Curved



Cheatie
SSI-D-276
270mm



Rogge
SSI-D-277 200mm
SSI-D-278 300mm



Lorna
SSI-D-279 100mm
SSI-D-280 130mm



SSI-D-281
Allis-Baby 3:4
150mm



SSI-D-282
Allis 4:5
200mm



SSI-D-283
Allis 6:7
200mm

Иглодержатели
Porte-aiguilles
Nadelhalter

Голкотримачи
Porta-agujas
اصحاب ابرة

T.C GOLD



Crile-Ryder T.C
SSI-D-284 130mm
SSI-D-285 150mm
SSI-D-286 180mm

SSI-D-287
Halsey
130mm

SSI-D-288
Baumgartner
130mm

SSI-D-289
Derf
120mm



SSI-D-290
Delicate
150mm

Mayo-Hegar
SSI-D-291 130mm
SSI-D-292 160mm
SSI-D-293 180mm
SSI-D-294 200mm

Crile-Wood
SSI-D-295 150mm
straight

Crile-Wood
SSI-D-296 150mm
curved

NEEDLE HOLDERS

Иглодержатели
Porte-aiguilles
Nadelhalter

Голкотримачи
Porta-agujas
اصحاب ابرة

T.C GOLD



Mathieu-Kocher

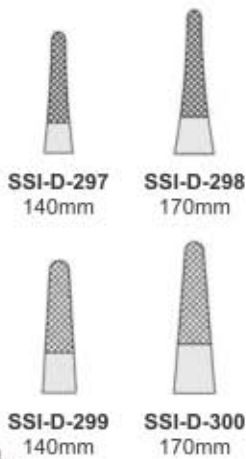

Mathieu

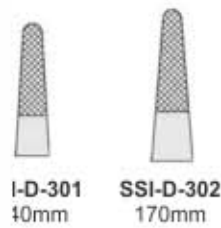

Castroviejo
Special Pattern
SSI-D-305
140mm
curved
SSI-D-306
180mm
curved

Castroviejo
Special Pattern
SSI-D-303 140mm straight
SSI-D-304 180mm straight



SSI-D-307
Olsen-Hegar Needle
Holder With Scissors
140mm



SSI-D-308
Gillies Needle
Holder With Scissors
160mm



Castroviejo
SSI-D-309 140mm straight
SSI-D-310 180mm straight
SSI-D-311 140mm curved
SSI-D-312 180mm curved



Castroviejo
SSI-D-313 140mm straight
SSI-D-314 180mm straight
SSI-D-315 140mm curved
SSI-D-316 180mm curved

NEEDLE HOLDERS

Иглодержатели
Porte-aiguilles
Nadelhalter

Голкотримачи
Porta-agujas
اصحاب ابرة



SSI-D-317
Lichtenberg-
Ryder T.C
14 cm



SSI-D-318
Lichtenberg-
Ryder T.C
14 cm



SSI-D-319
Lichtenberg-
Ryder T.C
17 cm



SSI-D-320
Lichtenberg-
Ryder T.C
17 cm



SSI-D-321
Barraquer
18 cm



SSI-D-322
Barraquer
18 cm



SSI-D-323
Barraquer T.C
18 cm



SSI-D-324
Barraquer T.C
18 cm



SSI-D-325
Tönnis
18 cm



SSI-D-326
Castroviejo
13 cm
Straight



SSI-D-327
Kalt Needle Holders T.C
14 cm Straight



SSI-D-328
Peet Splinter Forceps
11.5 cm

SSI-D-329
La Grange
Curved



SSI-D-330
All-Purpose Pliers



Иглодержатели
Porte-aiguilles
Nadelhalter

Голкотримачи
Porta-agujas
اصحاب ابرة



SSI-D-331 130mm
SSI-D-332 150mm
SSI-D-333 180mm

Castroviejo



SSI-D-334
Halsey
130mm



SSI-D-335
Baumgartner
130mm



SSI-D-336
Derf
120mm



SSI-D-337
Delicate
150mm



SSI-D-338
Adson
170mm



Mayo-Hegar
SSI-D-339 130mm
SSI-D-340 160mm
SSI-D-341 180mm
SSI-D-342 200mm



SSI-D-343
Crile-Wood
150mm

NEEDLE HOLDERS

Иглодержатели
Porte-aiguilles
Nadelhalter

Голкотримачи
Porta-agujas
اصحاب ابرة



SSI-D-344
Olsen-Hegar Needle
Holder With Scissors
140mm



SSI-D-345
Gillies Needle
Holder With Scissors
160mm



Mathieu



SSI-D-346
140mm



SSI-D-347
170mm



SSI-D-348
200mm



Mathieu-Kocher



SSI-D-349
140mm



SSI-D-350
170mm



SSI-D-351
Boynton
120mm

Инструменты для системы коффердам
Pinces porte-crampons a digue
Kofferdam Klammerzangen

Инструменти для системи коффердам
Pinzas de engrapar para dique de caucho
السداد المطاط الحافظ المشابك



SSI-D-352
Brewer



SSI-D-353
Stockes



SSI-D-354
Palmer



SSI-D-355
Ivory
light weight



SSI-D-356
Anisworth

Punch Plier



SSI-D-357
Ivory



SSI-D-358
Elastic
Seaparating & Ligature
Plier



SSI-D-359
Elastic
Seaparating & Ligature
Plier



SSI-D-360
Small
Rubber Dam Frame



SSI-D-361
Medium
Rubber Dam Frame



SSI-D-362
Large
Rubber Dam Frame

■ Резиновая дамба зажимы комплекты
■ Trousses de caoutchouc
■ Gummidammklammern

■ Гумова дамба затискачі комплекти
■ Conjuntos de abrazaderas de retención de caucho
■ المطاط لمد المشابك مجموعات



Rubber Dam Kits



SSI-D-363

On request the Content of the rubber dam kit can be changed with other instruments.

Content:

- 01 Anisworth
- 02 Brewer
- 03 Clamps Stand
- 04 Rubber Dam Frame L
- 05 Rubber Dam Frame M
- 06 Rubber Dam Box Lower Case
- 07 Rubber Dam Box Upper Case

- 08 Rubber Dam Clamp Fig. 212
- 09 Rubber Dam Clamp Fig. 211
- 10 Rubber Dam Clamp Fig. 8
- 11 Rubber Dam Clamp Fig. 8A
- 12 Rubber Dam Clamp Fig. 14
- 13 Rubber Dam Clamp Fig. 14A
- 14 Rubber Dam Clamp Fig. 0
- 15 Rubber Dam Clamp Fig. 00
- 16 Rubber Dam Clamp Fig. 2
- 17 Rubber Dam Clamp Fig. 2A
- 18 Rubber Dam Clamp Fig. 7

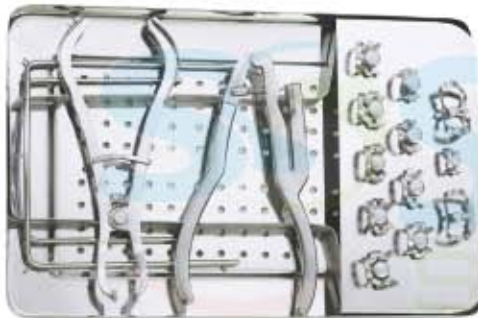

SSI-D-364

On request the Content of the rubber dam kit can be changed with other instruments.

Content:

- 01 Ivory
- 02 Ivory light weight
- 03 Clamps Stand
- 04 Rubber Dam Frame M
- 05 Rubber Dam Frame L
- 06 Rubber Dam Box Lower Case
- 07 Rubber Dam Box Upper Case

- 08 Rubber Dam Clamp Fig. 209
- 09 Rubber Dam Clamp Fig. 212
- 10 Rubber Dam Clamp Fig. 211
- 11 Rubber Dam Clamp Fig. 8
- 12 Rubber Dam Clamp Fig. 8A
- 13 Rubber Dam Clamp Fig. 14
- 14 Rubber Dam Clamp Fig. 14A
- 15 Rubber Dam Clamp Fig. 0
- 16 Rubber Dam Clamp Fig. 00
- 17 Rubber Dam Clamp Fig. 2
- 18 Rubber Dam Clamp Fig. 2A
- 19 Rubber Dam Clamp Fig. 7

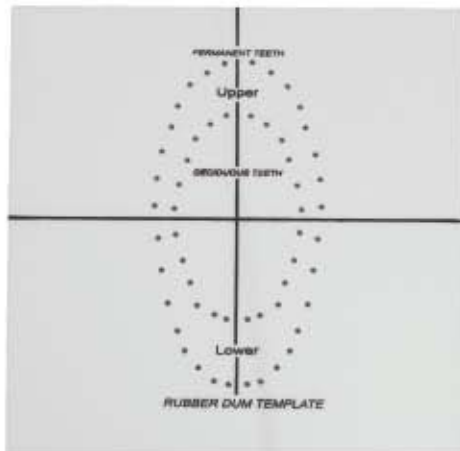

SSI-D-365
Rubber Dum Template

■ Резиновая дамба зажимы комплекты
■ Trousses de caoutchouc
■ Gummidammklammern

■ Гумова дамба затискачі комплекти
■ Conjuntos de abrazaderas de retención de caucho
■ المطاط السد المشابك مجموعات



SSI-D-366

Stainless Steel Gold Plated Rubber Dam Clamp Tray with 11 Different Clamps
Fig. 212, 211, 8, 8A, 14, 14A, 0, 00, 2, 2A, 7



SSI-D-367

Stainless Steel Rubber Dam Clamp Tray with 12 Different Clamps
Fig. 209, 212, 211, 8, 8A, 14, 14A, 0, 00, 2, 2A, 7



SSI-D-368

Stainless Steel Rubber Dam Clamp Tray with 8 Different Clamps
Fig. 1, 26, 29, 51, 60, 202, 205, 210



SSI-D-369

Stainless Steel Rubber Dam Clamp Tray
(without clamps)



For Special Packing Rubber Dam Kit Please Ask

SSI-D-370

Anisworth 17cm
Ivory 17cm
Brewer 17.5cm
Rubber Dam Frame (Children)
Rubber Dam Frame (Adult)
Ruber Dam Clamps 11 Pcs
Fig. 00, Fig.0, Fig.1, Fig.2A, Fig.3, Fig.7,
Fig.8, Fig.8A, Fig.9, Fig.212, Fig.14

Кламмера для коффердама
Crampons pour digue
Kofferdam Klammern

Кламмера для коффердама
Grapas para dique de caucho
المشابك المد المطاط



SSI-D-371
Fig. 15



SSI-D-372
Fig. 18



SSI-D-373
Fig. 24



SSI-D-374
Fig. 25



SSI-D-375
Fig. 26



SSI-D-376
Fig. 28



SSI-D-377
Fig. 30



SSI-D-378
Fig. 31



SSI-D-379
Fig. 51



SSI-D-380
Fig. 138



SSI-D-381
Fig. 139



SSI-D-382
Fig. 200



SSI-D-383
Fig. 201



SSI-D-384
Fig. 202



SSI-D-385
Fig. 203



SSI-D-386
Fig. 204



SSI-D-387
Fig. 205



SSI-D-388
Fig. 3



SSI-D-389
Fig. W3



SSI-D-390
Fig. 4



SSI-D-391
Fig. 56A



SSI-D-392
Fig. 7



SSI-D-393
Fig. 7A



SSI-D-394
Fig. 8



SSI-D-395
Fig. 8A



SSI-D-396
Fig. W8A



SSI-D-397
Fig. 10



SSI-D-398
Fig. 11



SSI-D-399
Fig. 12A



SSI-D-400
Fig. 13A



SSI-D-401
Fig. 14



SSI-D-402
Fig. 14A



SSI-D-403
Fig. 14AN



SSI-D-404
Fig. 22



SSI-D-405
Fig. 27



SSI-D-406
Fig. 207



SSI-D-407
Fig. 29



SSI-D-408
Fig. 206



SSI-D-409
Fig. 208



SSI-D-410
Fig. 209



SSI-D-411
Fig. 1



SSI-D-412
Fig. 1A



SSI-D-413
Fig. 2



SSI-D-414
Fig. 2A



SSI-D-415
Fig. W2A



SSI-D-416
Fig. 0



SSI-D-417
Fig. 00



SSI-D-418
Fig. 210



SSI-D-419
Fig. 211



SSI-D-420
Fig. 212



SSI-D-421
Fig. 6



SSI-D-422
Fig. 9



SSI-D-423
Fig. N06



SSI-D-424
Fig. U67



SSI-D-425
Fig. P1



SSI-D-426
Fig. P2



SSI-D-427
Fig. G-1



SSI-D-428
Fig. G-2

Инструменты для удаления коронок
Arrache-couronnes
Teleskopkronenzangen

Инструменты для видаления коронок
Arranca-corona
مزيات التاج

Complete With 3 Attachment



SSI-D-429
Wynman Crown Gripper
No Lock T.C 16 cm



SSI-D-430



A



B



C



SSI-D-431
Crown Spreader, Crown Remover
Special Instrument for crown spreading
after separating, simple and safe
operation.



SSI-D-432
Crown Remover



A



B



SSI-D-433
Fig. 7



SSI-D-434
Fig. 8



SSI-D-435
Fig. 9



SSI-D-436
Fig. 10

For Molars and Premolars



SSI-D-437
Fig. 11



SSI-D-438
Fig. 12



SSI-D-439
Fig. 13
Tofflemire

CROWN REMOVER

■ Инструменты для удаления коронок
■ Arrache-couronnes
■ Teleskopkronenzangen

■ Инструменти для видалення коронок
■ Arranca-corona
■ مزيلات التاج



SSI-D-440
Crown Spreaders



SSI-D-441
Crown Spreaders
with Spring



SSI-D-442
Crown Spreader



SSI-D-443
Fig. 1



SSI-D-444
Fig. 2



SSI-D-445
Crown Spreaders
Fig. 3



SSI-D-446
Crown Remover



SSI-D-447
Crown Remover



SSI-D-448
Crown Remover

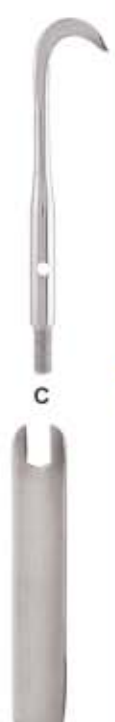

E

Прочие товары
Divers produits et services
Sonstige Produkte

Інші товари
Varios Productos
المنتجات المتنوعة



SSI-D-449
X Ray Film Hanger



SSI-D-450
X Ray Film Hanger



SSI-D-451
X Ray Film Hanger



SSI-D-452
X Ray Film Hanger



SSI-D-453
Napkin Holder with
Plastic Chain



SSI-D-454
Napkin holder with metal chain



SSI-D-455
Mouth Props
Small

SSI-D-456
Mouth Props
Medium

SSI-D-457
Mouth Props
Large

Key Rings



SSI-D-458



SSI-D-459



SSI-D-460



SSI-D-461



SSI-D-462



SSI-D-463

- | | |
|--------------------|---------------------|
| ■ Матрицедержатели | ■ Матрицеутримувачи |
| ■ Porte Matrices | ■ Porta Matrices |
| ■ Matrizenspanner | ■ مصفوفة الخدم |



SSI-D-464
Fig. 5
Ivory 8
5 mm



SSI-D-465
Fig. 6
Ivory 8
6 cm



SSI-D-466
Fig. 7
Ivory 8
7 cm



SSI-D-467
Ivory 8 N



SSI-D-468
Didner 8 P



SSI-D-469
Fig. 1
Tofflemire-Universal



SSI-D-470
Fig. 2
Tofflemire-Junior



SSI-D-471
Fig. 3
Tofflemire-Senior



Amalgam Well



SSI-D-472
Stainless Steel
Amalgam Well
Medium



SSI-D-473
Stainless Steel
Amalgam Well
large

 Матрицедержатели
 Porte Matrices
 Matrizenspanner

 Матрицеутримувачи
 Porta Matrices
 مصفوفة الخدم



SSI-D-474
Tofflemire-Junior
45 mm



SSI-D-475
Tofflemire-Universal
60 mm



SSI-D-476
Matrix Ivory 8
6 mm



SSI-D-477
Didner 8 P
70 mm



SSI-D-478
Nyström
Left



SSI-D-479
Nyström
Right



SSI-D-480
Narrow



SSI-D-481
Wide



SSI-D-482
Ivory
with shields



SSI-D-483
Ivory
without shields



SSI-D-484
Ivory



SSI-D-485
Elliot

■ Инструменты для амальгамы ■ Инструменти для амальгами
■ Instruments pour amalgame ■ Instrumentos para amalgama
■ Amalgamisinstrumente ■ الصكوك الملقم



SSI-D-486
Fig. 10
165mm
English pattern



SSI-D-487
Fig. 1
185mm
German pattern



SSI-D-488
Fig. 1
150mm
Swiss pattern



SSI-D-489
Fig. 1
150mm



SSI-D-490
Fig. 2
150mm, 45°



SSI-D-491
Fig. 3
140mm, 90°



SSI-D-492
Chip Blower



SSI-D-493



SSI-D-494



SSI-D-495



SSI-D-496
Water Syringe

PREMIUM QUALITY DENTAL INSTRUMENTS

■ Инструменты для амальгамы ■ Инструменти для амальгами
■ Instruments pour amalgame ■ Instrumentos para amalgama
■ Amalgamis/instrumente ■ الصكوك للعقم

AMALGAM CARRIERS

TIP SIZES FOR DISTAL OR SINGLE-END

1.5 mm

2.0 mm

2.8 mm

1.5 mm

2.0 mm



SSI-D-498
Mini/
Single-End



SSI-D-499
Regular
Single-End



SSI-D-500
Large
Single-End



SSI-D-501
Mini
Distal



SSI-D-502
Regular
Distal

TIP SIZES FOR DOUBLE-END

1.5 mm

2.8 mm

3.2 mm



2.0 mm
SSI-D-503
Mini/
Regular



2.0 mm
SSI-D-504
Large/
Regular



2.0 mm
SSI-D-505
Jumbo/
Regular



SSI-D-506
Amalgam
Well

TIP SIZES FOR DOUBLE-END



SSI-D-507 - 1.5mm-2.0mm **SSI-D-510** - 1.0mm-2mm
SSI-D-508 - 2.0mm-2.8mm **SSI-D-511** - 2.0mm-3mm
SSI-D-509 - 2.0mm-3.2mm **SSI-D-512** - 2.0mm-4mm



SSI-D-513 - 1.5mm-2.0mm **SSI-D-516** - 1.0mm-2mm
SSI-D-514 - 2.0mm-2.8mm **SSI-D-517** - 2.0mm-3mm
SSI-D-515 - 2.0mm-3.2mm **SSI-D-518** - 2.0mm-4mm



SSI-D-519 - 1.5mm-2.0mm **SSI-D-522** - 1.0mm-2mm
SSI-D-520 - 2.0mm-2.8mm **SSI-D-523** - 2.0mm-3mm
SSI-D-521 - 2.0mm-3.2mm **SSI-D-524** - 2.0mm-4mm



SSI-D-525 - 1.5mm-2.0mm **SSI-D-528** - 1.0mm-2mm
SSI-D-526 - 2.0mm-2.8mm **SSI-D-529** - 2.0mm-3mm
SSI-D-527 - 2.0mm-3.2mm **SSI-D-530** - 2.0mm-4mm



SSI-D-531 - 1.5mm
SSI-D-532 - 2.0mm
SSI-D-533 - 2.0mm
SSI-D-534 - 3.0mm



SSI-D-497
Single-End

ROOT PLANNING CHISELES & BONE FILES

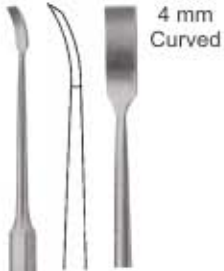

4 mm
Curved



4 mm
6 mm



SSI-D-535
Freer
160mm



SSI-D-536
Freer
160mm



SSI-D-537
Krarner-Nevins
Bone Chisel



SSI-D-538
Krarner-Nevins
Bone Chisel



SSI-D-539
Miller



SSI-D-540
Miller

BONE FILES



SSI-D-541
Miller 21



SSI-D-542
Miller 1X
cross cut



SSI-D-543
Miller 2X
cross cut



SSI-D-544
Miller 52



SSI-D-545
Wahl 1



Williger
Curette
13.5 cm

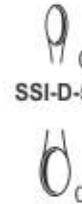

SSI-D-546

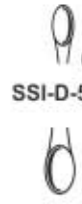

SSI-D-547



SSI-D-548



CHISELS



SSI-D-549 SSI-D-550 SSI-D-551 SSI-D-552



SSI-D-553
4mm
(Straight)



SSI-D-554
4mm
(Curved)



SSI-D-555
6mm
(Straight)



SSI-D-556
6mm
(Curved)

Periodontal Chisels

Bone Splitting Chisels

2.0mm



SSI-D-557

2.5mm



SSI-D-558

3.0mm



SSI-D-559

3.5mm



SSI-D-560

4.0mm



SSI-D-561

4.5mm



SSI-D-562

5.0mm



SSI-D-563

Инструменты пародонтологические
Instruments pour la parodontologie
Instrumente für die Parodontologie

Инструменти пародонтологічні
Instrumentos para periodoncia
الصكوك اللثة



SSI-D-564
1
Ochsenbin



SSI-D-565
2
Ochsenbin



SSI-D-566
Wakefield 1W
170mm



SSI-D-567
Wakefield 2W
170mm



SSI-D-568
Mead
190 mm

ø 28 mm
Teflon
interchangeable
inserts
Autoclavable.



SSI-D-569
Mead
170 mm

ø 26 mm
With
interchangeable
inserts
320 gr – 11 ¼ oz



SSI-D-570
Partson
180mm

ø 22 mm
Lead filled
200 gr – 7 oz



SSI-D-571
Vickers
19 cm



SSI-D-572
Herbert
19 cm



Partsch 140 mm
SSI-D-573 3mm
SSI-D-574 4mm
SSI-D-575 5mm
SSI-D-576 6mm

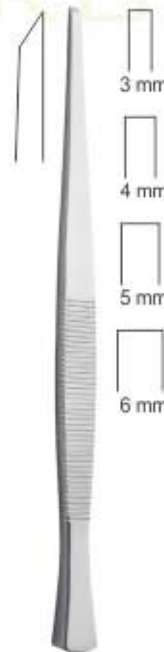

Partsch 170 mm
SSI-D-577 3mm
SSI-D-578 4mm
SSI-D-579 5mm
SSI-D-580 6mm



Partsch 140 mm
SSI-D-581 3mm
SSI-D-582 4mm
SSI-D-583 5mm
SSI-D-584 6mm



Partsch 170 mm
SSI-D-585 3mm
SSI-D-586 4mm
SSI-D-587 5mm
SSI-D-588 6mm

Инструменты пародонтологические
Instruments pour la parodontologie
Instrumente für die Parodontologie

Инструменти пародонтологічні
Instrumentos para periodoncia
الصنوك اللثة

PERIOSTEEL ELEVATORS



SSI-D-589
Buser



SSI-D-590
Ohl 10



SSI-D-591
Howard 9H



SSI-D-592
Allen 9A



SSI-D-593
Prichard 3



SSI-D-594
Seldin 23



SSI-D-595



SSI-D-596
Raspator, Raspatory
Length 175mm



SSI-D-597



SSI-D-598



SSI-D-599
Raspator, Williger
Length 170mm, different widths
(4mm, 5mm or 7mm)



SSI-D-600



SSI-D-601
Trelat
140mm

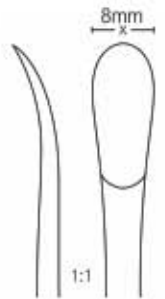

Инструменты пародонтологические
Instruments pour la parodontologie
Instrumente für die Parodontologie

Инструменти пародонтологічні
Instrumentos para periodoncia
الصكوك اللثة



SSSI-D-602
Freer



SSSI-D-603
Freer 15



SSSI-D-604
Freer 16



SSSI-D-605
Goldman-Fox
14



SSSI-D-606
P 24G



SSSI-D-607
Molt
175mm



SSSI-D-608
Molt
175mm





SSSI-D-609
Meat
175mm





SSSI-D-610
Meat
175mm



SSSI-D-611
Meat
175mm

 Шприцы стоматологические карпульные
 Seringues à usage dentaire
 Dentalspritzen

 Шприці стоматологічні карпульні
 Jeringas dentales
 المحاقن الأسنان



Type A
SSI-D-612 1.8ml
SSI-D-613 2.2ml



Type C
SSI-D-614 1.8ml
SSI-D-615 2.2ml



Type C
SSI-D-616 1.8ml
SSI-D-617 2.2ml



Type Euro
SSI-D-618 1.8ml
SSI-D-619 2.2ml



3-Ring
SSI-D-620 1.8ml
SSI-D-621 2.2ml



2-Ring
SSI-D-622 1.8ml
SSI-D-623 2.2ml



Euro
Breech loading
SSI-D-624 1.8ml
SSI-D-625 2.2ml



Euro
Breech loading
SSI-D-626 1.8ml
SSI-D-627 2.2ml



Manual Aspirating Syringe
SSI-D-628 1.8ml
SSI-D-629 2.2ml



Quatro
SSI-D-630 1.8ml
SSI-D-631 2.2ml



Trio
SSI-D-632 1.8ml
SSI-D-633 2.2ml



SSI-D-634 1.8ml
SSI-D-635 2.2ml
Dental Syringes With Silicon Handle
Available in Different Colors

■ Шприцы стоматологические карпульные
■ Seringues à usage dentaire
■ Dentspritzen

■ Шприці стоматологічні карпульні
■ Jeringas dentales
■ المحاقن الأسنان

For Special Packing of Dental Syringe Please Ask



SSI-D-636
Intraligamentary Syringe
1.8 ml



SSI-D-637
Intraligamentary Syringe
2.2 ml



SSI-D-638
Dental Syringe
1.8 ml



SSI-D-639
Dental Syringe
2.2 ml



SSI-D-640
Dental Syringe
1.8 ml



SSI-D-641
Dental Syringe
2.2 ml



SSI-D-642
Intraligamentary Syringe
1.8 ml



SSI-D-643
Intraligamentary Syringe
2.2 ml

Шприцы стоматологические карпульные
Seringues à usage dentaire
Dentalspritzen

Шприці стоматологічні карпульні
Jeringas dentales
المحاقن الأسنان



SSI-D-644 1.8ml.
SSI-D-645 2.2ml.
Pistol-Ject
injects 0.20ml with every click
Lever action for high injection pressure

Autoclavable



SSI-D-646 1.8ml
SSI-D-647 2.2ml
Fig. 1001
Intraligamental
Anesthesia Syringe in
Black Colour Auto
Cleavable

Autoclavable



Ject Ultima
SSI-D-648 1.8ml
SSI-D-649 2.2ml
Injects 0,05 ml with every click
Supplied with angled and straight tubes



Swedish Type
SSI-D-650 1.8ml
SSI-D-651 2.2ml



Ject angled
SSI-D-652 1.8ml
SSI-D-653 2.2ml



Ject straight
SSI-D-654 1.8ml
SSI-D-655 2.2ml



Disc System
SSI-D-656 1.8ml
SSI-D-657 2.2ml



Disc System
SSI-D-658 1.8ml
SSI-D-659 2.2ml





Disc System
SSI-D-660 1.8ml
SSI-D-661 2.2ml



Projection System
SSI-D-662 1.8ml
SSI-D-663 2.2ml



Projection System
SSI-D-664 1.8ml
SSI-D-665 2.2ml

 Шприцы стоматологические карпульные
 Seringues à usage dentaire
 Dentalspritzen

 Шприці стоматологічні карпульні
 Jeringas dentales
 المحاقن الأسنان

1. High Quality Aluminum
2. High Quality Anodizing Colours
3. Sterilized Autoclave At 134 C
4. Rust Proof



Aluminium - Dark
SSI-D-666 1.8 ml
SSI-D-667 2.2 ml



Aluminium - Silver
SSI-D-668 1.8 ml
SSI-D-669 2.2 ml



Aluminium - Orange
SSI-D-670 1.8 ml
SSI-D-671 2.2 ml



Aluminium - Green
SSI-D-672 1.8 ml
SSI-D-673 2.2 ml



Aluminium - Blue
SSI-D-674 1.8 ml
SSI-D-675 2.2 ml

Костные кусачки
Hohlmeißelzangen
Pincès-gouges

Кусачки для кісток
Pinzas-gubias
روتچوپرس العظام



SSI-D-676
Blumenthal
155 mm



SSI-D-677
Blumenthal 45°
150 mm



SSI-D-678
Blumenthal 90°
140 mm





SSI-D-679
Micro Luer
150 mm



SSI-D-680
Luer
150 mm



-  3 x 3 **SSI-D-681/1**
-  4 x 4 **SSI-D-681/2**
-  5 x 5 **SSI-D-681/3**

Kerrison

- | | |
|--|--|
|  Костные кусачки |  Кусачки для кисток |
|  Hohlmeißelzangen |  Pinzas-gubias |
|  Pincès-gouges |  روتجورس العظام |



SSI-D-682
Friedman
140 mm

SSI-D-683
Cleveland 4
140 mm

SSI-D-684
Micro Friedman
145 mm

SSI-D-685
Micro Friedman 90°
145 mm



SSI-D-686
Lempert Delicate
160 mm

SSI-D-687
Cleveland
155 mm

SSI-D-688
Beyer
170 mm

BONE ROUNGER

- Костные кусачки
- Кусачки для кісток
- Hohlmeißelzangen
- Pinzas-gubias
- Pincès-gouges
- روتچپورس العظام



SSI-D-689
Fig. 40
Ruskin

SSI-D-690
Fig. 41
Beyer

SSI-D-691
Fig. 50
Liston
140mm

SSI-D-692
Fig. 51
Liston
190mm

Cohen Tissue Nipper
SSI-D-693 100mm
SSI-D-694 140mm



SSI-D-695
Punch

SSI-D-696
Tomati
120mm

■ Инструменты для удаления коронок
■ Arrache-couronnes
■ Teleskopkronenzangen

■ Инструменты для видалення коронок
■ Arranca-corona
■ مزيلات التاج



SSI-D-697
160 mm

Crown Plier with plastic inserts Straight
For ceramical and plastic crowns and bridges, with plastic inserts (sterilization up to 180° C).



SSI-D-698
145 mm

Crown Plier with plastic inserts Angled



SSI-D-699
140 mm

Universal plier for the removal of ceramic crowns and bridges



SSI-D-700
140 mm

Universal plier for the removal of ceramic crowns and bridges



SSI-D-701
Furrer
Copper Ring
Removing Plier.
150 mm
Curved



SSI-D-702 125 mm
SSI-D-703 150 mm
Böhm
Pliers for telescope crowns.
Diamond points coated.



SSI-D-704
Nerve-Canal Pliers
straight



SSI-D-705
Nerve-Canal Pliers
Curved



SSI-D-706
Metal tip
220 mm
Hammer With Wooden Handle



SSI-D-707
Metal tip
220 mm



SSI-D-708
1
For plaster



SSI-D-709
2
For metal



SSI-D-710
Fret saw
250 mm



SSI-D-711
Small
Saw Blades



SSI-D-712
Large
Saw Blades



SSI-D-713
Ceri Saw



SSI-D-714
Plaster Shears
200 mm



Crucible Tongs
SSI-D-715 250 mm
SSI-D-716 320 mm



SSI-D-717
Ceri Saw
180 mm



SSI-D-718
Blade
0,12x5 mm
Conf. 12 pcs



SSI-D-719
Blade
0,25x5 mm
Conf. 12 pcs



SSI-D-720
Blade
0,25x3 mm
Conf. 12 pcs



Protecting Your
Smile



orthodontics pliers in Clinical Dentistry Orthodontics and Dentofacial Orthopaedics

Driven by the demand for tooth alignment, general practitioners are increasingly being asked to provide orthodontic treatment.

Dentists keen to participate in this area of expertise need to demonstrate the skills to identify suitable patients, the ability to provide conventional and contemporary orthodontic treatment and be aware of its limitations.

This is exactly what this programme delivers, along with the vital core competencies to excel in this unique postgraduate area.

The objective of the Orthodontics and Dentofacial Orthopaedics is to provide dental surgeons with the core knowledge and clinical skills essential for the delivery of competent, high-quality dental care.

It encompasses a blended learning approach and consists of a combination of lectures, seminars, workshops, clinical case discussions and laboratory sessions.

The flexible modular structure enables the programme to meet a wide range of student needs.

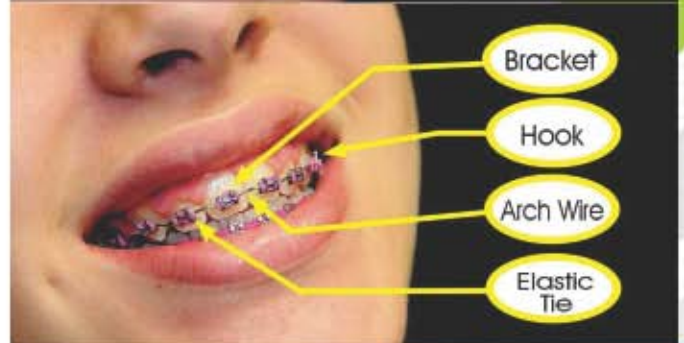

Bracket

Hook

Arch Wire

Elastic Tie



Инструменты ортодонтические
Instrumentos Ortodonticos
Orthodontische Instrumente

Инструменти ортодонтични
Instruments Orthodontiques
ادوات تقويم الأسنان



SSI-E-001
Height Gauge 0.18
Aluminum



SSI-E-002
Height Gauge 0.22
Aluminum



SSI-E-003
Height Gauge 0.18
Stainless Steel



SSI-E-004
Height Gauge 0.22
Stainless Steel



SSI-E-005
Moveable
Height Gauge



SSI-E-006
Bone Bracket Gauge



SSI-E-007
Endo Finger
Ruler Span
Measure Scale



SSI-E-008
Endo Finger
Ruler Span
Measure Scale



SSI-E-009
Endo Finger
Ruler Span
Measure Scale



SSI-E-010
Bone Thickness Gauge
40mm, 180mm



SSI-E-011
Osteometer
Measuring Forceps For Jaw
Ridge Width measurement, scale
on both sides, rustfree, autoclaviv



SSI-E-012
Positive
Postioner



SSI-E-013
Strip Saw



SSI-E-014
Compasso
De Willis



SSI-E-015
Endo Finger Ruler
Span Measure Scale



SSI-E-016
Endo Finger Ruler
Span Measure Scale

Инструменты ортодонтические
Instrumentos Ortodonticos
Orthodontische Instrumente

Инструменти ортодонтични
Instruments Orthodontiques
ادوات تقويم الأسنان

Bracket Holder Tweezers



SSI-E-017
Deluxe Bracket
Holder Tweezers



SSI-E-018
Deluxe Bracket
Holder Tweezers



SSI-E-019
Direct Bond Bracket
Holder Tweezers



SSI-E-020
Bracket Tweezers
Slot Aligner



SSI-E-021
Direct Bond
Bracket Holder
Tweezers, Small Tip



SSI-E-022
Exact Bracket
Holder Tweezers



SSI-E-023
Bracket Placing
Tweezers



SSI-E-024
Easy Access
Tweezers



SSI-E-025
Bracket Placer
Tweezers
(Extra Fine Tip)



SSI-E-026
Deluxe Bracket
Holder Tweezers
135mm



SSI-E-027
Easy Eccess
Tweezers



SSI-E-028
Slipper
Tweezers



SSI-E-029
Direct Bonding
Bracket Holders
135mm



SSI-E-030
Direct Bonding
Bracket Holders
136mm



SSI-E-031
Direct Bonding
Bracket Holders
135mm



SSI-E-032
Deluxe Bracket
Holder



SSI-E-033
Direct Bonding
Bracket Holders
140mm

Инструменты ортодонтические
Instrumentos Ortodonticos
Orthodontische Instrumente

Инструменти ортодонтични
Instruments Orthodontiques
أدوات تقويم الأسنان



SSI-E-034
Elastic instruments



SSI-E-035
Twiel-on elastic module instrument



SSI-E-036
Schure Band Seater



SSI-E-037
Ortho light scaler



SSI-E-038
Ortho light scaler



SSI-E-039
Ortho instrument



SSI-E-040
Ortho instrument



SSI-E-041
Ligature instruments



SSI-E-042
Ligature instruments

Инструменты ортодонтические
Instrumentos Ortodonticos
Orthodontische Instrumente

Инструменти ортодонтични
Instruments Orthodontiques
ادوات تقويم الأسنان



SSI-E-043
Ortho Light double ended
ligature director



SSI-E-044
Ortho Light double ended ligature scaler director tivate coil spring
are remove modules with one instruments



SSI-E-045
Ortho band pusher scaler



SSI-E-046
Ortho ligature director single ended



SSI-E-047
Ortho Light double ended ligature scaler/director
tivate coil spring are remove modules with one instruments



SSI-E-048
Ortholite Ligature Director Scaler



SSI-E-049
Ortho light ligature director double ended



SSI-E-050
Double ended Tampers

Инструменты ортодонтические
Instrumentos Ortodonticos
Orthodontische Instrumente

Инструменти ортодонтични
Instruments Orthodontiques
أدوات تقويم الأسنان



SSI-E-051
Band seater
auto cleavable



SSI-E-052
Band seater
auto cleavable
Triangle Shape



SSI-E-053
Band seater
auto cleavable
Square Shape



SSI-E-054
Band seater
auto cleavable
Round Shape



SSI-E-055
Mershon Band
Pusher
140mm



SSI-E-056
Band seating &
removing
instruments



SSI-E-057
Ortho Light double
ended
ligature director
scaler



SSI-E-058
Ortho Light Band
Pusher Scaler



SSI-E-059
Band Seating &
Removing
Silicon Grip



SSI-E-060
Ligature Instrument
Silicon Grip



SSI-E-061
Elastic Instrument
Silicon Grip

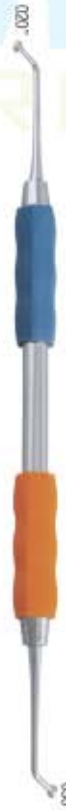

SSI-E-062
Distal Bender
Silicon Grip



SSI-E-063
Distal Bender
Silicon Grip



SSI-E-064
Distal Bender
Silicon Grip

Щипцы для ортодонтии и протезирования Щипці для ортодонтії та протезування
Pinces pour l'orthodontie et la prothèse Alicates para ortodoncia y prótesis
Zangen für Kieferorthopädie und Prothetik كمانشة لتكوين الأسنان بروتثیتیس



SSSI-E-065
Aderer
Large wire bending
and loop forming pliers
130mm

SSSI-E-066
Aderer Plier
For the manufacturing of appliances and
activation of wires for wires up to .030" fine
tip and up to .036" mean tip.
Length 130mm

SSSI-E-067
Angle Plier
Fig. 1
135mm



SSSI-E-068
Angle Plier
Fig. 2
140mm

SSSI-E-069
Angle Plier
Fig. 3
130mm

SSSI-E-070
Angle Plier
Fig. 4
140mm

Щипцы для ортодонтии и протезирования Щипці для ортодонтії та протезування
 Pincés pour l'orthodontie et la prothèse Alicates para ortodoncia y prótesis
 Zangen für Kieferorthopädie und Prothetik كمانة لتقويم الأسنان بروستیتیس



SSI-E-071
Adams Plier
 Adams pliers for bending wire arches and bends right angles for wires up to .022", .025 tip to beak. Length 130mm

SSI-E-072
Flat Nose Pliers
 140mm

SSI-E-073
Johnson Contouring Pliers
 140mm



SSI-E-074
Falcon Beak Contouring Pliers.
 130mm

SSI-E-075
How Plier
 Universally usable tool for the multiband technology for wires up to .028". Length 145mm

SSI-E-076
How Plier curved
 Universally usable tool for the multiband technology for wires up to .028". Length 145mm

Щипцы для ортодонтии и протезирования Щипці для ортодонтії та протезування
Pinces pour l'orthodontie et la prothèse Alicates para ortodoncia y prótesis
Zangen für Kieferorthopädie und Prothetik کمانچه لتقویم الاسنان بروسیتیکس



SSI-E-077
De La Rosa
Fig. 1
135mm



SSI-E-078
Arch Counting Plier Grooved
for double back and triple back
bands in 0.30" / 0.76mm & 0.36"
/ 0.91mm lingual arch wires
135mm



SSI-E-079
Contouring Plier
Fig. 2
135mm

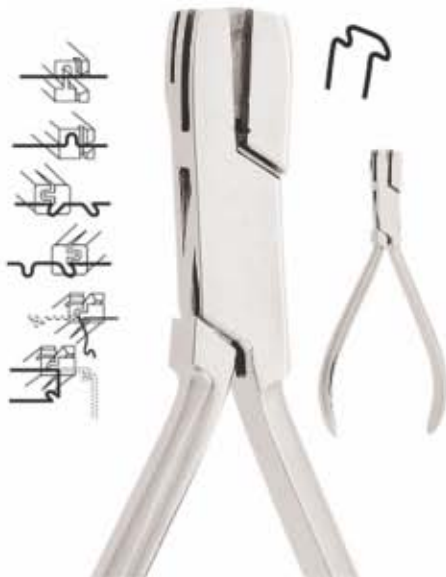

SSI-E-080
Nance Pliers
135mm



SSI-E-081
Tweed Loop
forming Pliers
140mm



SSI-E-082
Nance Loop
forming Pliers
140mm

■ Щипцы для ортодонтии и протезирования ■ Щипці для ортодонтії та протезування
■ Pincès pour l'orthodontie et la prothèse ■ Alicates para ortodoncia y prótesis
■ Zangen für Kieferorthopädie und Prothetik ■ كمانة لتقويم الأسنان بروستتیس



SSI-E-083
Tweed Loop Plier
130mm



SSI-E-084
Band Removing Plier
The curved blade of the band removing plier can strip easily and gently remove directly to the tooth. Length 140mm



SSI-E-085
Crown & Shell Plier
130mm



SSI-E-086
Young Wire Bending &
Loop Forming Pliers
135mm



SSI-E-087
Ligature Cutters T.C
Hard Wire
130mm



SSI-E-088
Mini Ligature Cutters T.C
Light Tip
130mm

Щипцы для ортодонтии и протезирования Щипці для ортодонтії та протезування
Pinces pour l'orthodontie et la prothèse Alicates para ortodoncia y prótesis
Zangen für Kieferorthopädie und Prothetik كمانشة لتكوين الأسنان بروتستيتيس



SSI-E-089
Mini Ligature cutters T.C
fine tip
130mm

SSI-E-090
Large
Fluch-cut distal and cutting Pliers T.C
with safety hold fitted with
un-breakable, corrosion
resistant and durable
stainless steel tips
130mm

SSI-E-091
Small
Fluch-cut distal and cutting Pliers T.C
with safety hold fitted with
un-breakable, corrosion
resistant and durable
stainless steel tips
130mm



SSI-E-092
Bracket Removing Plier
Bracket removing plier for comfortable
and quick removal of the brackets.
Length 135mm

SSI-E-093
Bracket Removing Plier curved
Bracket Removing Plier curved for
easy removal of brackets in the
posterior region. Length 145mm

SSI-E-094
Grooved Fine Plier
145mm

Щипцы для ортодонтии и протезирования Щипці для ортодонтії та протезування
 Pincés pour l'orthodontie et la prothèse Alicates para ortodoncia y prótesis
 Zangen für Kieferorthopädie und Prothetik كمانة لتقويم الأسنان بروستتیس



SSI-E-095
Aderer
Facebow loop forming Pliers
145mm



SSI-E-096
V Bending Pliers
135mm



SSI-E-097
Tweed / angle rectangular
arch forming & Torquing pliers
135mm



SSI-E-098
Weingart Plier medium
Weingart plier that are ideal due to
their curved tip for setting sheets and
is capable of bending the ends.
Length 145mm



SSI-E-099
Universal Plier
165mm



SSI-E-100
Jarabak Plier
145mm

Щипцы для ортодонтии и протезирования Щипці для ортодонтії та протезування
Pinces pour l'orthodontie et la prothèse Alicates para ortodoncia y prótesis
Zangen für Kieferorthopädie und Prothetik كمانشة لتكوين الأسنان بروستھتیس



SSI-E-101
Waldsachs Wire Bending
and Cutting Pliers
150mm



SSI-E-102
Universal Dolphin Style
Wire Bending & cutting pliers



SSI-E-103
Arrow Clasp Forming Pliers
125mm, 5"

SSI-E-104
Schwarz
130mm



SSI-E-105
Flat Nose Pliers
both sides smooth
140mm



SSI-E-106
Flat Nose Pliers
both sides serrated
140mm



SSI-E-107
Peeso
Wire Bending Pliers
135mm



SSI-E-108
Goslee
Flat Nose Pliers
140mm



SSI-E-109
Flat Nose Pliers
both sides serrated
with TC 140mm inserts



PREMIUM QUALITY DENTAL INSTRUMENTS

- Щипцы для ортодонтии и протезирования
- Щипці для ортодонтії та протезування
- Pinces pour l'orthodontie et la prothèse
- Alicates para ortodoncia y prótesis
- Zangen für Kieferorthopädie und Prothetik
- كمامة لتقويم الأسنان بروستييس



Max. Ø 0,7mm
Max. Ø 0,9mm

SSI-E-110
Universal Pliers
for soft and hard wire
160mm



SSI-E-111
Thick grooved plier
145mm



SSI-E-112
Bird's beak claw with cutter
130mm



SSI-E-113
Elastomeric Separator
Placing Pliers 160mm



SSI-E-114
for incisors with
convex beaks
160mm



SSI-E-115
For bicuspid
and molars
with concave beaks
160mm

Щипцы для ортодонтии и протезирования Щипці для ортодонтії та протезування
Pinces pour l'orthodontie et la prothèse Alicates para ortodoncia y prótesis
Zangen für Kieferorthopädie und Prothetik كماشة لتكوين الأسنان بروستھتیس

CUTTERS



SSI-E-116
Hard
Wire Cutter 15



SSI-E-120
Mini Pin &
Ligature Cutter



SSI-E-117
Distal End Cutter
Flush Cut



SSI-E-121
Hard Wire Cutter
Straight

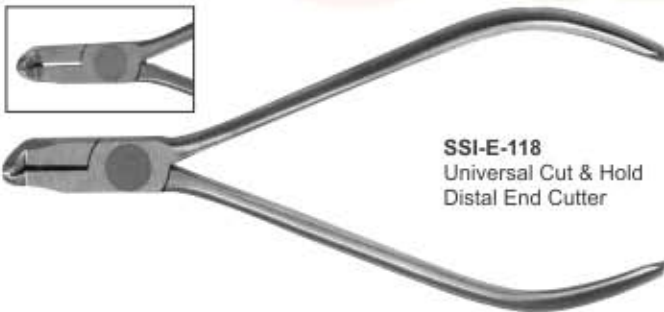

SSI-E-118
Universal Cut & Hold
Distal End Cutter

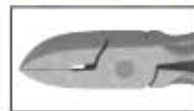

SSI-E-122
Micro-Mini Pin &
Ligature Cutter



SSI-E-119
Pin & Ligature
Cutter



SSI-E-123
Cutter

- Щипцы для ортодонтии и протезирования
- Щипці для ортодонтії та протезування
- Pinces pour l'orthodontie et la prothèse
- Alicates para ortodoncia y prótesis
- Zangen für Kieferorthopädie und Prothetik
- كمامة لتقويم الأسنان بروستيثيس

CUTTER, UTILITY PLIERS & WIRE FORMING PLIERS



SSI-E-124
Weingart Pliers



SSI-E-129
Adhesive
Removing Pliers



SSI-E-125
Slim Weingart
Pliers

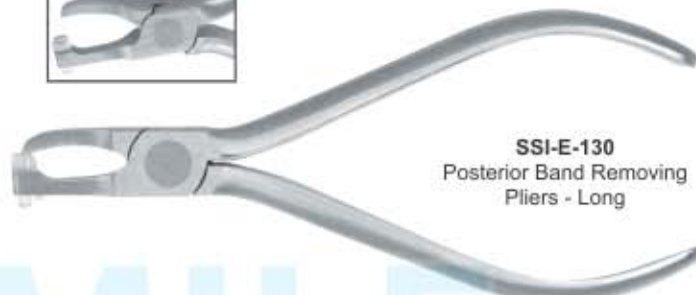

SSI-E-130
Posterior Band Removing
Pliers - Long



SSI-E-126
How Pliers
Straight



SSI-E-131
Posterior Band Removing
Pliers - Short

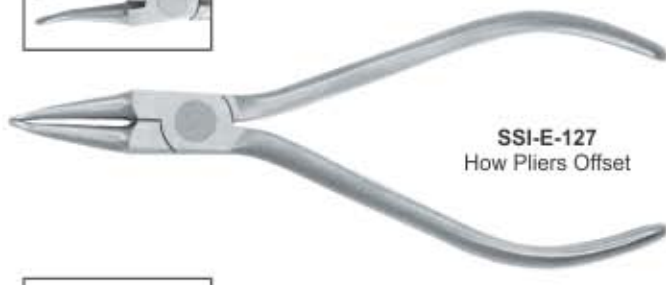

SSI-E-127
How Pliers Offset

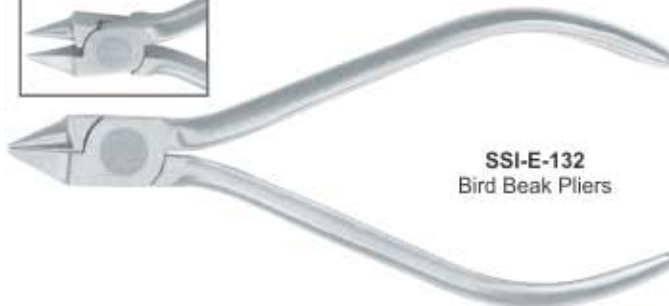

SSI-E-132
Bird Beak Pliers



SSI-E-128
Band seating Pliers



Replacement tip and
hex key included.



SSI-E-133
Omega Loop
Forming Pliers

Щипцы для ортодонтии и протезирования
Pincers pour l'orthodontie et la prothèse
Zangen für Kieferorthopädie und Prothetik

Щипці для ортодонтії та протезування
Alicates para ortodoncia y prótesis
كماشة لتكوين الأسنان بروتیثتیس



SSI-E-134
Three Jaw Pliers



SSI-E-138
Jarabak Pliers



SSI-E-135
Light Wore Bird Beak
Pliers with Groove



SSI-E-139
Hollow Chop
Contouring Pliers



SSI-E-136
Tweed loop
Forming Pliers



SSI-E-140
Lingual Arch
Forming Pliers



SSI-E-137
Arch Bending Pliers



SSI-E-141
Rectangular Arch
Bending Pliers

- | | |
|---|-------------------------------------|
| Щипцы для ортодонтии и протезирования | Щипці для ортодонті та протезування |
| Pinces pour l'orthodontie et la prothèse | Alicates para ortodoncia y prótesis |
| Zangen für Kieferorthopädie und Prothetik | كمانشة لتقويم الأسنان بروستيتيس |

For Special Packing of Orthodontic Pliers Please Ask



SSI-E-142



SSI-E-143



SSI-E-144

Щипцы для ортодонтии и протезирования Щипці для ортодонті та протезування
Pinces pour l'orthodontie et la prothèse Alicates para ortodoncia y prótesis
Zangen für Kieferorthopädie und Prothetik كماشة لتكوين الأسنان بروستيثيس

L-KEY JOINT PLIERS
T.C.



SSI-E-145
T.C Distal end cutter with safety hold, mini head, long handles.
fitted with un-breakable, corrosion resistant and durable stainless steel tips

- 0.30 mm to 0.50 mm (.012" to .020")
- Max. 0.46 mm x 0.64 mm (.018" x .025")
- ⊗ 0.38 mm to 0.53 mm (.0155" to .0215")
- ⊗ Max. 0.53 mm x 0.64 mm (.021" x .025")



SSI-E-146
T.C Flush-cut distal end cutter with safety hold fitted with un-breakable, corrosion resistant and durable stainless steel tips

- 0.30 mm to 0.50 mm (.012" to .020")
- Max. 0.46 mm x 0.64 mm (.018" to .025")



SSI-E-147
T.C Soft wire and ligature cutter, Mini fitted with un-breakable, corrosion resistant and durable stainless steel tips

- ⌋ .25 mm to .38 mm (.010" to .015")



SSI-E-148
T.C Soft wire and ligature cutter, standard fitted with un-breakable, corrosion resistant and durable stainless steel tips

- ⌋ .25 mm to .38 mm (.010" to .015")



SSI-E-149
T.C Soft wire and ligature cutter, 15° angled fitted with un-breakable, corrosion resistant and durable stainless steel tips

- ⌋ .25 mm to .38 mm (.010" to .015")



SSI-E-150
T.C Soft wire and ligature cutter, 45° angled fitted with un-breakable, corrosion resistant and durable stainless steel tips

- ⌋ .25 mm to .38 mm (.010" to .015")



SSI-E-151
T.C Hard wire cutter, straight Fitted with un-breakable, corrosion resistant and durable stainless steel tips

- 0.30 mm to 0.50 mm (.012" to .020")
- Max. 0.56 mm x 0.71 mm (.022" x .028")



SSI-E-152
T.C Hard wire cutter, 15° angled Fitted with un-breakable, corrosion resistant and durable stainless steel tips

- 0.30 mm to 0.50 mm (.012" to .020")
- Max. 0.56 mm x 0.71 mm (.022" x .028")



SSI-E-153
T.C Hard wire cutter, 15° angled Non-autoclavable

- 0.30 mm to 0.50 mm (.012" to .020")
- Max. 0.56 mm x 0.71 mm (.022" x .028")

■ Щипцы для ортодонтии и протезирования ■ Щипці для ортодонтії та протезування
■ Pincers pour l'orthodontie et la prothèse ■ Alicates para ortodoncia y prótesis
■ Zangen für Kieferorthopädie und Prothetik ■ كمانشة لتقويم الأسنان بروستھتیس

L-KEY JOINT PLIERS
T.C



SSI-E-154
T.C Band removing pliers



SSI-E-159
T.C Weingart-mini Utility Pliers

- 0.30 mm to 0.50 mm (.012" to .020")
- Max 0.56 mm x 0.71 mm (.022" x .028")



SSI-E-155
T.C Bracket removing pliers angled

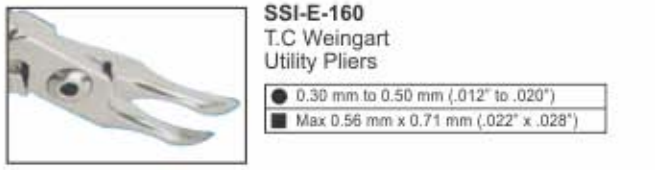

SSI-E-160
T.C Weingart Utility Pliers

- 0.30 mm to 0.50 mm (.012" to .020")
- Max 0.56 mm x 0.71 mm (.022" x .028")



SSI-E-156
T.C Bracket removing pliers straight



SSI-E-161
T.C How Straight Utility Pliers

- 0.30 mm to 0.50 mm (.012" to .020")
- Max 0.56 mm x 0.71 mm (.022" x .028")



SSI-E-157
T.C Bracket removing pliers with plastic tip

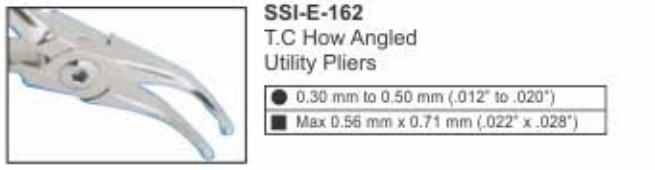

SSI-E-162
T.C How Angled Utility Pliers

- 0.30 mm to 0.50 mm (.012" to .020")
- Max 0.56 mm x 0.71 mm (.022" x .028")



SSI-E-158
T.C Adhesive removing pliers



SSI-E-163
T.C Wire bending and loop forming pliers Angled (Bird beak)

- 0.30 mm to 0.50 mm (.012" to .020")
- Max 0.56 mm x 0.71 mm (.022" x .028")

PREMIUM QUALITY DENTAL INSTRUMENTS

Щипцы для ортодонтии и протезирования
Pincettes pour l'orthodontie et la prothèse
Zangen für Kieferorthopädie und Prothetik

Щипці для ортодонції та протезування
Alicates para ortodoncia y prótesis
كمانشة لتكوين الأسنان بروستيثيس

L-KEY JOINT PLIERS
T.C.



SSI-E-164
T.C Cinch Back / tie back
Distal end bending pliers

● 0.30 mm to 0.50 mm (.012" to .020")
■ Max. 0.56 mm x 0.71 mm (.022" x .028")



SSI-E-165
T.C Detailing step pliers / Bayonet
bending pliers - 1mm

● 0.30 mm to 0.50 mm (.012" to .020")
■ Max. 0.56 mm x 0.71 mm (.022" x .028")



SSI-E-166
T.C Stop pliers V-Bebd - 1mm

● 0.30 mm to 0.50 mm (.012" to .020")
■ Max. 0.43 mm x 0.56 mm (.017" x .028")



SSI-E-167
T.C Tweed / angel
Rectangular arch forming and
torquing pliers

● 0.30 mm to 0.71 mm (.012" to .028")
■ Max. 0.56 mm x 0.71 mm (.022" x .028")



SSI-E-168
T.C Surgical ball hook crimping
pliers, straight

L-KEY JOINT PLIERS
Without T.C.



SSI-E-169
Multi-purpose pliers, bird beak,
De la rosa and cutter in one

● 0.30 mm to 0.50 mm (.012" to .020")
■ Max. 0.46 mm x 0.56 mm (.018" x .022")



SSI-E-170
Hammer head
Distal end bending pliers

● 0.30 mm to 0.50 mm (.012" to .020")
■ Max. 0.56 mm x 0.71 mm (.022" x .028")



SSI-E-171
Nance
Loop forming pliers

● 0.36 mm to 0.71 mm (.014" to .028")
■ Max. 0.56 mm x 0.71 mm (.022" x .028")



SSI-E-172
Lingual / palatal arch forming pliers

● 0.76 mm (.030") / 0.91 mm (.036")



SSI-E-173
Torquing pliers



SSI-E-174
Surgical ball hook crimping pliers,
angled

- Щипцы для ортодонтии и протезирования
- Щипці для ортодонтії та протезування
- Pinces pour l'orthodontie et la prothèse
- Alicates para ortodoncia y prótesis
- Zangen für Kieferorthopädie und Prothetik
- كمامة لتقويم الأسنان بروستيتيس

L-KEY JOINT PLIERS



SSI-E-175
Aderer Clamp three jaw wire bending plier for contouring and bending wire up to .30"/.76mm.



SSI-E-181
Falcon beak contouring plier.

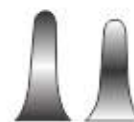

SSI-E-176
Bird beak plier for bending round, square and rectangle wire up to .30"/.76mm.

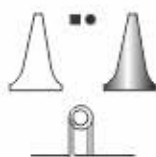

SSI-E-182
For placement and removal of arch wires, pins and other auxiliaries.



SSI-E-177
Bird beak plier for light wire bending round, square and rectangular up to .016"/0.41mm.



SSI-E-183
For placement and removal of arch wires, pins and other auxiliaries in angle design



SSI-E-178
Double Rounded jaw bending pliers, hooks and wire up to .020"/0.51mm.

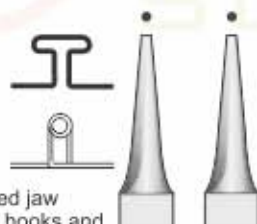

SSI-E-184
contouring Plier.



SSI-E-185
Bending plier. In order to skirt molares bands. With grooved. Recommended wire. 016", 018" and 022" 0.41mm, 0.46mm and 0.56mm



SSI-E-179
Adams pliers for hooks and bending wire up to .030"/0.76mm.



SSI-E-186
Loop forming in four length 3,4,5 & 6 mm wire capacity 0.22", 56mm.



SSI-E-180
Johnson pliers for crown band contouring



SSI-E-187
Arch bending plier design for convenient handling of square or rectangular wire, .020" / 0.51mm.



Щипцы для ортодонтии и протезирования Щипці для ортодонтії та протезування
Pinces pour l'orthodontie et la prothèse Alicates para ortodoncia y prótesis
Zangen für Kieferorthopädie und Prothetik كمانشة لتكوين الأسنان بروستيثيس



SSI-E-188
Thermo Forming Pliers



SSI-E-189
Thermo Forming Pliers



SSI-E-190
Thermo Forming Pliers



SSI-E-190A
Ortho Pliers



SSI-E-190B
Ortho Pliers



SSI-E-190C
Ortho Pliers



SSI-E-190D
Ortho Pliers



SSI-E-190E
Ortho Pliers

- | | |
|---|--------------------------------------|
| Щипцы для ортодонтии и протезирования | Щипці для ортодонтії та протезування |
| Pinces pour l'orthodontie et la prothèse | Alicates para ortodoncia y prótesis |
| Zangen für Kieferorthopädie und Prothetik | كمامة لتقويم الأسنان بروستييس |

LAP & L-KEY JOINT PLIERS



SSI-E-191
Pin & Ligature Cutters
TC. Gold.



SSI-E-192
Mini Pin & Ligature
Cutter TC. Gold.



SSI-E-193
Standard Ligature
Cutter TC. Gold.



SSI-E-194
Distal end Cutter
TC. Gold.



SSI-E-195
Distal end Cutter
Long Handle
TC. Gold.



SSI-E-196
Hook Crimping Plier Angled
TC. Gold.



SSI-E-197
Distal end Cutter, Safety Hold Plier
(Ideal for Cutting Wire) TC. Gold.

Щипцы для ортодонтии и протезирования Щипці для ортодонтії та протезування
Pinces pour l'orthodontie et la prothèse Alicates para ortodoncia y prótesis
Zangen für Kieferorthopädie und Prothetik كماشة لتكوين الأسنان بروستھتیس

L-KEY JOINT PLIERS



SSI-E-198
Direct Bracket Remover
TC. Gold.



SSI-E-199
Straight Direct Bond Bracket
Remover T.C



SSI-E-200
Pin Holding Plier



SSI-E-201
3 Prong Clasp Adjustable
Plier TC. Gold.



SSI-E-202
Utility Plier Weingart TC. Gold.



SSI-E-203
Nance Plier TC. Gold.

- | | |
|---|--------------------------------------|
| Щипцы для ортодонтии и протезирования | Щипці для ортодонтії та протезування |
| Pinces pour l'orthodontie et la prothèse | Alicates para ortodoncia y prótesis |
| Zangen für Kieferorthopädie und Prothetik | كمامة لتقويم الأسنان بروستييس |



SSI-E-204
Separating Pliers For Separators
155mm



SSI-E-205
Elastic
Separating Plier



SSI-E-206 Straight
SSI-E-207 Curved
Smaha Elastomeric ligature
placing forceps
140 mm



SSI-E-208
Elastomeric ligature placing
forceps with groove
140 mm



SSI-E-209
Elastomeric ligature placing
forceps with groove
140 mm

Щипцы для ортодонтии и протезирования Щипці для ортодонтії та протезування
Pinces pour l'orthodontie et la prothèse Alicates para ortodoncia y prótesis
Zangen für Kieferorthopädie und Prothetik کمانچه لتقویم الأسنان بروتیستیس



SSI-E-210
Methieu Plier
With Ring



SSI-E-211
Pliers to Place Modules
140mm

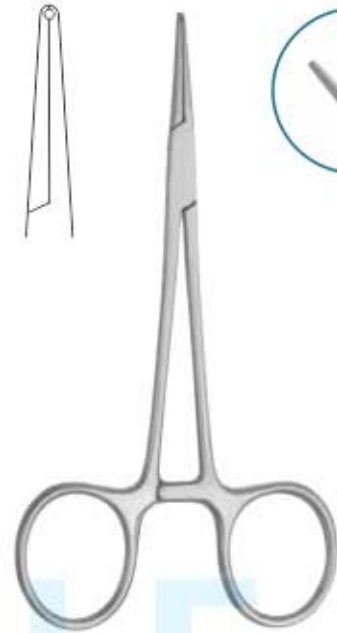

SSI-E-212
Forceps For Placing Dentalastics
120mm



SSI-E-213
Mathieu
140mm



SSI-E-214
Mathieu Ligature Pliers
140mm



SSI-E-215
Ligature Pliers T.C Gold
With Tungsten Carbide Inserts
140mm



Ligature Pliers
140mm



SSI-E-216 SSI-E-217 SSI-E-218

■ Ортодонтия Шипцы Подставки
■ Supports de pinces d'orthodontie
■ Kieferorthopädie Zangenständer

■ Ортодонтия Шипці Підставки
■ KFO Zangen Ständer
■ تقويم الأسنان كمشاة تقف



SSI-E-219
Plier Stand
Stainless Steel.



SSI-E-220
Plier Stand
Stainless Steel.



SSI-E-221
Pliers Stand
Stainless Rod
(Aluminum Anodized)
Stainless Steel



SSI-E-222
Plier Stand
Stainless Steel.



SSI-E-223
Plier Stand
Stainless Steel.



SSI-E-224
Plier Stand
Plastic



Maxillary sinus

Impacted wisdom teeth

Maxilla (upper jaw)

Mandible (lower jaw)

Nerve (controls feeling in the chin, gum, teeth, and lip)

	1 Silver	2 Yellow	3 Red	4 Blue	5 Green
Apical	1.8	1.9	2.1	2.8	2.8
Shank					
Width	2.8	3.0	3.4	3.8	4.3
Length	15	15	15	15	15

Wrench 4.0mm

- 2.6mm
- 3.0mm
- 3.4mm
- 3.8mm
- 4.3mm
- Pilot
- Extender
- Manual knob
- Leach adaptor
- Pin
- Pin
- Extra

Instruments for dental implants are made of high quality stainless steel.

Our line of instruments include, but is not limited to, the following products:

Bone Grafting Instruments

- Bone Curettes (SPRATT) – designed for harvesting bone
- Bone Grinder – used in conjunction with a mallet to grind bone into appropriate particle sizes
- Bone Basin – weighted bottom design prevents tipping or spilling while mixing bone or other bone grafting materials

Bone Compactors – feature serrated tips for compacting bone

Scalpels & Biopsy Punches

- Scalpels – offers convenience of a disposable with razor sharp cutting edge for superior cutting
- Biopsy Punches – designed at a steeper angle to ensure a finely honed, sharper edge
- Bone Spreading Chisels
- Freer Chisels – double or single cut tips used for widening ridges during implant preparations

- Graduated Chisels – feature reference markings for measurement during a bone ridge augmentation and are available in straight and curved patterns

Osteotomes

- Concave Osteotomes – break the floor of the maxillary sinus through the implant cavity and are available in curved (off set) and straight (with or without stops)
- Convex Osteotomes – raise the floor of the maxillary sinus and are available in curved (off set) and straight patterns (with or without stops)
- Progressive Osteotomes – designed to prepare the implant site in the maxillary area where bone density is 3 or 4
- Bone Spreading Osteotomes – sharp or blunt configurations for progressive circumferential expansion of the implant site

Sinus Lift Instruments

- Sinus Lift Curettes and Elevators – lightweight, wide diameter stainless steel hand instruments lift the sinus membrane for bone augmentation procedures

Gauges & Calipers

- Gauges & Calipers – various measuring devices available to determine appropriate length, width, and distance for implant procedures

Collagen Products

- Collagen wound dressing product offering includes products.

Sterilization Trays

- Sterilization Trays – designed to protect and store instruments during sterilization, transportation and storage



Инструменты для имплантологии
Implantologie
Implantologie

Инструменти для имплантології
Implantologia
زراعة الأسنان

IMPLANT GAGES



SSI-F-001
Multifunctional Meter
Length 90 mm,
different sizes,
8-10-11mm,
corrosion-resistant

SSI-F-002
Multifunctional Meter
Length 90 mm,
different sizes,
5-13-15-17 mm,
corrosion-resistant

SSI-F-003
Measuring Probe
Length 170 mm,
(6-8-10-14-16 mm),
corrosion-resistant

SSI-F-004
Implant
Depth Gauge

SSI-F-005
Implant
Depth Gauge
& Key

SSI-F-006
Implant
Depth Gauge

SSI-F-007
Implant
Depth Gauge

IMPLANT GAGES



SSI-F-008
Double Ended Osteotomy Depth Gauge

SSI-F-009
Double Ended Osteotomy Depth Gauge

SSI-F-010
Double Ended Osteotomy Depth Gauge

SSI-F-011
Depth & Gingival Gauges

Инструменты для имплантологии
 Implantologie
 Implantologie

Инструменти для имплантології
 Implantoloia
 زراعة الأسنان

Caliper / Calipers Rule



SSI-F-012
 Castroviejo Calipers
 20mm, 45°
 90mm



SSI-F-013
 Castroviejo Calipers
 20mm
 90mm



SSI-F-014
 Castroviejo Calipers
 20mm
 90mm



SSI-F-015
 Ridge Mapping
 Double Caliper



SSI-F-016
 Fig. 5
 Castroviejo
 18cm



SSI-F-017
 Fig. 4
 Castroviejo
 18cm



SSI-F-018
 Fig. 3
 Castroviejo
 18cm



SSI-F-019
Clamp, Osteometer
Length about 155 mm,
ridge width measurement,
two-sided scale,
measuring
range 0 - 25 mm



SSI-F-020
Measuring Loop
straight length 90 mm,
measuring range
0 - 40 mm,



SSI-F-021
Measuring Loop
angled, length 90 mm,
measuring range
0 - 40 mm,



SSI-F-022
Measuring loop, Castroviejo
angled, length 175 mm,
measuring range 0 - 40 mm,
with window



SSI-F-023
Measuring Loop
angled, length
175 mm,
measuring range
0 - 40 mm,



SSI-F-024
Measuring Loop
straight length
175 mm,
measuring range
0 - 40 mm,



SSI-F-025
Fig. 1
Iwanson
spring caliper
For metal and
porcelain.



SSI-F-026
Fig. 2
Iwanson
spring caliper
For wax.



SSI-F-027
Bone Thickness Gauge
40mm, 180mm

Инструменты для имплантологии
 Implantologie
 Implantologie

Инструменти для имплантології
 Implantoloia
 زراعة الأسنان



SSI-F-028
Boley Gauge



SSI-F-029
Vernier Gauge



SSI-F-030
Aluminium Caliper
up to 200mm



SSI-F-031
Boley Gauge



SSI-F-032
Delux Boley
Gauge



SSI-F-033
Beerendonk
130mm
Mini Gauge

Инструменты для имплантологии
 Implantologie
 Implantologie

Инструменти для имплантології
 Implantologia
 زراعة الأسنان



SSI-F-034
Micro Boley
Gauge Twisted



SSI-F-035
Micro Boley
Gauge Straight



SSI-F-036
Dentaurum Ruler



SSI-F-037
Ruler Wedge



SSI-F-038
Ruler



SSI-F-039
Ortho Ruler / Cone Socket

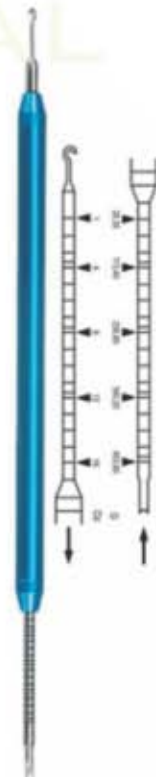

SSI-F-040
Dynamometer

Инструменты для имплантологии
Implantologie
Implantologie

Инструменти для имплантології
Implantoloia
زراعة الأسنان

BLACK TITANIUM COLOUR COATED INSTRUMENTS
Available in Hollow Handle Ø 8 mm, Ø 10 mm Solid Handle Ø 6 mm



SSI-F-041
Fig. 1

SSI-F-042
Fig. 2

SSI-F-043
Fig. 3
Extra-Flex

SSI-F-044
Micro-Mini

SSI-F-045
Mini 1

SSI-F-046
Mini 4
Extra-Flex

SSI-F-047
Fig. 4
Extra-Flex

SSI-F-048
Fig. 5
Flexi-Thin

SSI-F-049
Fig. 6
Flexi-Thin

SSI-F-050
Mini 3
Extra-Flex

Инструменты для имплантологии
Implantologie
Implantologie

Инструменти для имплантології
Implantologia
زراعة الأسنان

BLACK TITANIUM COLOUR COATED INSTRUMENTS
Available in Hollow Handle Ø 8 mm, Ø 10 mm Solid Handle Ø 6 mm

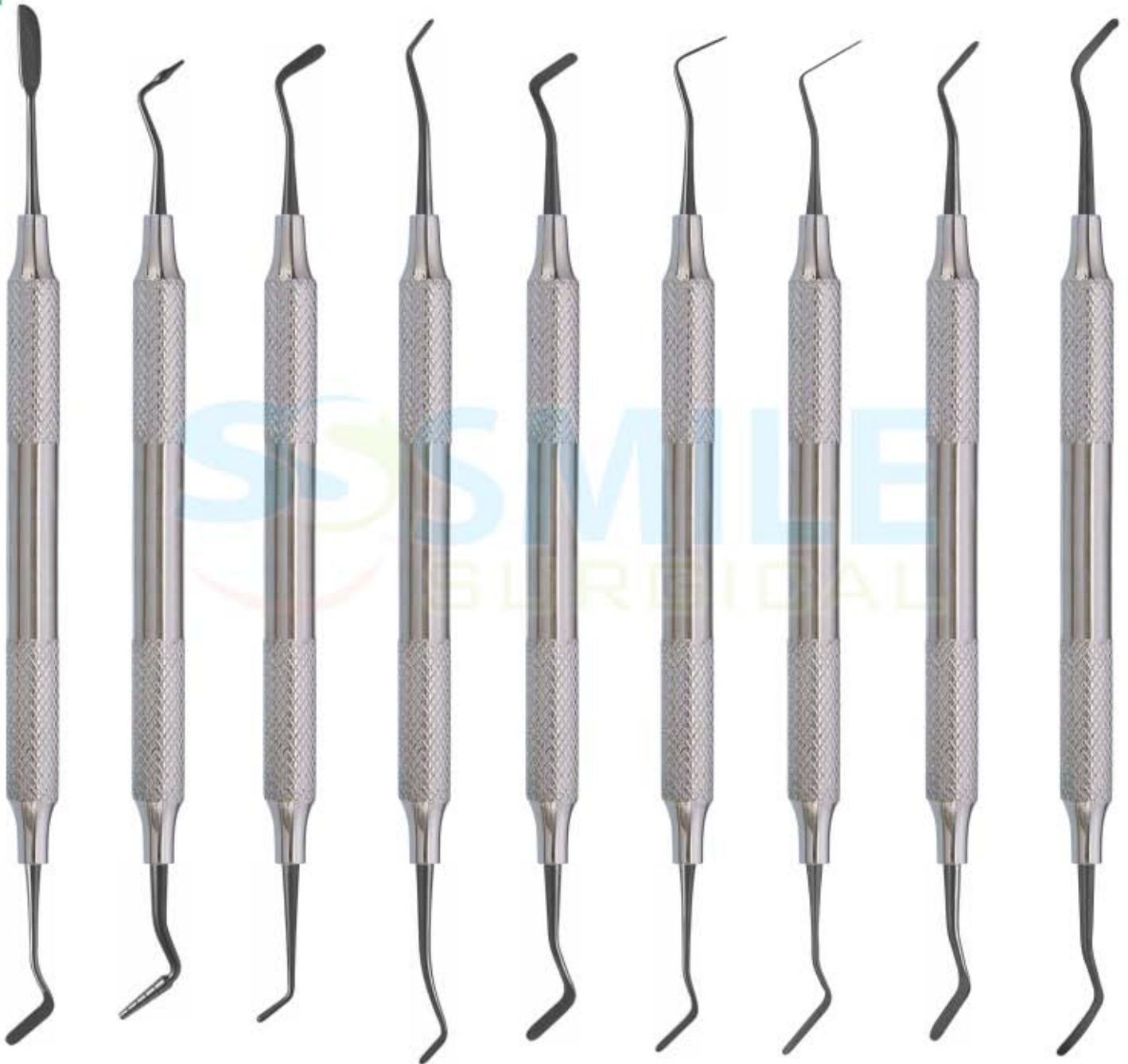

SSI-F-051
AB1
Boghosian

SSI-F-052
AB2
Boghosian

SSI-F-053
W3

SSI-F-054
8A

SSI-F-055
4/5
Gregg

SSI-F-056
Interproximal
Carver

SSI-F-057
Interproximal
Carver, Long

SSI-F-058
A6

SSI-F-059
Contouring
instrument

Инструменты для имплантологии
 Implantologie
 Implantologie

Инструменти для имплантології
 Implantoloia
 زراعة الأسنان

BLACK TITANIUM COLOUR COATED INSTRUMENTS
 Available in Hollow Handle Ø 8 mm, Ø 10 mm Solid Handle Ø 6 mm

BURNISHERS

FREEDMAN BURNISHERS



SSI-F-060
21B

SSI-F-061
27/29

SSI-F-062
2
Ladmore

SSI-F-063
3
Ladmore

SSI-F-064
Freedman
"Duckhead"

SSI-F-065
Freedman
Small Contact
Forming

SSI-F-066
Freedman
Large Contact
Forming

SSI-F-067
Small/
Medium Ball
Burnisher

Инструменты для имплантологии
Implantologie
Implantologie

Инструменти для имплантології
Implantologia
زراعة الأسنان

BLACK TITANIUM COLOUR COATED INSTRUMENTS
Available in Hollow Handle Ø 8 mm, Ø 10 mm Solid Handle Ø 6 mm



SSI-F-068
A
Cosmetic
Contouring

SSI-F-069
B
Cosmetic
Contouring

SSI-F-070
C
Cosmetic
Contouring

SSI-F-071
D
Cosmetic
Contouring

SSI-F-072
E
Cosmetic
Contouring

SSI-F-073
F
Cosmetic
Contouring

SSI-F-074
Marginal Ridge
& Embrasure
Shaping Instrument

SSI-F-075
Occlusal
Anatomy
Instrument

SSI-F-076
Composite
Packing
Instrument

Инструменты для имплантологии
 Implantologie
 Implantologie

Инструменти для імплантології
 Implantoloia
 زراعة الأسنان

BLACK TITANIUM COLOUR COATED INSTRUMENTS
 Available in Hollow Handle Ø 8 mm, Ø 10 mm Solid Handle Ø 6 mm



SSI-F-077
Fig. 3
Extra-Flex

SSI-F-078
Mini 1

SSI-F-079
Micro-Mini

SSI-F-080
Medium
Placing/
Condensing

SSI-F-081
Large
Placing/
Condensing

SSI-F-082
OT
Tanner

SSI-F-083
3
Hollenback

SSI-F-084
5A

SSI-F-085
Small/Medium
Contact
Forming

SSI-F-086
Medium/Large
Contact
Forming

Инструменты для имплантологии
Implantologie
Implantologie

Инструменти для имплантології
Implantologia
زراعة الأسنان

TITANIUM PLASMA COLOUR COATED SINUS LIFT INSTRUMENTS
Available in Hollow Handle Ø 8 mm, Ø 10 mm Solid Handle Ø 6 mm



SSI-F-087
Sinus Lift Elevator

SSI-F-088
Sinus Lift Elevator

SSI-F-089
Sinus Lift Elevator

SSI-F-090
Sinus Lift Elevator

SSI-F-091
Sinus Lift Elevator

Инструменты для имплантологии
Implantologie
Implantologie

Инструменти для имплантології
Implantoloia
زراعة الأسنان

TITANIUM PLASMA COLOUR COATED SINUS LIFT INSTRUMENTS
Available in Hollow Handle Ø 8 mm, Ø 10 mm Solid Handle Ø 6 mm



SSI-F-092
Sinus Lift Elevator

SSI-F-093
Sinus Lift Elevator

SSI-F-094
Sinus Lift Elevator

SSI-F-095
Sinus Lift Elevator

Инструменты для имплантологии
Implantologie
Implantologie

Инструменти для имплантології
Implantologia
زراعة الأسنان

TITANIUM PLASMA COLOUR COATED IMPLANT SINUS LIFT INSTRUMENTS
Available in Hollow Handle Ø 8 mm, Ø 10 mm Solid Handle Ø 6 mm

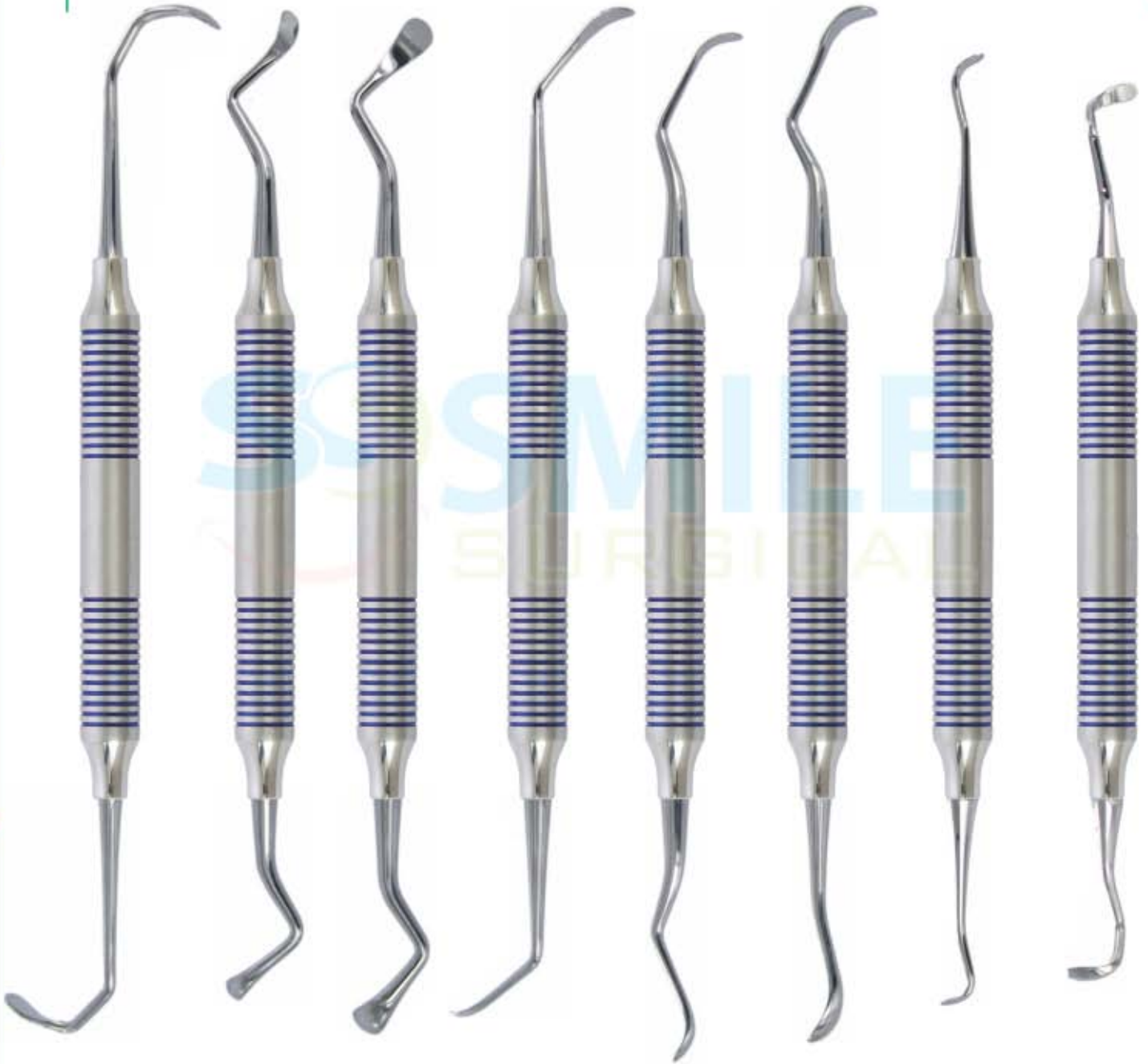

SSI-F-096
Acute 6577

SSI-F-097
Sinus1

SSI-F-098
Sinus2

SSI-F-099
Sinus3

SSI-F-100
Sinus4

SSI-F-101
Sinus5

SSI-F-102
Sinus6

SSI-F-103
Sinus7

Инструменты для имплантологии
Implantologie
Implantologie

Инструменти для имплантології
Implantoloia
زراعة الأسنان

TITANIUM PLASMA COLOUR COATED SINUS LIFT INSTRUMENTS
Available in Hollow Handle Ø 8 mm, Ø 10 mm Solid Handle Ø 6 mm



SSI-F-104
Sinuslift 1

SSI-F-105
Sinuslift 2

SSI-F-106
Sinuslift 3

SSI-F-107
Sinuslift 4

SSI-F-108
Sinuslift 5

SSI-F-109
Sinuslift 6

SSI-F-110
Membrane
3Positioning 1

SSI-F-111
Condenser 1

Инструменты для имплантологии
Implantologie
Implantologie

Инструменти для имплантології
Implantologia
زراعة الأسنان

TITANIUM PLASMA COLOUR COATED INSTRUMENTS
Available in Hollow Handle Ø 8 mm, Ø 10 mm Solid Handle Ø 6 mm

Sinus Lift Instrument,
Flexible Sinus Lift instruments
reduce the risk of perforation of the
"Schneider's membrane"

Sinus Lift Elevator,
9.5mm Straight grip
Length 175 mm, Sinus lift elevators, dull,
for gentle peeling and lifting the
Schneider membrane

Sinus lift instrument
9.5mm Straight grip Length 180 mm,
Buser (B1, B2, B3) raspatories,
quality medical stainless steel,
corrosion-resistant

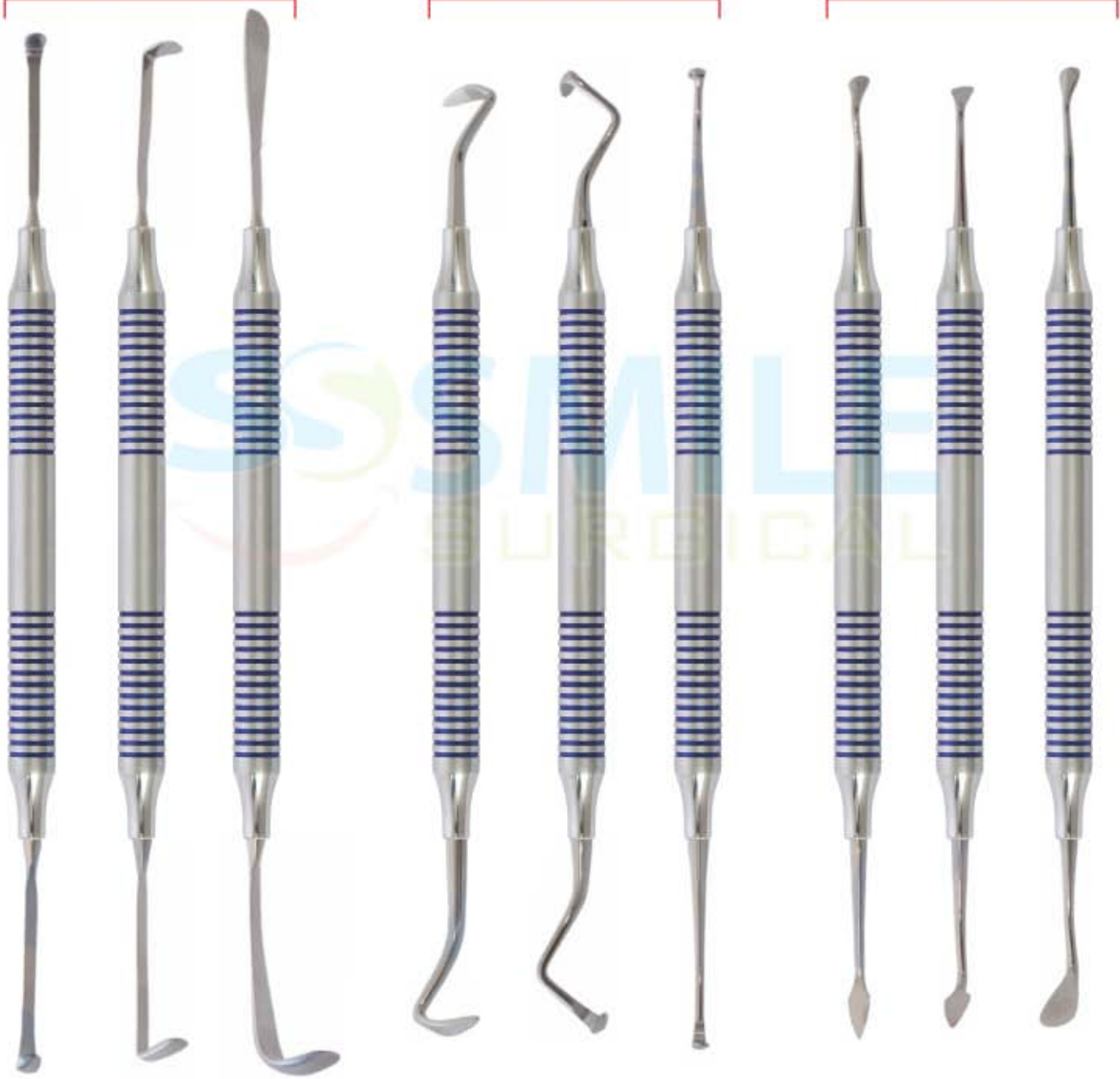

SSI-F-112
Fig. 1

SSI-F-113
Fig. 2

SSI-F-114
Fig. 3

SSI-F-115
Fig. 1

SSI-F-116
Fig. 2

SSI-F-117
Fig. 3

SSI-F-118
B01

SSI-F-119
B02

SSI-F-120
B03

Инструменты для имплантологии
 Implantologie
 Implantologie

Инструменти для имплантології
 Implantoloia
 زراعة الأسنان

TITANIUM PLASMA COLOUR COATED INSTRUMENTS
 Available in Hollow Handle Ø 8 mm, Ø 10 mm Solid Handle Ø 6 mm
 Sinus lift instrument 9.5mm Straight grip Sinus lift elevators, blunt or sharply curved
 (H01, H02, K03, K04, K78, K77)



SSI-F-121
Sinus lift instrument
H01

SSI-F-122
Sinus lift instrument
H02

SSI-F-123
Sinus lift instrument
K03

SSI-F-124
Sinus lift instrument
K04

SSI-F-125
Sinus lift instrument
K78

SSI-F-126
Sinus lift instrument
K77

Инструменты для имплантологии
 Implantologie
 Implantologie

Инструменти для имплантології
 Implantologia
 زراعة الأسنان

TITANIUM PLASMA COLOUR COATED INSTRUMENTS
 Available in Hollow Handle Ø 8 mm, Ø 10 mm Solid Handle Ø 6 mm

SINUS LIFT INSTRUMENT
 Sinus Lift Elevators, 9.5mm Hollow Handle length 170mm Blunt Curved Set of 6 Pcs

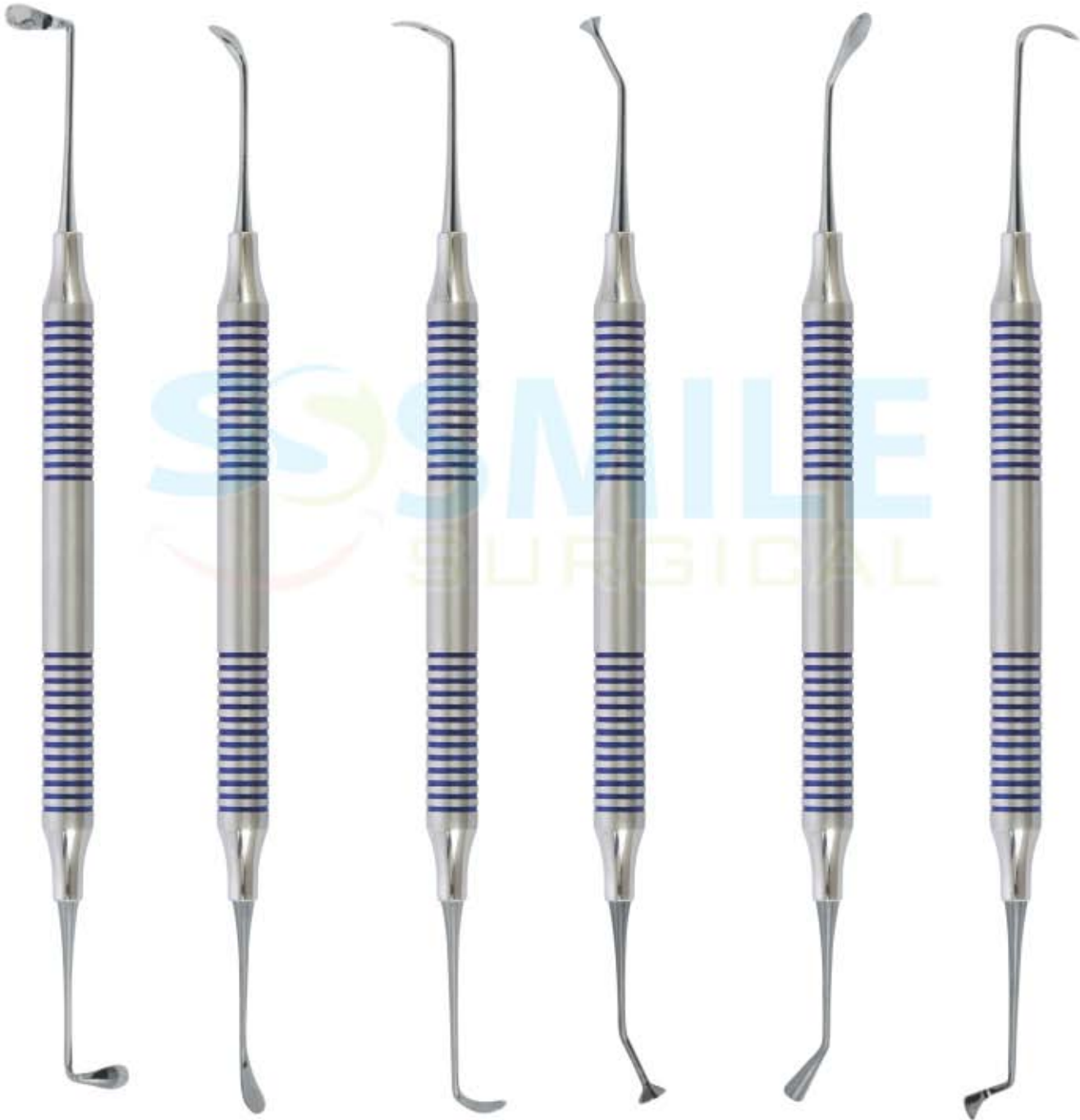

SSI-F-127

SSI-F-128

SSI-F-129

SSI-F-130

SSI-F-131

SSI-F-132

Инструменты для имплантологии
Implantologie
Implantologie

Инструменти для имплантології
Implantologia
زراعة الأسنان

Available in Hollow Handle Ø 8 mm, Ø 10 mm Solid Handle Ø 6 mm
PERIODONTAL SURGERY SURGICAL CHISELS
KRAMER NEVINS SINUS LIFT

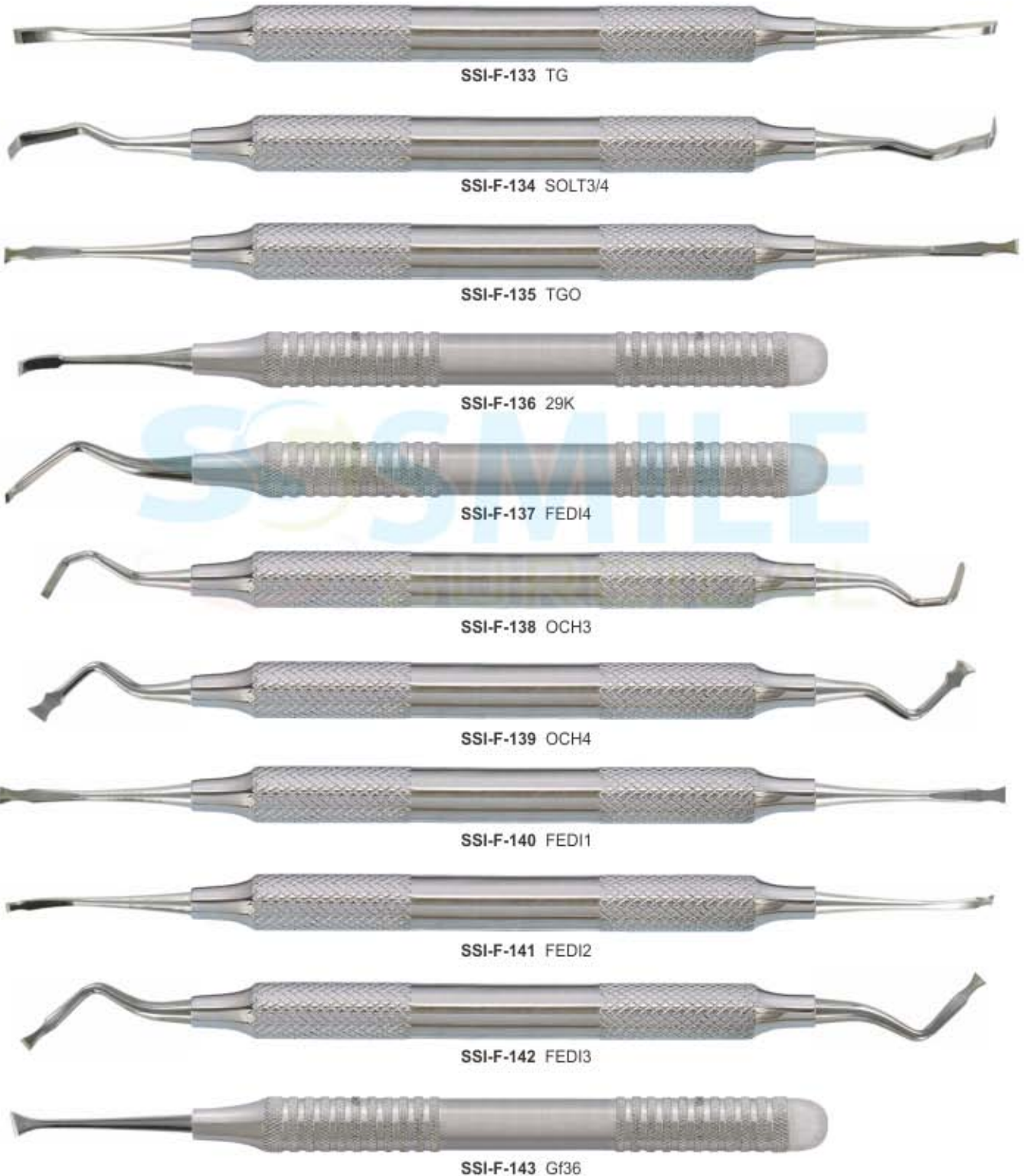

Инструменты для имплантологии
Implantologie
Implantologie

Инструменти для имплантології
Implantologia
زراعة الأسنان

Available in Hollow Handle Ø 8 mm, Ø 10 mm Solid Handle Ø 6 mm
IMPLANT SURGICAL CHISELS



SSI-F-144 13K/TG



SSI-F-145 13K/TG Titanium Plasma Coated Point



SSI-F-146 13K/TG



SSI-F-147 13KL/R Titanium Plasma Coated Point



SSI-F-148 13KL 4/6mm



SSI-F-149 Pt2 Titanium Plasma Coated Point
A/V Regular



SSI-F-150 Pt1 Titanium Plasma Coated Point
A/V Regular



SSI-F-151 Pt3 Titanium Plasma Coated Point Angel S/E



SSI-F-152 Pt4 Titanium Plasma Coated Point STR S/E



SSI-F-153 Pt5 Titanium Plasma Coated Point TG CVD S/E

Инструменты для имплантологии
Implantologie
Implantologie

Инструменти для имплантології
Implantoloia
زراعة الأسنان

TITANIUM PLASMA COLOUR COATED INSTRUMENTS
Hollow Handle 10mm
MIXING SPATULA WITH SHOVEL



SSI-F-154
Bone Carrier
Titanium
185mm



SSI-F-155
Raspator, Prichard
Length 180 mm,
10 mm hollow handle,
double-ended
10.5 mm | 4.5 mm



SSI-F-156
Raspator, Prichard
Length 180 mm,
10 mm hollow handle,
double ended



SSI-F-157
Raspator, Prichard
Length 180 mm,
10 mm hollow handle,
double-ended
10.5 mm | 4.5 mm



SSI-F-158
Mixing Spatula
with shovel
170mm



SSI-F-159
Mixing Spatula
with shovel
185mm

BONE GRAFTING INSTRUMENTS COMPACTOR /TAMPERS

Product offering includes instruments for harvesting, mixing and compacting bone Provides clinicians with the proper instrumentation for bone grafting procedures Weighted bone basin Prevents tipping and spilling of bone and other materials during mixing

Hollow Handle 9.5mm Length 170mm



SSI-F-160
Graft Packer,
Concave Tips
DE 4/6mm

SSI-F-161
Bone Spoon/
Packer DE 3mm

SSI-F-162
Graft Packer,
Serrated Tips
DE 6/8mm

SSI-F-163
Graft Packer,
Serrated Tips
DE 3/4mm

SSI-F-164
Graft Packer,
Smooth Tips
DE 5/8mm

SSI-F-165
Titanium graft packer/
placement site depth
gauge 3.3mm & 4.0mm
Diameter tips Marked
at 8, 11, 13, 15 & 18mm

SSI-F-166
Graft Material Spoon
Concave Tip For
Larger Grafts

Инструменты для имплантологии
Implantologie
Implantologie

Инструменти для имплантології
Implantoloia
زراعة الأسنان

BONE GRAFTING INSTRUMENTS
TITANIUM PLASMA COLOUR COATED
Hollow Handle Ø 10 mm



SSI-F-167
Blade and pusher
Length 180 mm,
for straight or angled,
blade: 15 x 5 mm,
pusher: 4 mm diameter
Straight



SSI-F-168
Blade and pusher
Length 180 mm,
for straight or angled,
blade: 15 x 5 mm,
pusher: 4 mm diameter
angular



SSI-F-169
Spoon and pusher
Length 180 mm,
for angled spoon:
10 x 5 mm, pusher:
diameter 3 mm



SSI-F-170
Tunnelierungs
Instrument
length 175 mm,



SSI-F-171
Tunnelierungs
Instrument
length 175 mm,
different designs



SSI-F-172
Tampers
Length 170 mm,
for bone material,
double-ended,
diameter 3.2 mm
(2-4-6-8-10) and diameter
2.5mm (2-4-6-8-10)

Инструменты для имплантологии
 Implantologie
 Implantologie

Инструменти для имплантології
 Implantologia
 زراعة الأسنان

Pluggers

Hollow Handle 9.5mm Length 160 mm, with titanium tips for mixing and pouring of autologous, heterologous bone substitute material, diameter (3/4 or 6/8 mm)

BONE GRAFTING INSTRUMENTS



SSI-F-173 Ø 4mm
 SSI-F-174 Ø 5mm
 Compactor
 150mm



SSI-F-175
 Sinus Window
 Bone Tamper
 4 mm



SSI-F-176
 Sinus Window
 Bone Tamper
 7 mm



SSI-F-177
 6/8mm



SSI-F-178
 3/4mm

Инструменты для имплантологии
Implantologie
Implantologie

Инструменти для имплантології
Implantologia
زراعة الأسنان

SPOON AND PUSHER (TRINOVO)

Hollow Handle Ø 10 mm Length 180mm



SSI-F-179
10x5mm
Spoon and
Pusher
with safety
stop

SSI-F-180
10x5mm
Spoon and
Pusher
with safety
stop

SSI-F-181
10x5mm
Spoon and
Pusher
with safety
stop

SSI-F-182
Bone Graft/Carrier
Titanium
2-4-6-8-10mm

SSI-F-183
15x10mm
Spoon and
Pusher
with safety
stop

SSI-F-184
10x5mm
Spoon and
Pusher
with safety
stop

SSI-F-185
10x5mm
Spoon and
Pusher
with safety
stop

PERIOSTEALS ELEVATOR 10mm Hollow Handle



SSI-F-186
Raspator,
Bone Scraper
Length 165 mm,
10 mm hollow
handle,
double-ended 6
mm / 4 mm,

SSI-F-187
Raspator,
Raspatory
Length 180 mm,
10 mm hollow
handle,
double-ended
3 mm | 3 mm,

SSI-F-188
Raspator,
Raspatory
Length 180 mm,
10 mm hollow
handle,
double-ended
3 mm | 3 mm,

SSI-F-189
Raspator,
Papilla
Length 185 mm,
10 mm hollow
handle,
double-ended
3 mm | 2 mm,

SSI-F-190
Raspator,
Bone Scraper
Length 175 mm,
10 mm hollow
handle,
double-ended,

SSI-F-191
Raspator,
Micro-Freer
Length 180 mm,
10 mm hollow
double-ended
3 mm | 4 mm

SSI-F-192
Raspator,
Freer
Length 180 mm,
10 mm hollow
handle,
double-ended
5 mm | 5 mm,

Инструменты для имплантологии
 Implantologie
 Implantologie

Инструменти для имплантології
 Implantoloia
 زراعة الأسنان

PERIOSTEALS ELEVATOR 10mm Hollow Handle



SSI-F-193
 Raspator,
 Freer
 10 mm hollow
 handle,
 high-quality
 medical
 double ended

SSI-F-194
 Raspator,
 Molt
 Length 180 mm,
 10 mm Hollow
 grip,
 double-ended
 6 mm

SSI-F-195
 Raspator,
 Micro Freer
 Length 185 mm,
 10 mm hollow
 handle,
 double-ended

SSI-F-196
 Raspator,
 Micro Freer
 Length 185 mm,
 10 mm hollow
 handle,
 double-ended

SSI-F-197
 Raspator, Micro
 Raspator /
 Chisel
 Length 170 mm,
 10 mm hollow
 handle,
 double-ended

SSI-F-198
 Raspator, Micro
 Raspator /
 Chisel
 Length 175 mm,
 10 mm hollow
 handle,
 double-ended

SSI-F-199
 Raspator,
 Micro Raspator /
 Chisel
 Length 175 mm,
 10 mm hollow handle,
 double-ended
 3.5mm | 3.5 mm

PERIOSTEALS ELEVATOR 10mm Hollow Handle



SSI-F-200
Raspatory Micro Molt
Length 175 mm,
corrosion-resistant

SSI-F-201
Raspatory Chipping
Workers:
Chisel 24G and 7.5 mm,
length about 175 mm,
corrosion-resistant

SSI-F-202
Raspatory Molt
Work ends:
5.0 mm and 4.0 mm,
length about 175 mm,
corrosion-resistant

SSI-F-203
Rasp, Molt M9
Length 175 mm,
corrosion-resistant

SSI-F-204
Raspator, Wautier
Length 175 mm,
corrosion-resistant

SSI-F-205
Raspator, Benque
Length 170 mm,
workers
5 mm | 7 mm,
corrosion-resistant

SSI-F-206
Raspator, Nordberg
Length 180 mm,
10 mm hollow handle,
double-ended
6 mm | 4 mm

Инструменты для имплантологии
Implantologie
Implantologie

Инструменти для имплантології
Implantologia
زراعة الأسنان

Curettes
Hollow Handle 10mm Length 170mm

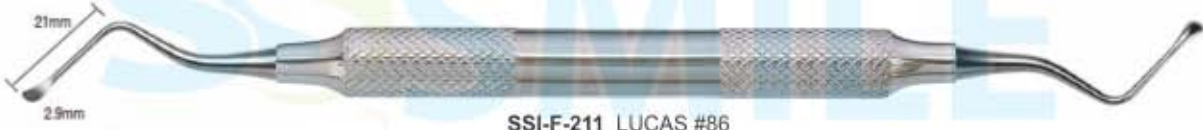

TISSUE MEMBRANE FORCEPS



SSI-F-216
Tissue Graft Forcep
Serrated Teeth
150mm



SSI-F-217
Self Locking
Grooved
150mm



SSI-F-218
Tissue Graft Forcep
Serrated Teeth
150mm



SSI-F-219
Titanium Metal
Locking Plier



SSI-F-220
TC Gripper Carbide
Tipped Tissue Forceps
Serrated Carbide Tips
145mm



SSI-F-221
Adson Carbide
Tipped Tissue Forceps
Serrated Carbide Tips
120mm



SSI-F-222
Chalazion Mucocele
Forceps
90mm Length
12mm x 23mm
Inside Ring



SSI-F-223
Micor Adson
Tissue Forcep 120mm
1x2 Teeth -
0.5mm Tips



SSI-F-224
Adson 7x7
Tissue Forceps
7x7 Teeth
120mm



SSI-F-225
Adson 7x7 Curved
Tissue Forceps
7x7 Teeth 120mm



SSI-F-226
Suture Pliers
Suture Forceps
with
1.6mm Ring Tip
160mm



SSI-F-227
Membrane Forcep
With Delicate
Ring Tip
10 cm



SSI-F-228
Debakey Atraumatic
Tissue Forceps
Straight
Serrated Teeth
160mm



SSI-F-229
Debakey Atraumatic
Tissue Forceps Curved
Serrated Teeth
160mm

Инструменты для имплантологии
Implantologie
Implantologie

Инструменти для имплантології
Implantologia
زراعة الأسنان

TISSUE MEMBRANE FORCEPS



SSI-F-230
Russian Long
Tissue Forceps
Serrated Tip
200mm



SSI-F-231
Russian
Tissue Forceps
Serrated Tip
150mm



SSI-F-232
Tissue Punch Forceps
To Remove Tissue
After Using Punch
150mm



SSI-F-233
Narrow
135mm



SSI-F-234
105mm
Membrane Tweezers Kuehne



SSI-F-235
wide
135mm



SSI-F-236
Bishop Harman
Micro Tissue Forcep
8.6cm 1x2 Teeth
- 0.3mm Tips



SSI-F-237
Pin-Tweezers
length 150mm
with lock



SSI-F-238
without lock
150mm



SSI-F-239
Haltepinzette with lock
155mm, for pins, towards
the tips, etc



SSI-F-240
Carry Forceps
150mm



SSI-F-241
Carry Forceps
150mm



SSI-F-242
Carry Forceps
150mm

Инструменты для имплантологии
Implantologie
Implantologie

Инструменти для имплантології
Implantologia
زراعة الأسنان

OSTEOTOME CONVEXES / CONCAVE / CONIQUES

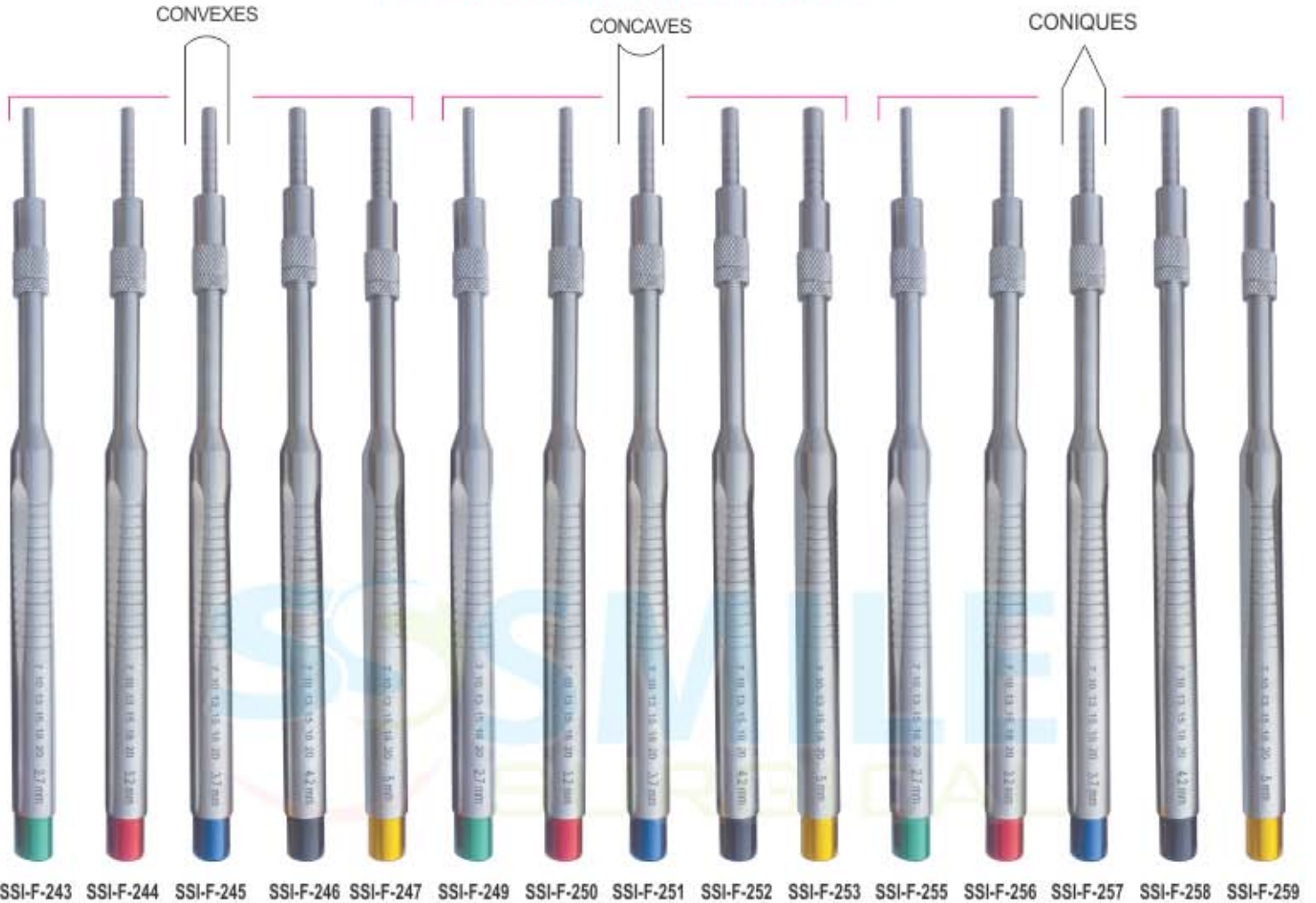



SSI-F-243 SSI-F-244 SSI-F-245 SSI-F-246 SSI-F-247 SSI-F-249 SSI-F-250 SSI-F-251 SSI-F-252 SSI-F-253 SSI-F-255 SSI-F-256 SSI-F-257 SSI-F-258 SSI-F-259

SSI-F-248 SET OF 5 PIECES Convexes

SSI-F-254 SET OF 5 PIECES Concaves

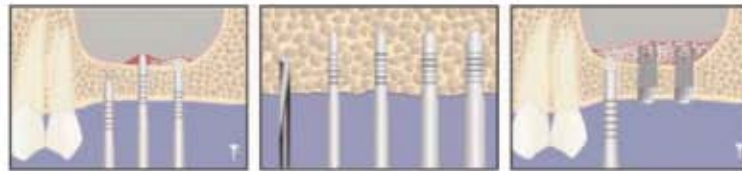
SSI-F-260 SET OF 5 PIECES Coniques

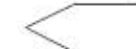

	CONVEXES STRAIGHT	SSI-F-248	2,7 Ømm	3,2 Ømm	3,7 Ømm	4,2 Ømm	5 Ømm
	CONCAVES STRAIGHT	SSI-F-254	2,7 Ømm	3,2 Ømm	3,7 Ømm	4,2 Ømm	5 Ømm
	CONIQUES STRAIGHT	SSI-F-260	2,7 Ømm	3,2 Ømm	3,7 Ømm	4,2 Ømm	5 Ømm

Инструменты для имплантологии
 Implantologie
 Implantologie

Инструменти для имплантології
 Implantologia
 زراعة الأسنان

OSTEOTOME CONVEXES / CONCAVE / CONIQUES





SSI-F-261 SSI-F-262 SSI-F-263 SSI-F-264 SSI-F-265 SSI-F-267 SSI-F-268 SSI-F-269 SSI-F-270 SSI-F-271 SSI-F-273 SSI-F-274 SSI-F-275 SSI-F-276 SSI-F-277

SSI-F-266
SET OF 5 PIECES
 Convexes Curved

SSI-F-272
SET OF 5 PIECES
 Concaves Curved

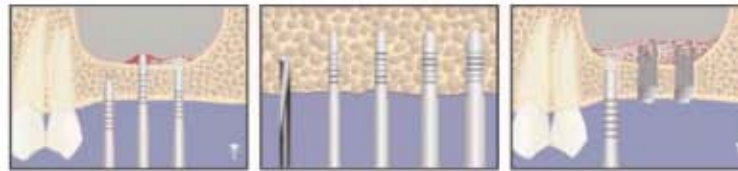
SSI-F-278
SET OF 5 PIECES
 Coniques Curved



	CONVEXES CURVED	SSI-F-266	2,7 Ømm	3,2 Ømm	3,7 Ømm	4,2 Ømm	5 Ømm
	CONCAVES CURVED	SSI-F-272	2,7 Ømm	3,2 Ømm	3,7 Ømm	4,2 Ømm	5 Ømm
	CONIQUES CURVED	SSI-F-278	2,7 Ømm	3,2 Ømm	3,7 Ømm	4,2 Ømm	5 Ømm

- Инструменты для имплантологии
- Implantologie
- Implantologie
- Інструменти для імплантології
- Implantología
- زراعة الأسنان

TREPINE

Burs with depth markings are suited for precise and simple transplantation of cylindrical bone grafts as well as for all other bone-extraction tasks.



- SSI-F-279**
Ø Int. 2 mm
Ø Ext. 3 mm
- SSI-F-280**
Ø Int. 3 mm
Ø Ext. 3.5 mm
- SSI-F-281**
Ø Int. 4 mm
Ø Ext. 5 mm
- SSI-F-282**
Ø Int. 5 mm
Ø Ext. 6 mm
- SSI-F-283**
Ø Int. 6 mm
Ø Ext. 7 mm
- SSI-F-284**
Ø Int. 7 mm
Ø Ext. 8 mm
- SSI-F-285**
Ø Int. 8 mm
Ø Ext. 9 mm
- SSI-F-286**
Ø Int. 9 mm
Ø Ext. 10 mm
- SSI-F-287**
Ø Int. 10 mm
Ø Ext. 11 mm



SSI-F-288
Tissue Punch with pin
Set of 4 Pcs



SSI-F-289
Tissue Punch
Set of 5 Pcs



SSI-F-290
Tissue Punch
Set of 5 Pcs



SSI-F-291
Trephine Drill
Set of 8 Pcs



- Ø2.0mm
- Ø2.5mm
- Ø2.8mm
- Ø3.2mm
- Ø3.65mm
- Ø4.2mm
- Ø5.2mm

SSI-F-292
Short Implant Drills
Set of 3 Pcs

SSI-F-293
Long Implant Drills
Set of 4 Pcs



SSI-F-294
Trephine Drill
Set of 8 Pcs

Инструменты для имплантологии
 Implantologie
 Implantologie

Инструменти для имплантології
 Implantologia
 زراعة الأسنان

BONE SCRAPER STRAIGHT & CURVED



SSI-F-295
Bone Scraper
Straight

SSI-F-296
Bone Scraper
Curved

TISSUE PUNCH STRAIGHT & CURVED



SSI-F-297
2.0mm

SSI-F-298
4.0mm

SSI-F-299
5.0mm

SSI-F-300
6.0mm

SSI-F-301
7.0mm

SSI-F-302
8.0mm

SSI-F-303
2.0mm

SSI-F-304
4.0mm

SSI-F-305
5.0mm

SSI-F-306
6.0mm

SSI-F-307
7.0mm

SSI-F-308
8.0mm

Tissue Punch
Straight

Tissue Punch
Curved



SSI-F-309
Bone Mill



SSI-F-310
Basins For Bone



SSI-F-311
Bone Morselizer Mill Crusher
With Titanium Plates



SSI-F-312
Dental Bur Cleaning
Brush Copper

Инструменты для имплантологии
Implantologie
Implantologie

Инструменти для имплантології
Implantologia
زراعة الأسنان

KEYS FOR IMPLANT SCREW



SSI-F-313



SSI-F-314



SSI-F-315



SSI-F-316

TORQUE WRENCH & RATCHET



SSI-F-317 Star Torque Wrench 6.35mm Universal



SSI-F-318 Round Torque Wrench 4.0mm Universal



SSI-F-319 Hex Driver With 4.0mm Driver



SSI-F-320 Star Torque Wrench 6.35mm Universal



SSI-F-321 Hex Torque Wrench 4.00mm Universal



SSI-F-322 Star Torque Wrench 6.35mm Universal



SSI-F-323 Star Torque Wrench 6.35mm Universal



SSI-F-324 Star Torque Wrench 6.35mm Universal



SSI-F-325 Star Torque Wrench 6.35mm Universal



SSI-F-326 Star Torque Wrench 6.35mm Universal



SSI-F-327 Star Ratchet Wrench 6.35mm Universal



SSI-F-328 Star Ratchet Wrench 6.35mm Universal



SSI-F-329 Star Ratchet Wrench 6.35mm Universal



SSI-F-330 Star Ratchet Wrench 4.0mm Universal



SSI-F-331 Round Ratchet Wrench 4.0mm Universal



SSI-F-332 Round Ratchet Wrench 3.35mm Universal



SSI-F-333 Star Ratchet Wrench 4.0mm Universal



SSI-F-334 Star Ratchet Wrench 6.35mm Universal

Инструменты для имплантологии
Implantologie
Implantologie

Инструменти для имплантології
Implantologia
زراعة الأسنان



SSI-F-335
Bone Crusher
Titanium Metal Cutter
Set of 2 Pcs
Bone Crusher + Mallet

mallet



SSI-F-336
Bone Crusher
Titanium Metal Cutter
Set of 2 Pcs
Bone Crusher + Mallet

mallet



SSI-F-337
Bone Crusher



SSI-F-338
Bone Crusher
Bone Grinding Grain
1.5mm, 2mm, 2.5mm



SSI-F-339
Bone Crusher
Bone Grinding Grain
1.5mm, 2mm, 2.5mm

Инструменты для имплантологии
Implantologie
Implantologie

Инструменти для имплантології
Implantologia
زراعة الأسنان

BONE EXPANDER SCREW & SURGICAL KITS



SSI-F-340
Bone Universal Kit
Drill: 2mm, 2.8mm, 3.2mm, 3.65mm, 4.2mm, 4.5mm, 4.8mm, 5.2mm
Trepines Bit:
3.0mm, 4.0mm, 5.0mm, 6.0mm, 7.0mm, 8.0mm, 9.0mm, 10mm.
Driver:
2.5mm, 2.5mm Hand Pcs
1.25mm, 1.25mm Hand Pcs
Short Driver 2.5mm
Long Driver 2.5mm
1.25mm, Short Hex Driver Hand Pcs
1.25mm, Long Hex Driver Hand Pcs
Torque Wrench 4.0mm



SSI-F-341
Bone Expander Kit
Expander: 2.6mm, 3.0mm, 3.4mm, 3.8mm, 4.3mm
Ratchet Driver
Parallel Pin
Pilot Drill
Drill 1.4mm
Drill Driver 4mm
Hand Driver 4mm
Ratchet 4.0mm



SSI-F-342
Bone Universal Kit
Drill: 2mm, 2.8mm, 3.2mm, 3.65mm, 4.2mm, 4.5mm, 4.8mm, 5.2mm
Trepines Bit:
3.0mm, 4.0mm, 5.0mm, 6.0mm, 7.0mm, 8.0mm, 9.0mm, 10mm.

Bone Compression:
2mm, 3.3mm, 2.8mm, 4.2mm, 3mm, 3.5mm
Driver:
2.5mm, 2.5mm Hand Pcs
1.25mm, 1.25mm Hand Pcs
Short Driver 2.5mm
Long Driver 2.5mm
1.25mm, Short Hex Driver Hand Pcs
1.25mm, Long Hex Driver Hand Pcs
Torque Wrench 6.35mm 1 Pcs



SSI-F-343
Conical Drills: 20 Pcs
Tissue Punches:
3.0mm, 3.50mm, 4.0mm, 4.5mm, 5.0mm, 6.0mm, 6.50mm
Bone Expander:
1.6/3.8mm, 1.9/3.0mm, 2.1/3.6mm, 2.6/3.8mm, 2.9/4.3mm
Drill Adapter: 1 Pcs
1.25mm, 2.50mm Hex Driver Hand Pcs

Pilot Drill: 1.6mm
Drill Bit: 1.4mm, 1.6mm, 1.8mm, 2.0mm, 2.2mm
Ratchet Driver: 4mm/6.35, 1.25/2.50
Rimer: 3.2/4.7mm, 3.7/4.7mm
Parallel Pin: 4.5mm, 2.5mm
Double step Drill: 2.4/2.8mm
Depth Gauge: 1 Pcs
Torque Wrench 6.35mm Universal: 1 Pcs

Инструменты для имплантологии
Implantologie
Implantologie

Инструменти для имплантології
Implantologia
زراعة الأسنان

BONE INJECTORS, COLLECTORS & SUCTION TUBE



SSI-F-344
Ø 2,5mm
Straight / Bend
180mm
I.D 2.5mm
O.D 3.5



SSI-F-345
Ø 3,5mm
Straight / Bend
180mm
I.D 3.5mm
O.D 4.5



SSI-F-346
Ø 4,5mm
Straight / Bend
180mm
I.D 4.5mm
O.D 5.5



SSI-F-347
Ø 6,0mm
Straight / Bend
180mm
I.D 6.0mm
O.D 7.0



SSI-F-348
Ø 2,5mm
170mm
I.D 2.5mm
O.D 3.5



SSI-F-349
Ø 3,5mm
170mm
I.D 3.5mm
O.D 4.5



SSI-F-350
Ø 4,5mm
170mm
I.D 4.5mm
O.D 5.5



SSI-F-351
Ø 6,0mm
170mm
I.D 6.0mm
O.D 7.0



SSI-F-352
Amalgam Gun



SSI-F-353
175mm
Ø 20mm

With Filter



SSI-F-354
180mm
Ø 27mm

With Filter



SSI-F-355
coarse
Ø 5mm



SSI-F-356
fine
Ø 9mm
Suction tubes
to collect
the extracted
bone material
180mm

Инструменты для имплантологии
 Implantologie
 Implantologie

Инструменти для имплантології
 Implantologia
 زراعة الأسنان

1.5mm



SSI-F-357
Suction
Tubes
180mm

3mm



SSI-F-358
Suction
Tubes
180mm

5mm



SSI-F-359
Suction
Tubes
180mm



SSI-F-360
Fig. 6FR
Frazier
150mm - Ø 2 mm

SSI-F-361
Ø 3 mm
length 180mm
SSI-F-362
Ø 4 mm
length 180mm
SSI-F-363
Ø 5 mm
length 180mm



SSI-F-364
Suction Cannula Kit
with 3 Needles



Suction Pipe



Suction Needle
1mm



Suction Needle
1.5mm



Suction Needle
2mm



Оттисковые ложки
Porte-empreinte
Abdrucklöffel

Відбиткові ложки
Cubetas para impresiones
صواني الانطباع

PERFORATED RIM LOCK UPPER



LOWER



All the above impression trays are available in these 5 sizes

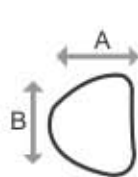

UPPER		U 5	U 4	U 3	U 2	U 1
		XS	S	M	L	XL
A		52	53	54	60	62
B		68	69	73	75	85

LOWER		L 5	L 4	L 3	L 2	L 1
		XS	S	M	L	XL
A		52	53	54	60	62
B		68	69	73	75	85

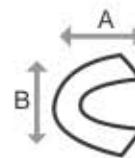

All Dimension are in mm

SOLID RIM LOCK UPPER



LOWER



■ Оттисные ложки
■ Porte-empainte
■ Abdrucklöffel

■ Відбиткові ложки
■ Cubetas para impresiones
■ صواني الانطباع

For Special Packing of Impression Trays Please Ask

Perforated Rim Lock



SET OF 06 PCS
Upper: S, M, L
Lower: S, M, L
SSI-G-021

SET OF 08 PCS
Upper: XS, S, M, L
Lower: XS, S, M, L
SSI-G-022

SET OF 08 PCS
Upper: S, M, L, XL
Lower: S, M, L, XL
SSI-G-023

SET OF 10 PCS
Upper: XS, S, M, L, XL
Lower: XS, S, M, L, XL
SSI-G-024

Solid Rim Lock



SET OF 06 PCS
Upper: S, M, L
Lower: S, M, L
SSI-G-025

SET OF 08 PCS
Upper: XS, S, M, L
Lower: XS, S, M, L
SSI-G-026

SET OF 08 PCS
Upper: S, M, L, XL
Lower: S, M, L, XL
SSI-G-027

SET OF 10 PCS
Upper: XS, S, M, L, XL
Lower: XS, S, M, L, XL
SSI-G-028

IMPRESSION TRAYS

- Оттисные ложки
- Відбиткові ложки
- Porte-empreinte
- Cubetas para impresiones
- Abdrucklöffel
- صواني الانطباع

PERFORATED FULL DENTURE UPPER



LOWER

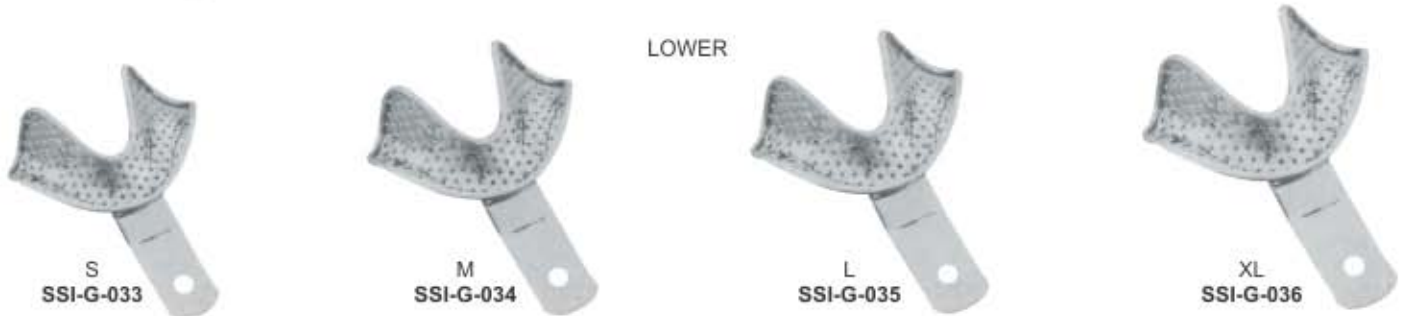

All the above impression trays are available in these 4 sizes

UPPER	UPPER				LOWER	LOWER			
	S	M	L	XL		S	M	L	XL
A	60	64	67	70	A	57	60	60	64
B	70	73	76	79	B	70	70	73	86



All Dimension are in mm



SOLID FULL DENTURE UPPER



PERFORATED FULL DENTURE UPPER
SET OF 06 PCS **SET OF 08 PCS**
 Upper: S, M, L Upper: S, M, L, XL
 Lower: S, M, L Lower: S, M, L, XL
SSI-G-045 **SSI-G-046**

SOLID FULL DENTURE UPPER
SET OF 06 PCS **SET OF 08 PCS**
 Upper: S, M, L Upper: S, M, L, XL
 Lower: S, M, L Lower: S, M, L, XL
SSI-G-047 **SSI-G-048**

 Оттисные ложки
 Porte-empreinte
 Abdrucklöffel

 Відбиткові ложки
 Cubetas para impresiones
 صواني الانطباع

Characteristics:

- 1) Premium Quality Medical Grade AISI 304 Stainless Steel
- 2) Special Designed Joint Less

- 3) Non Welding
- 4) Autoclave Sterilisation at 134°C
- 5) Sand Blast Pattern

PERFORATED UPPER



PERFORATED LOWER



SOLID UPPER



SOLID LOWER



- | | |
|-------------------|----------------------------|
| ■ Оттискные ложки | ■ Відбиткові ложки |
| ■ Porte-empreinte | ■ Cubetas para impresiones |
| ■ Abdrucklöffel | ■ صواني الانطباع |

For Special Packing of Impression Trays Please Ask

Perforated



Characteristics:

- 1) Premium Quality Medical Grade AISI 304 Stainless Steel
- 2) Special Designed Joint Less
- 3) Non Welding
- 4) Autoclave Sterilisation at 134°C
- 5) Sand Blast Pattern

SET OF 06 PCS

Upper: S, M, L
Lower: S, M, L
SSI-G-061

SET OF 08 PCS

Upper: XS, S, M, L
Lower: XS, S, M, L
SSI-G-062

SET OF 08 PCS

Upper: S, M, L, XL
Lower: S, M, L, XL
SSI-G-063

SET OF 10 PCS

Upper: XS, S, M, L, XL
Lower: XS, S, M, L, XL
SSI-G-064

Solid



Characteristics:

- 1) Premium Quality Medical Grade AISI 304 Stainless Steel
- 2) Special Designed Joint Less
- 3) Non Welding
- 4) Autoclave Sterilisation at 134°C
- 5) Sand Blast Pattern

SET OF 06 PCS

Upper: S, M, L
Lower: S, M, L
SSI-G-065

SET OF 08 PCS

Upper: XS, S, M, L
Lower: XS, S, M, L
SSI-G-066

SET OF 08 PCS

Upper: S, M, L, XL
Lower: S, M, L, XL
SSI-G-067

SET OF 10 PCS

Upper: XS, S, M, L, XL
Lower: XS, S, M, L, XL
SSI-G-068

Оттисные ложки
Porte-empreinte
Abdrucklöffel

Відбиткові ложки
Cubetas para impresiones
صواني الانطباع

Special Pattern of Impression Trays
Made of Brass



SET OF 06 PCS

Upper: S, M, L
Lower: S, M, L
SSI-G-069

SET OF 08 PCS

Upper: S, M, L, XL
Lower: S, M, L, XL
SSI-G-070

SET OF 10 PCS

Upper: XS, S, M, L, XL
Lower: XS, S, M, L, XL
SSI-G-071

UPPER



LOWER



- Оттисные ложки
- Відбиткові ложки
- Porte-empreinte
- Cubetas para impresiones
- Abdrucklöffel
- صواني الانطباع

SOLID FULL DENTURE

UPPER



S
SSI-G-078



M
SSI-G-079



L
SSI-G-080



XL
SSI-G-081

LOWER



S
SSI-G-082



M
SSI-G-083



L
SSI-G-084



XL
SSI-G-085

SET OF 06 PCS
Upper: S, M, L
Lower: S, M, L
SSI-G-086

SET OF 08 PCS
Upper: S, M, L, XL
Lower: S, M, L, XL
SSI-G-087

All the above impression trays are available in these 4 sizes

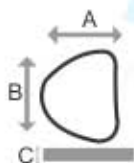

UPPER		S	M	L	XL
	A	60	64	67	70
B	70	73	76	79	



LOWER		S	M	L
	A	57	60	64
B	70	70	73	86

All Dimension are in mm

PERFORATED FULL DENTURE

UPPER



S
SSI-G-088



M
SSI-G-089



L
SSI-G-090



XL
SSI-G-091

LOWER



S
SSI-G-092



M
SSI-G-093



L
SSI-G-094



XL
SSI-G-095

SET OF 06 PCS
Upper: S, M, L
Lower: S, M, L
SSI-G-096

SET OF 08 PCS
Upper: S, M, L, XL
Lower: S, M, L, XL
SSI-G-097

Оттисковые ложки
Porte-empreinte
Abdrucklöffel

Відбиткові ложки
Cubetas para impresiones
صواني الانطباع

UPPER



LOWER



SET OF 06 PCS
Upper: S, M, L
Lower: S, M, L
SSI-G-104

All the above impression trays are available in these 3 sizes

UPPER		U 3	U 2	U 1	LOWER		L 3	L 2	L 1
		S	M	L			S	M	L
	A	57	64	67		A	57	57	60
B	70	71	81	B	76	79	81		

All Dimension are in mm

UPPER



LOWER



SET OF 06 PCS
Upper: S, M, L
Lower: S, M, L
SSI-G-111

IMPRESSION TRAYS

- Оттисковые ложки
- Відбиткові ложки
- Porte-empreinte
- Cubetas para impresiones
- Abdrucklöffel
- صواني الانطباع

English Pattern
Mesh Type



UPPER



LOWER

SET OF 06 PCS

Upper: S, M, L
Lower: S, M, L
SSI-G-120

SET OF 08 PCS

Upper: S, M, L, XL
Lower: S, M, L, XL
SSI-G-121

All the above impression trays are available in these 4 sizes

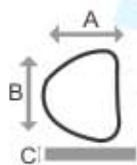

UPPER	U 1	U 2	U 3	U 4
	S	M	L	XL
A	12	13	15	15
B	50	51	55	58
C	67	72	78	80

LOWER	L 1	L 2	L 3	L 4
	S	M	L	XL
A	14	15	15	17
B	50	51	55	60
C	70	77	79	80

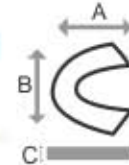

All Dimension are in mm



English Pattern
Punched Type

UPPER



LOWER

SET OF 06 PCS

Upper: S, M, L
Lower: S, M, L
SSI-G-130

SET OF 08 PCS

Upper: S, M, L, XL
Lower: S, M, L, XL
SSI-G-131

Оттисные ложки
Porte-empainte
Abdrucklöffel

Відбиткові ложки
Cubetas para impresiones
صواني الانطباع

ENGLISH PATTERN SOLID TYPE

UPPER



S
SSI-G-132
U1

M
SSI-G-133
U2

L
SSI-G-134
U3

XL
SSI-G-135
U4

LOWER



S
SSI-G-136
L1

M
SSI-G-137
L2

L
SSI-G-138
L3

XL
SSI-G-139
L4

SET OF 06 PCS
Upper: S, M, L
Lower: S, M, L
SSI-G-140

SET OF 08 PCS
Upper: S, M, L, XL
Lower: S, M, L, XL
SSI-G-141

All the above impression trays are available in these 4 sizes

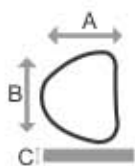

UPPER		U 1	U 2	U 3	U 4
		S	M	L	XL
	A	12	13	15	15
	B	50	51	55	58
	C	67	72	78	80

LOWER		L 1	L 2	L 3	L 4
		S	M	L	XL
	A	14	15	15	17
	B	50	51	55	60
	C	70	77	79	80

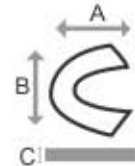

All Dimension are in mm

- | | |
|---|--|
|  Оттисные ложки |  Відбиткові ложки |
|  Porte-empreinte |  Cubetas para impresiones |
|  Abdrucklöffel |  صواني الانطباع |

SOLID FULL DENTURE

UPPER



LOWER



SET OF 06 PCS
Upper: S, M, L
Lower: S, M, L
SSI-G-150

SET OF 08 PCS
Upper: S, M, L, XL
Lower: S, M, L, XL
SSI-G-151

PERFORATED FULL DENTURE

UPPER



LOWER



SET OF 06 PCS
Upper: S, M, L
Lower: S, M, L
SSI-G-160

SET OF 08 PCS
Upper: S, M, L, XL
Lower: S, M, L, XL
SSI-G-161

Оттисные ложки
Porte-empainte
Abdrucklöffel

Відбиткові ложки
Cubetas para impresiones
صواني الانطباع

ORTHODONTIAL SOLID

UPPER



S
SSI-G-162



M
SSI-G-163



L
SSI-G-164



XL
SSI-G-165

LOWER



S
SSI-G-166



M
SSI-G-167



L
SSI-G-168



XL
SSI-G-169

SET OF 06 PCS
Upper: S, M, L
Lower: S, M, L
SSI-G-170

SET OF 08 PCS
Upper: S, M, L, XL
Lower: S, M, L, XL
SSI-G-171

ORTHODONTIAL PERFORATED

UPPER



S
SSI-G-172



M
SSI-G-173



L
SSI-G-174



XL
SSI-G-175

LOWER



S
SSI-G-176



M
SSI-G-177



L
SSI-G-178



XL
SSI-G-179

SET OF 06 PCS
Upper: S, M, L
Lower: S, M, L
SSI-G-180

SET OF 08 PCS
Upper: S, M, L, XL
Lower: S, M, L, XL
SSI-G-181

- Оттисные ложки
- Відбиткові ложки
- Porte-empreinte
- Cubetas para impresiones
- Abdrucklöffel
- صواني الانطباع

PERFORATED WITHOUT RIM LOCK

UPPER



LOWER



SET OF 06 PCS
Upper: S, M, L
Lower: S, M, L
SSI-G-194

SET OF 08 PCS
Upper: XS, S, M, L
Lower: XS, S, M, L
SSI-G-195

SET OF 08 PCS
Upper: S, M, L, XL
Lower: S, M, L, XL
SSI-G-196

SET OF 10 PCS
Upper: XS, S, M, L, XL
Lower: XS, S, M, L, XL
SSI-G-197

SET OF 12 PCS
Upper: XXS, XS, S, M, L, XL
Lower: XXS, XS, S, M, L, XL
SSI-G-198

All the above impression trays are available in these 6 sizes

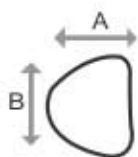

UPPER		U1	U2	U3	U4	U5	U6
	XXS	XS	S	M	L	XL	
A		61	64	66	69	71	73
B		47	51	53	57	60	62

LOWER		L1	L2	L3	L4	L5	L6
	XXS	XS	S	M	L	XL	
A		55	60	72	74	76	78
B		47	49	54	57	59	61

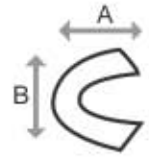

All Dimension are in mm

Оттисные ложки
Porte-empainte
Abdrucklöffel

Відбиткові ложки
Cubetas para impresiones
صواني الانطباع

SOLID WITHOUT RIM LOCK

UPPER



XXS
SSI-G-199
U1

XS
SSI-G-200
U2

S
SSI-G-201
U3

M
SSI-G-202
U4

L
SSI-G-203
U5

XL
SSI-G-204
U6

LOWER



XXS
SSI-G-205
L1

XS
SSI-G-206
L2

S
SSI-G-207
L3

M
SSI-G-208
L4

L
SSI-G-209
L5

XL
SSI-G-210
L6

SET OF 06 PCS
Upper: S, M, L
Lower: S, M, L
SSI-G-211

SET OF 08 PCS
Upper: XS, S, M, L
Lower: XS, S, M, L
SSI-G-212

SET OF 08 PCS
Upper: S, M, L, XL
Lower: S, M, L, XL
SSI-G-213

SET OF 10 PCS
Upper: XS, S, M, L, XL
Lower: XS, S, M, L, XL
SSI-G-214

SET OF 12 PCS
Upper: XXS, XS, S, M, L, XL
Lower: XXS, XS, S, M, L, XL
SSI-G-215

All the above impression trays are available in these 6 sizes

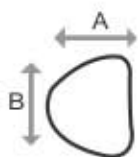

UPPER		U1	U2	U3	U4	U5	U6
		XXS	XS	S	M	L	XL
	A	61	64	66	69	71	73
	B	47	51	53	57	60	62

LOWER		L1	L2	L3	L4	L5	L6
		XXS	XS	S	M	L	XL
	A	55	60	72	74	76	78
	B	47	49	54	57	59	61

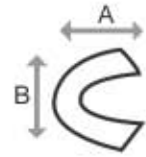

All Dimension are in mm

Оттисные ложки
Porte-empreinte
Abdrucklöffel

Відбиткові ложки
Cubetas para impresiones
صواني الانطباع

PARTIAL SOLID



SSI-G-216 44mm
SSI-G-217 55mm
SSI-G-218 60mm
SSI-G-219 65mm



SSI-G-220



SSI-G-221 44mm
SSI-G-222 55mm
SSI-G-223 60mm
SSI-G-224 65mm



SSI-G-225



SSI-G-226

Set of 5 Pcs **SSI-G-227**

PARTIAL PERFORATED



SSI-G-228 44mm
SSI-G-229 55mm
SSI-G-230 60mm
SSI-G-231 65mm



SSI-G-232



SSI-G-233 44mm
SSI-G-234 55mm
SSI-G-235 60mm
SSI-G-236 65mm



SSI-G-237



SSI-G-238



SSI-G-239



SSI-G-240

Set of 7 Pcs. **SSI-G-241**

IMPRESSION TRAYS

■ Оттисные ложки
■ Porte-empainte
■ Abdrucklöffel

■ Відбиткові ложки
■ Cubetas para impresiones
■ صواني الانطباع



Perforated

1/2L

SSI-G-242 1/2L/S
SSI-G-243 1/2L/M
SSI-G-244 1/2L/L



1/2R

SSI-G-245 1/2R/S
SSI-G-246 1/2R/M
SSI-G-247 1/2R/L



non-Perforated

1/2L

SSI-G-248 1/2L/S
SSI-G-249 1/2L/M
SSI-G-250 1/2L/L



1/2R

SSI-G-251 1/2R/S
SSI-G-252 1/2R/M
SSI-G-253 1/2R/L



Universal

SSI-G-254 UN/1

Front

with swivel handle and fixing screw



Back



Universal

SSI-G-255 UN/1

Front



SSI-G-256 1

Front

with swivel handle



Back



SSI-G-257 1

Front



Stolley

SSI-G-258

ST/1

Partial occlusal stainless steel impression trays

They allow you to take an impression of two semi-arches antagonistic.



with swivel handle and solid

SSI-G-259
OCP



SSI-G-260
OCG

Оттисные ложки
Porte-empainte
Abdrucklöffel

Відбиткові ложки
Cubetas para impresiones
صواني الانطباع



XS
SSI-G-261
U0



S
SSI-G-262
U1



M
SSI-G-263
U2

UPPER



L
SSI-G-264
U3



XL
SSI-G-265
U4

	A mm.	B mm.
U 0	59	52
U 1	66	52
U 2	71	62
U 3	71	64
U 4	80	70

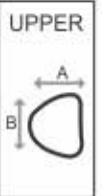

XS
SSI-G-266
L0



S
SSI-G-267
L1



M
SSI-G-268
L2

LOWER



L
SSI-G-269
L3



XL
SSI-G-270
L4

	A mm.	B mm.
L 0	65	46
L 1	67	50
L 2	76	54
L 3	79	56
L 4	79	61

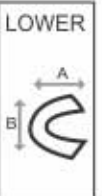

SET OF 10 PCS
Upper: XS, S, M, L, XL
Lower: XS, S, M, L, XL
SSI-G-271

Оттисные ложки
Porte-empreinte
Abdrucklöffel

Відбиткові ложки
Cubetas para impresiones
صواني الانطباع

Ehricke Stainless Steel Impression Trays

UPPER



S
SSI-G-272
U1



M
SSI-G-273
U2



L
SSI-G-274
U3

LOWER



S
SSI-G-275
L1



M
SSI-G-276
L2



L
SSI-G-277
L3

SET OF 06 PCS
Upper: S, M, L
Lower: S, M, L
SSI-G-278

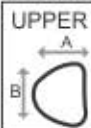
	A mm.	B mm.	UPPER 
U 1	64	46	
U 2	68	53	
U 3	79	61	

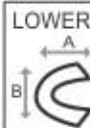
	A mm.	B mm.	LOWER 
L 1	70	48	
L 2	70	53	
L 3	72	57	

Оттисные ложки
Porte-empreinte
Abdrucklöffel

Відбиткові ложки
Cubetas para impresiones
صواني الانطباع

UPPER



S
SSI-G-279
U1



M
SSI-G-280
U2



L
SSI-G-281
U3

LOWER



S
SSI-G-282
L1



M
SSI-G-283
L2



L
SSI-G-284
L3

SET OF 06 PCS

Upper: S, M, L

Lower: S, M, L

SSI-G-285

	A mm.	B mm.
U 1	62	50
U 2	70	56
U 3	78	62

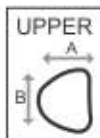

	A mm.	B mm.
L 1	70	55
L 2	78	59
L 3	86	63

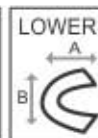





Scalers Tray
SSI-H-001 200 x 100 mm



Scalers Trays
SSI-H-002 205 x 115 x 17 mm
SSI-H-003 205 x 152 x 17 mm
SSI-H-004 290 x 115 x 17 mm



Instruments Trays
SSI-H-005 200 x 110 x 30 mm
SSI-H-006 215 x 115 x 35 mm
SSI-H-007 220 x 130 x 30 mm
SSI-H-008 230 x 125 x 35 mm
SSI-H-009 245 x 140 x 40 mm
SSI-H-010 285 x 160 x 45 mm
SSI-H-011 315 x 175 x 50 mm
SSI-H-012 330 x 185 x 50 mm



Instruments Trays
SSI-H-013 150 x 100 x 50 mm
SSI-H-014 200 x 100 x 50 mm
SSI-H-015 220 x 120 x 50 mm
SSI-H-016 240 x 140 x 50 mm
SSI-H-017 200 x 150 x 50 mm
SSI-H-018 250 x 200 x 50 mm
SSI-H-019 300 x 250 x 50 mm
SSI-H-020 300 x 200 x 50 mm
SSI-H-021 350 x 250 x 50 mm
SSI-H-022 400 x 300 x 50 mm
SSI-H-023 450 x 300 x 50 mm
SSI-H-024 450 x 350 x 50 mm



Instruments Trays With Lid
SSI-H-025 150 x 100 x 50 mm
SSI-H-026 200 x 100 x 50 mm
SSI-H-027 220 x 120 x 50 mm
SSI-H-028 240 x 140 x 50 mm
SSI-H-029 200 x 150 x 50 mm
SSI-H-030 250 x 200 x 50 mm
SSI-H-031 300 x 250 x 50 mm
SSI-H-032 300 x 200 x 50 mm
SSI-H-033 350 x 250 x 50 mm
SSI-H-034 400 x 300 x 50 mm
SSI-H-035 450 x 300 x 50 mm
SSI-H-036 450 x 350 x 50 mm



Mayo Tray Perforated
SSI-H-037 150 x 100 x 25 mm
SSI-H-038 200 x 100 x 25 mm
SSI-H-039 220 x 120 x 25 mm
SSI-H-040 240 x 140 x 25 mm
SSI-H-041 200 x 150 x 25 mm
SSI-H-042 250 x 200 x 25 mm
SSI-H-043 300 x 250 x 25 mm
SSI-H-044 300 x 200 x 25 mm
SSI-H-045 350 x 250 x 25 mm
SSI-H-046 400 x 300 x 25 mm
SSI-H-047 450 x 300 x 25 mm
SSI-H-048 450 x 350 x 25 mm



Scaler Tray
SSI-H-049 200 x 115 mm
SSI-H-050 205 x 150 mm
SSI-H-051 290 x 150 mm
SSI-H-052 300 x 200 mm



Instruments Tray Perforated
SSI-H-053 150 x 100 x 50 mm
SSI-H-054 200 x 100 x 50 mm
SSI-H-055 220 x 120 x 50 mm
SSI-H-056 240 x 140 x 50 mm
SSI-H-057 200 x 150 x 50 mm
SSI-H-058 250 x 200 x 50 mm
SSI-H-059 300 x 250 x 50 mm
SSI-H-060 300 x 200 x 50 mm
SSI-H-061 350 x 250 x 50 mm
SSI-H-062 400 x 300 x 50 mm
SSI-H-063 450 x 300 x 50 mm
SSI-H-064 450 x 350 x 50 mm

SSSMILE
SURE

Sterilizing boxes & instruments Trays



Instruments Box with Hooks

- SSI-H-065** 170 x 70 x 30 mm
- SSI-H-066** 180 x 80 x 40 mm
- SSI-H-067** 200 x 100 x 40 mm
- SSI-H-068** 200 x 100 x 50 mm
- SSI-H-069** 220 x 120 x 50 mm
- SSI-H-070** 250 x 150 x 50 mm
- SSI-H-071** 250 x 200 x 50 mm
- SSI-H-072** 300 x 150 x 60 mm
- SSI-H-073** 300 x 200 x 50 mm
- SSI-H-074** 350 x 250 x 50 mm
- SSI-H-075** 400 x 200 x 100 mm
- SSI-H-076** 450 x 250 x 50 mm



Instruments Box

- SSI-H-077** 170 x 70 x 30 mm
- SSI-H-078** 180 x 80 x 40 mm
- SSI-H-079** 200 x 100 x 40 mm
- SSI-H-080** 200 x 100 x 50 mm
- SSI-H-081** 220 x 120 x 50 mm
- SSI-H-082** 250 x 150 x 50 mm
- SSI-H-083** 250 x 200 x 50 mm
- SSI-H-084** 300 x 150 x 60 mm
- SSI-H-085** 300 x 200 x 50 mm
- SSI-H-086** 350 x 250 x 50 mm
- SSI-H-087** 400 x 200 x 100 mm
- SSI-H-088** 450 x 250 x 50 mm



Instruments Box Perforated

- SSI-H-089** 170 x 70 x 30 mm
- SSI-H-090** 180 x 80 x 40 mm
- SSI-H-091** 200 x 100 x 40 mm
- SSI-H-092** 200 x 100 x 50 mm
- SSI-H-093** 220 x 120 x 50 mm
- SSI-H-094** 250 x 150 x 50 mm
- SSI-H-095** 250 x 200 x 50 mm
- SSI-H-096** 300 x 150 x 60 mm
- SSI-H-097** 300 x 200 x 50 mm
- SSI-H-098** 350 x 250 x 50 mm
- SSI-H-099** 400 x 200 x 100 mm
- SSI-H-100** 450 x 250 x 50 mm



Gloves Box

- SSI-H-101** 300 x 150 mm



Catheters Tray with lid

- SSI-H-102** 200 x 60 x 40 mm
- SSI-H-103** 200 x 90 x 40 mm
- SSI-H-104** 320 x 95 x 50 mm
- SSI-H-105** 328 x 90 x 50 mm
- SSI-H-106** 365 x 90 x 50 mm
- SSI-H-107** 440 x 115 x 50 mm



Box With Filter

- SSI-H-108** 100 x 50 mm
- SSI-H-109** 250 x 150 mm
- SSI-H-110** 150 x 65 mm
- SSI-H-111** 200 x 100 mm
- SSI-H-112** 300 x 200 mm



Instruments Trays With Cover

- SSI-H-113** 210 x 110 x 50 mm
- SSI-H-114** 240 x 160 x 50 mm
- SSI-H-115** 300 x 180 x 50 mm
- SSI-H-116** 360 x 210 x 50 mm
- SSI-H-117** 400 x 230 x 55 mm

Instruments Trays Without Cover

- SSI-H-118** 210 x 110 x 50 mm
- SSI-H-119** 240 x 160 x 50 mm
- SSI-H-120** 300 x 180 x 50 mm
- SSI-H-121** 360 x 210 x 50 mm
- SSI-H-122** 400 x 230 x 55 mm



Instruments Box with lid

- SSI-H-123** 170 x 70 x 30 mm
- SSI-H-124** 180 x 80 x 40 mm
- SSI-H-125** 200 x 100 x 40 mm
- SSI-H-126** 200 x 100 x 50 mm
- SSI-H-127** 220 x 120 x 50 mm
- SSI-H-128** 250 x 150 x 50 mm
- SSI-H-129** 250 x 200 x 50 mm
- SSI-H-130** 300 x 150 x 60 mm
- SSI-H-131** 300 x 200 x 50 mm
- SSI-H-132** 350 x 250 x 50 mm
- SSI-H-133** 400 x 200 x 100 mm
- SSI-H-134** 450 x 250 x 50 mm



Kidney Tray
 SSI-H-135 160 mm
 SSI-H-136 200 mm
 SSI-H-137 250 mm
 SSI-H-138 280 mm
 SSI-H-139 300 mm



Kidney Tray Shallow
 SSI-H-140 170 mm
 SSI-H-141 220 mm
 SSI-H-142 240 mm



Kidney Tray With Cover
 SSI-H-143 160 mm
 SSI-H-144 200 mm
 SSI-H-145 250 mm
 SSI-H-146 280 mm
 SSI-H-147 300 mm



Kidney Tray
 SSI-H-148 160 mm
 SSI-H-149 200 mm
 SSI-H-150 250 mm
 SSI-H-151 280 mm
 SSI-H-152 300 mm



Forceps Jars
 SSI-H-153 30 x 90 mm
 SSI-H-154 50 x 100 mm
 SSI-H-155 50 x 130 mm
 SSI-H-156 50 x 175 mm
 SSI-H-157 75 x 100 mm
 SSI-H-158 75 x 130 mm
 SSI-H-159 75 x 175 mm
 SSI-H-160 100 x 175 mm
 SSI-H-161 100 x 200 mm



Methot Jar Without Lid
 SSI-H-162



Dressing Jar / Cotton Container
 SSI-H-163 80 x 80 mm
 SSI-H-164 100 x 60 mm
 SSI-H-165 100 x 80 mm
 SSI-H-166 100 x 100 mm
 SSI-H-167 120 x 80 mm
 SSI-H-168 120 x 100 mm
 SSI-H-169 150 x 100 mm
 SSI-H-170 150 x 150 mm
 SSI-H-171 180 x 150 mm
 SSI-H-172 180 x 180 mm
 SSI-H-173 200 x 200 mm
 SSI-H-174 240 x 240 mm



Sputum Cup
 SSI-H-175



Dressing Jar With Lid & Knob
 SSI-H-176 80 x 80 mm
 SSI-H-177 90 x 90 mm
 SSI-H-178 100 x 100 mm
 SSI-H-179 120 x 120 mm
 SSI-H-180 100 x 130 mm
 SSI-H-181 150 x 150 mm
 SSI-H-182 125 x 170 mm



Round Bowls
 SSI-H-183 80 x 35 mm
 SSI-H-184 125 x 60 mm



Spirit Lamp
SSI-H-185



Spirit Lamp
SSI-H-186



Spirit Lamp
SSI-H-187



Cotton Holding Jar
SSI-H-188



Cotton Holder
SSI-H-189



Cotton Holder
SSI-H-190



Cotton Wool Dispenser Acc.
to Methot
SSI-H-191



Needle Sterillization Tub
SSI-H-192



Round Endodontic Boxes
complete with lid
SSI-H-193 Ø mm. 94 - h. mm. 70



Endodontic Box
SSI-H-194



SSI-H-195
100 x 180 x 11mm
Mini size



SSI-H-196
100 x 180 x 11mm
Mini size



SSI-H-197
100 x 180 x 11mm
Mini size



SSI-H-198
100 x 180 x 11mm
Mini size



SSI-H-199
100 x 180 x 11mm
Mini size



Lid
Coperchio
SSI-H-200
103 x 182 x 10mm
Mini size



SSI-H-201
Silver

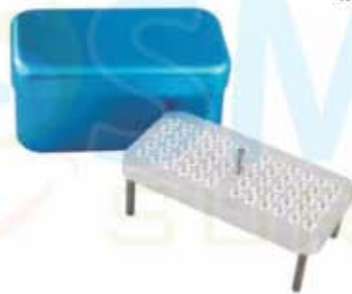

SSI-H-202 Blue
SSI-H-203 Red



SSI-H-204 Blue
SSI-H-205 Red



SSI-H-206
Silver



SSI-H-207
Green



SSI-H-209
Blue



SSI-H-208
Golden



SSI-H-210
Red



SSI-H-211
Silver



SSI-H-212
Midi
125 x 105 x 54mm



SSI-H-213
Maxi
204 x 105 x 54mm

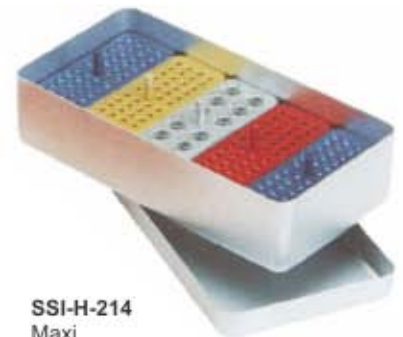

SSI-H-214
Maxi
204 x 105 x 54mm



Round Sterilizer Drum

- SSI-H-215 mm. Ø 80 x 80 H
- SSI-H-216 mm. Ø 125 x 80 H
- SSI-H-217 mm. Ø 125 x 100 H
- SSI-H-218 mm. Ø 125 x 125 H
- SSI-H-219 mm. Ø 150 x 80 H
- SSI-H-220 mm. Ø 150 x 100 H
- SSI-H-221 mm. Ø 150 x 130 H
- SSI-H-222 mm. Ø 150 x 150 H
- SSI-H-223 mm. Ø 150 x 190 H
- SSI-H-224 mm. Ø 190 x 125 H
- SSI-H-225 mm. Ø 190 x 145 H
- SSI-H-226 mm. Ø 190 x 165 H
- SSI-H-227 mm. Ø 190 x 190 H
- SSI-H-228 mm. Ø 190 x 240 H
- SSI-H-229 mm. Ø 190 x 290 H
- SSI-H-230 mm. Ø 240 x 120 H
- SSI-H-231 mm. Ø 240 x 145 H
- SSI-H-232 mm. Ø 240 x 165 H
- SSI-H-233 mm. Ø 240 x 190 H
- SSI-H-234 mm. Ø 240 x 240 H
- SSI-H-235 mm. Ø 240 x 290 H
- SSI-H-236 mm. Ø 240 x 340 H
- SSI-H-237 mm. Ø 240 x 390 H
- SSI-H-238 mm. Ø 290 x 145 H
- SSI-H-239 mm. Ø 290 x 165 H
- SSI-H-240 mm. Ø 290 x 190 H
- SSI-H-241 mm. Ø 290 x 240 H
- SSI-H-242 mm. Ø 290 x 290 H
- SSI-H-243 mm. Ø 290 x 340 H
- SSI-H-244 mm. Ø 290 x 390 H
- SSI-H-245 mm. Ø 340 x 145 H
- SSI-H-246 mm. Ø 340 x 165 H
- SSI-H-247 mm. Ø 340 x 190 H
- SSI-H-248 mm. Ø 340 x 240 H
- SSI-H-249 mm. Ø 340 x 290 H
- SSI-H-250 mm. Ø 340 x 340 H
- SSI-H-251 mm. Ø 340 x 390 H
- SSI-H-252 mm. Ø 390 x 140 H
- SSI-H-253 mm. Ø 390 x 165 H
- SSI-H-254 mm. Ø 390 x 190 H
- SSI-H-255 mm. Ø 390 x 240 H
- SSI-H-256 mm. Ø 390 x 290 H
- SSI-H-257 mm. Ø 390 x 340 H
- SSI-H-258 mm. Ø 390 x 390 H
- SSI-H-259 mm. Ø 390 x 490 H

Round Sterilizer Drums "Filter"

- SSI-H-260 mm. Ø 80 x 80 H
- SSI-H-261 mm. Ø 125 x 80 H
- SSI-H-262 mm. Ø 125 x 100 H
- SSI-H-263 mm. Ø 125 x 125 H
- SSI-H-264 mm. Ø 150 x 100 H
- SSI-H-265 mm. Ø 150 x 130 H
- SSI-H-266 mm. Ø 150 x 150 H
- SSI-H-267 mm. Ø 150 x 190 H
- SSI-H-268 mm. Ø 190 x 145 H
- SSI-H-269 mm. Ø 190 x 165 H
- SSI-H-270 mm. Ø 190 x 190 H
- SSI-H-271 mm. Ø 190 x 240 H
- SSI-H-272 mm. Ø 240 x 145 H
- SSI-H-273 mm. Ø 240 x 165 H
- SSI-H-274 mm. Ø 240 x 190 H
- SSI-H-275 mm. Ø 240 x 240 H
- SSI-H-276 mm. Ø 240 x 290 H
- SSI-H-277 mm. Ø 240 x 340 H
- SSI-H-278 mm. Ø 240 x 390 H
- SSI-H-279 mm. Ø 290 x 145 H
- SSI-H-280 mm. Ø 290 x 165 H
- SSI-H-281 mm. Ø 290 x 190 H
- SSI-H-282 mm. Ø 290 x 240 H
- SSI-H-283 mm. Ø 290 x 290 H
- SSI-H-284 mm. Ø 290 x 340 H
- SSI-H-285 mm. Ø 290 x 390 H
- SSI-H-286 mm. Ø 340 x 145 H
- SSI-H-287 mm. Ø 340 x 165 H
- SSI-H-288 mm. Ø 340 x 190 H
- SSI-H-289 mm. Ø 340 x 240 H
- SSI-H-290 mm. Ø 340 x 290 H
- SSI-H-291 mm. Ø 390 x 140 H
- SSI-H-292 mm. Ø 390 x 165 H
- SSI-H-293 mm. Ø 390 x 190 H
- SSI-H-294 mm. Ø 390 x 240 H
- SSI-H-295 mm. Ø 390 x 290 H
- SSI-H-296 mm. Ø 390 x 340 H
- SSI-H-297 mm. Ø 390 x 490 H

Round Bowls With Cover

- SSI-H-298 Ø 40 mm ml.30
- SSI-H-299 Ø 60 mm ml.50
- SSI-H-300 Ø 80 mm ml.150
- SSI-H-301 Ø 100 mm ml.250
- SSI-H-302 Ø 120 mm ml.450
- SSI-H-303 Ø 150 mm ml.750
- SSI-H-304 Ø 180 mm ml.1500
- SSI-H-305 Ø 200 mm ml.2100
- SSI-H-306 Ø 250 mm ml.3500

Round Bowls With Out Cover

- SSI-H-307 Ø 40 mm ml.30
- SSI-H-308 Ø 60 mm ml.50
- SSI-H-309 Ø 80 mm ml.150
- SSI-H-310 Ø 100 mm ml.250
- SSI-H-311 Ø 120 mm ml.450
- SSI-H-312 Ø 150 mm ml.750
- SSI-H-313 Ø 180 mm ml.1500
- SSI-H-314 Ø 200 mm ml.2100
- SSI-H-315 Ø 250 mm ml.3500

INSTRUMENTS MANAGEMENT SYSTEM

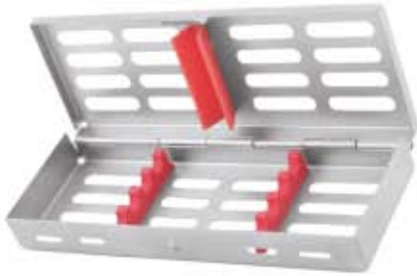

**Cassette For 4 Instruments
SSI-H-316**



**Cassette For 5 Instruments
SSI-H-317**



**Cassette For 6 Instruments
SSI-H-318**



**Cassette For 7 Instruments
SSI-H-319**



**Cassette For 10 Instruments
SSI-H-320**



**Cassette For 20 Instruments
SSI-H-321**



**Cassette For Extraction Forceps
SSI-H-322**



**Cassette For Root Elevator
SSI-H-323**



**SSI-H-324
Cassette Tray
15 Pcs**



**SSI-H-325
Cassette Tray
15 Pcs**

STERILIZING MESH TRAY

Different sizes & dimensions are available at buyer's demand



MESH TRAYS
SSI-H-326
Different sizes & dimensions are available at buyer's demand



MESH TRAYS
SSI-H-327
05 Pcs



MESH TRAYS
SSI-H-328
07 Pcs



MESH TRAYS
SSI-H-329
10 Pcs



MESH TRAYS
SSI-H-330
20 Pcs



SSI-H-331
Mesh Cassettes
5 Pieces, 7 Pieces, 10 Pieces,
15 Pieces & 20 Pieces



MESH TRAY
SSI-H-332 240x130x50mm
SSI-H-333 240x130x60mm
SSI-H-334 240x250x50mm
SSI-H-335 240x250x60mm
SSI-H-336 480x250x50mm
SSI-H-337 480x250x60mm
SSI-H-338 480x250x70mm



MESH TRAY
SSI-H-339 240x250x 50mm
SSI-H-340 240x250x 60mm
SSI-H-341 240x250x 70mm
SSI-H-342 480x250x 50mm
SSI-H-343 480x250x 60mm
SSI-H-344 480x250x 70mm
SSI-H-345 480x250x100mm



MESH TRAY
SSI-H-346 240x250x50mm
SSI-H-347 240x250x60mm
SSI-H-348 240x250x70mm
SSI-H-349 280x250x50mm
SSI-H-350 280x250x60mm



MESH TRAY
SSI-H-351 280x250x 70mm
SSI-H-352 280x250x100mm
SSI-H-353 280x250x 50mm
SSI-H-354 280x280x 60mm
SSI-H-355 280x280x 70mm
SSI-H-356 300x280x 60mm



SSI-H-357
18×7×3.5cm
5 Instruments Cassette
Detachable Lids
+
5 Instruments Cassette Hinged
Lids with button Lock



SSI-H-358
29×18.5×3.5cm
20 Instruments Cassette Hinged
Lids with surgical kit fitting,
button lock



Instruments Cassette
SSI-H-359 5 Pieces Cassette
SSI-H-360 7 Pieces Cassette
SSI-H-361 10 Pieces Cassette



SSI-H-362
18×11×3.5cm
Extra large cassette for 6
Instruments, with compartment
for small parts hinged lids



SSI-H-363
29×18.5×3.5cm
20 Instruments Cassette
Detachable Lids
+
20 Instruments Cassette Hinged
Lids with button Lock



SSI-H-364
10×13×2.2cm
10 Instruments Cassette Hinged
Lids, Click Lock Available in 2
designs



SSI-H-365
29×18.5×3.5cm
20 Instruments Cassette Detachable
Lids with elevator fitting
+
20 Instruments Cassette Hinged
Lids with elevator fitting , button lock

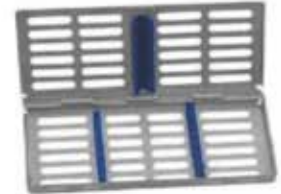

SSI-H-366
18×9×2.2cm
7 Instruments Cassette Hinged
Lids, Click Lock, Available in 2
designs



SSI-H-367
21×14×3.5cm
15 Instruments cassette,
Detachable lids, button lock



SSI-H-368
21×14×3.5cm
15 Instruments cassette,
detachable lids, button
lock, with fitting of micro
surgery kit



SSI-H-369
21×14×4.5cm
8 pcs luxator/elevator
cassette, Detach0
ablelids, button lock



SSI-H-370
15×9×5cm
Box for dental implant tools and
surgical kits, Capacity:8
tools, 18 tools, 24 Tools, 58 Tools
+ removable compartment



Instruments Tray Perforated
SSI-H-371 288 x 187 x 40 mm



Instruments Tray Perforated Base
SSI-H-372 288 x 187 x 40 mm



Instruments Tray Solid Base
SSI-H-373 288 x 187 x 40 mm

DESCRIPTION	PAGE#
A	
A COSMETIC CONTOURING	284
ABOU-RASS EXPLORERS	117
ACUTE LIFT ELEVATOR	288
ADAMS PLIER	255
ADAMS PLIERS FOR HOOKS AND BENDING WIRE	269
ADERER CLAMP THREE JAW WIRE BENDING PLIER	269
ADERER FACEBOW LOOP FORMING PLIERS	259
ADERER LARGE WIRE BENDING AND LOOP FORMING PLIERS	254
ADERER PLIER	254
ADHESIVE REMOVING PLIERS	263
ADHESIVE REMOVING PLIERS T.C	267
ADSON / MICRO-ADSON TWEEZERS	110
ADSON BROWN TWEEZERS	109
ADSON CARBIDE TIPPED TISSUE FORCEPS	304
ADSON NEEDLE HOLDERS	222
ADSON T.C TWEEZERS	110
ADSON TISSUE FORCEPS	304
ADSON TWEEZERS	109, 111
ADSON WITH TEETH TWEEZERS	108
ADSON-BROWN TWEEZERS	110
ADSON-TC TWEEZERS	109
ALBRECHT LUXATION FORCEPS	30
ALGINATE & PLASTER SPATULAS	191
ALLEN PERIODONTAL INSTRUMENTS	238
ALLIS 4:5 STERILIZING & TISSUE CLAMPS	218
ALLIS 6:7 STERILIZING & TISSUE CLAMPS	218
ALLIS-BABY 3:4 STERILIZING & TISSUE CLAMPS	218
ALL-PURPOSE PLIERS	221
ALLUMINIUM CALIPER	279
AMALGAM AND PLASTIC FILLING INSTRUMENTS	128-130
AMALGAM GUN	313
AMALGAM INSTRUMENTS	165, 233-234
AMALGAM INSTRUMENTS AND BURNISHERS	131-132
AMALGAM WELL	234
AMALGAM WELL LARGE MATRIX RETAINERS	231
AMALGAM WELL MATRIX RETAINERS	231
AMALGAM WELL MEDIUM MATRIX RETAINERS	231
AMSTERDAM TWEEZERS	106
ANGLE PLIER	254
ANISWORTH RUBBER DAM CLAMPS FORCEPS	224
ANTERIOR SINGLE ENDED	126
ANTKOVIK WAX KNIVES	190
ANVIL DENTAL LABORATORY INSTRUMENT	196
APEX FORCEPS	37
APEX FORCEPS LOWER ROOT EXTRACTING FORCEPS	36
APEXO ROOT ELEVATOR	74, 80
APICAL ROOT ELEVATORS	76
APICAL ROOT ELEVATORS SET OF 2 PCS	94
APPLICATER PERIODONTAL INSTRUMENTS	137
ARCH BENDING PLIERS	264
ARCH COUNTING PLIER	256
ARROW CLASP FORMING PLIERS	260
ARTICULATORS	194-196
ATRAUMATIC EXTRACTION BAYONET ROOT ELEVATORS	87-88
AUSTIN TISSUE RETRACTORS	204
B	
B COSMETIC CONTOURING	284
BABY EXTRACTING FORCEPS SET OF 07 PCS (RAINBOW COATING)	27
BABY EXTRACTING FORCEPS SET OF 07 PCS	27
BABY TOOTH EXTRACTION FORCEPS SET OF 7 PIECES	26
BACKHAUS HAEMOSTATIC FORCEPS	217

DESCRIPTION	PAGE#
BACKHAUS NOT-PERFORATING TOWEL CLAMPS	217
BALL BURNISHERS	131
BALL FILLING INSTRUMENTS	135-136
BAND REMOVING PLIER	257
BAND REMOVING PLIERS T.C	267
BAND SEATER AUTO CLEAVABLE	253
BAND SEATER AUTO CLEAVABLE ROUND SHAPE	253
BAND SEATER AUTO CLEAVABLE TRIANGLE SHAPE	253
BAND SEATING & REMOVING INSTRUMENTS	253
BAND SEATING & REMOVING SILICON GRIP	253
BAND SEATING PLIERS	263
BARRAQUER NEEDLE HOLDERS	221
BASINS FOR BONE	309
BAUMGARTER NEEDLE HOLDERS	219, 222
BAYONET ELEVATOR	88
BAYONET ROOTS ELEVATOR	89
BAYONET ROOTS ELEVATOR SET	81
BEALE WAX AND MODELLING CARVERS	186
BEEBEE CROWN SCISSORS	211
BEEBEE GUM SCISSORS	213
BEERENDONK MINI GAUGE	279
BEIN ROOT ELEVATOR	72,75,84-85
BEIN ROOT ELEVATORS SET OF 3 PCS	94
BEIN ROOTS ELEVATOR	83, 86
BENDING PLIER	269
BENNET PLASTIC FILLING INSTRUMENTS	134
BERNARD BAYONET ELEVATOR OFFSET RIGHT	88
BERTEN ROOT ELEVATOR	72, 84
BEYER BONE ROUNGER	245-246
BIRD BEAK PLIER	263, 269
BIRD'S BEAK CLAW WITH CUTTER	261
BISHOP HARMAN MICRO TISSUE FORCEP	305
BLACK ENAMEL INSTRUMENTS	146
BLACK HATCHES	146
BLACK TITANIUM COLOUR COATED INSTRUMENTS	281-285
BLADE AND PUSHER	297
BLUE PLASMA COATING & OPERATIVE INSTRUMENTS	142
BLUMENTHAL 45° BONE ROUNGER	244
BLUMENTHAL 90° BONE ROUNGER	244
BLUMENTHAL BONE ROUNGER	244
BOGHOSIANIMPLANTOLOGY	282
BÖHM PLIERS FOR TELESCOPE CROWNS	247
BOLEY GAUGE	279
BONE BRACKET GAUGE	249
BONE CARRIER	295
BONE CRUSHER + MALLET	311
BONE CRUSHER + MALLET/MALLET	311
BONE CRUSHER	311
BONE CRUSHER TITANIUM METAL CUTTER SET OF 2 PCS	311
BONE CURETTES	181
BONE EXPANDER KIT	312
BONE EXPANDER SCREW & SURGICAL KITS	312
BONE FILE	179
BONE FILES	235
BONE GRAFT/CARRIER	299
BONE GRAFTING INSTRUMENTS	297-298
BONE GRAFTING INSTRUMENTS COMPACTOR /TAMPERS	296
BONE INJECTORS, COLLECTORS & SUCTION TUBE	313
BONE MILL	309
BONE MORSELIZER MILL CRUSHER	309
BONE ROUNGER	244-246
BONE SCRAPER	309
BONE SCRAPER STRAIGHT & CURVED	309
BONE SPLITTING CHISELS	236

DESCRIPTION	PAGE#	DESCRIPTION	PAGE#
BONE SPOON/ PACKER	296	CLEOIDS	145
BONE THICKNESS GAUGE	249, 278	CLEVELAND BONE ROUNGER	245
BONE UNIVERSAL KIT	312	COARSE SUCTION TUBE	313
BOX WITH FILTER	335	COHEN TISSUE NIPPER	246
BOYNTON NEEDLE HOLDERS	223	COHEN UNIVERSAL FORCEPS	52
BRACKET PLACER TWEEZERS	250	COLEMAN ROOT ELEVATOR	82
BRACKET REMOVING PLIER	258	COLLEGE TWEEZERS	107
BRACKET REMOVING PLIERS ANGLED T.C	267	COLLINS TONGUE FORCEPS	217
BRACKET REMOVING PLIERS STRAIGHT T.C	267	COLUMBIA PERIODONTAL INSTRUMENTS	122, 140
BRACKET REMOVING PLIERS WITH PLASTIC TIP T.C	267	COLUMBIA PERIODONTAL INSTRUMENTS SET	122
BRACKET TWEEZERS SLOT ALIGNER	250	COLUMBIA RETRACTORS	203
BREWER RUBBER DAM CLAMPS FORCEPS	224	COMELLAS FORCEPS ANATOMICAL HANDLE	66
BROWN TWEEZERS	110	COMPACTOR	298
BRUNINGS CHEEK RETRACTOR	203	COMPASSO DE WILLIS	249
BUCCAL DENTAL PHOTOGRAPHIC MIRRORS	197	COMPOSITE GOLD COATED INSTRUMENTS	135
BUCCAL-SMALL DENTAL PHOTOGRAPHIC MIRRORS	197	COMPOSITE GOLD TIP INSTRUMENTS	136
BUCK PERIODONTAL KNIVES	176	COMPOSITE INSTRUMENTS	139
BUCK STRAIGHT FILE	156-157	COMPOSITE INSTRUMENTS BLUE TITANIUM WITH CASSETTES	184
BUFFALO PLASTER KNIFE	189	COMPOSITE INSTRUMENTS TITANIUM BLUE ENDODONTIC	184
BURNISHER BURNISHERS	283	COMPOSITE PACKING INSTRUMENT	284
BURNISHER PERIODONTAL INSTRUMENTS	137	COMPRESSOR DOUBLE FLASK	192
BURNISHERS	283	COMPRESSOR SINGLE FLASK	192
BUSCH EXTRACTING FORCEPS (ENGLISH PATTERN)	24	CONDENSER IMPLANTOLOGY	289
BUSER PERIODONTAL INSTRUMENTS	238	CONE-SOCKET FRONT SURFACE MOUTH MIRRORS	104
C		CONE-SOCKET MAGNIFYING MOUTH MIRRORS	103
C COSMETIC CONTOURING	284	CONE-SOCKET MIRROR HANDLE	105
CARBIDE TIP EXTRACTION FORCEPS	39	CONE-SOCKET PLAIN MOUTH MIRRORS	103
CARBIDE TIPPED ROOT TIP FORCEPS	38	CONE-SOCKET RHODIUM MOUTH MIRRORS	104
CARRY FORCEPS	305	CONTOURING INSTRUMENT	282
CARVERS INSTRUMENTS	143-145, 187	CONTOURING PLIER	256, 269
CASSETTE FOR 10 INSTRUMENTS	340	COTTON HOLDER	337
CASSETTE FOR 20 INSTRUMENTS	340	COTTON HOLDING JAR	337
CASSETTE FOR 4 INSTRUMENTS	340	COTTON MERIAM TWEEZER SET OF 10 PIECES.	155
CASSETTE FOR 5 INSTRUMENTS	340	COTTON WOOL DISPENSER ACC.	337
CASSETTE FOR 6 INSTRUMENTS	340	COUPLAND BONE CHEISL	94
CASSETTE FOR 7 INSTRUMENTS	340	COUPLAND ROOT ELEVATOR SET OF 6	93
CASSETTE FOR EXTRACTION FORCEPS	340	COUPLAND ROOT ELEVATORS	76
CASSETTE FOR ROOT ELEVATOR	340	CRANE KAPLAN PERIODONTAL INSTRUMENTS	140
CASSETTE TRAY 15 PCS	340	CRANE KAPLAN PERIODONTAL KNIVES	176
CASTROVIEJO CALIPERS	277	CRANE KAPLAN TWEEZERS	109
CASTROVIEJO GUM SCISSORS	210	CRANE-KAPLAN PERIODONTAL INSTRUMENTS	169, 172
CASTROVIEJO MEASURING LOOP	278	CRILE-RYDER T.C NEEDLE HOLDERS	219
CASTROVIEJO MICRO SCISSORS	214	CRILE-WOOD NEEDLE HOLDERS	219, 222
CASTROVIEJO NEEDLE HOLDERS	220-222	CROWN & SHELL PLIER	257
CATHETERS TRAY WITH LID	335	CROWN PLIER	247
CATTONI PROBE	118	CROWN REMOVER	228-229, 247
CEMENT SPATULA	153, 155, 185-186	CROWN SCISSORS	211
CERAMIC COATED HANDLE	167	CROWN SPREADERS	229
CERI SAW	248	CRUCIBLE TONGS	248
CHALAZION MUCOCELE FORCEPS	304	CRYER EXTRACTING FORCEPS (AMERICAN PATTERN)	49
CHEATLE STERILIZING & TISSUE CLAMPS	218	CRYER ROOT ELEVATOR SET OF 6	93
CHEEK RETRACTOR	203-204	CRYER ROOT ELEVATORS	78, 83, 84
CHEEK RETRACTOR COMBINATION	203	CRYER ROOT ELEVATORS SET OF 2 PCS	94
CHEEK RETRACTOR EASY TO BEND	203	CURETTES	158-167, 170, 173, 181-182, 303
CHEEK RETRACTOR LONG	204	CUSHING TAYLOR TWEEZERS	108
CHEEK RETRACTOR RETRACTOR IVORY	202	CUSHING TWEEZERS	111
CHIP BLOWER	233	CUTTER	262
CHISELES, BONE FILES & SPOONE CURETTE	235-236	CUTTER, UTILITY PLIERS & WIRE FORMING PLIERS	263
CHISELS	145, 147	CUTTERS	262
CHOMPRET ROOT ELEVATOR	92	D	
CHOMPRET ROOT ELEVATORS SET OF 3 PCS	94	D COSMETIC CONTOURING	284
CINCH BACK / TIE BACK DISTAL END BENDING PLIERS T.C	268	DE BACKY ATRAUMATIC TWEEZERS	107
CLAMP, OSTEO METER	278	DE LA ROSA PLIER	256

DESCRIPTION	PAGE#
DEAN DISSECTING SCISSORS, S/S	215
DEAN GUM SCISSORS	208
DEAN SCISSORS TC	213
DEBAKEY ATRAUMATIC TISSUE FORCEPS	304
DE-BAKEY WITH TUNGSTEN CARBIDE TWEEZERS	108
DEEP GRIPE EXTRACTING FORCEPS	34
DEEP GRIPPING ROOT FORCEPS	32-33
DEEP ROOT PICK FORCEPS	35-37
DELUX BOLEY GAUGE	279
DELUXE BRACKET HOLDER	250
DELUXE BRACKET HOLDER TWEEZERS	250
DENHARD RETRACTORS - MOUTH GAGS	201
DENTAL BUR CLEANING BRUSH COPPER	309
DENTAL FLASK 4 PARTS, BRASS	193
DENTAL FLASK, 4 PARTS SILVER	193
DENTAL MIRROR MAGNIFY NO.5 WITH HANDLE	155
DENTAL PHOTOGRAPHIC MIRRORS	197
DENTAL SCISSORS	211
DENTAL SINGLE FLASK, BRASS	193
DENTAL SYRINGES	240-243
DENTAL SYRINGES WITH SILICON HANDLE	240
DENTAURUM RULER	280
DENTINS REMOVALS	149
DENTURE FLASK LOWER, BRASS	192
DENTURE FLASK UPPER, BRASS	192
DEPTH & GINGIVAL GAUGES	276
DERF NEEDLE HOLDERS	219, 222
DETAILING STEP PLIERS / BAYONET BENDING PLIERS T.C	268
DIDNER 8 P MATRIX RETAINERS	231-232
DIEFFENBACH SCALPEL KNIVES	199-200
DIRECT BOND BRACKET HOLDER TWEEZERS	250
DIRECT BONDING BRACKET HOLDERS	250
DIRECT BRACKET REMOVER TC. GOLD.	272
DISC SYSTEM DENTAL SYRINGES	242
DISTAL BENDER SILICON GRIP	253
DISTAL ENAMEL INSTRUMENTS	146
DISTAL END CUTTER	262
DISTAL END CUTTER LONG HANDLE TC. GOLD.	271
DISTAL END CUTTER T.C	266
DISTAL END CUTTER TC. GOLD.	271
DISTAL END CUTTER, SAFETY HOLD PLIER T.C	271
DISTAL ROOT ELEVATOR	80, 102
DOUBLE ENDED OSTEOTOMY DEPTH GAUGE	276
DOUBLE ROUNDED JAW BENDING PLIERS	269
DOUBLE-ENDED EXPLORERS	117
DR. ALLEN END-CUTTING INTRASULCULAR KNIFE	176
DRESSING JAR / COTTON CONTAINER SPUTUM CUP	336
DRESSING JAR WITH LID & KNOB	336
DYERLINE FLASK, SILVER	193
DYNAMOMETER	280
E	
E COSMETIC CONTOURING	284
EASY ACCESS TWEEZERS	250
ELASTIC INSTRUMENT SILICON GRIP	253
ELASTIC INSTRUMENTS	251
ELASTIC SEPARATING & LIGATURE PLIER	224
ELASTIC SEPARATING PLIER	273
ELASTOMERIC LIGATURE PLACING FORCEPS WITH GROOVE	273
ELASTOMERIC SEPARATOR	261
ELLIOT MATRIX RETAINERS	232
ENAMEL INSTRUMENTS	146
ENDED CHEEK RETRACTORS	201
ENDO FINGER RULER SPAN MEASURE SCALE	249

DESCRIPTION	PAGE#
ENDODONTIC BOX	337
ENDODONTIC EXCAVATORS	149
ENDODONTICS INSTRUMENTS	126
ENDODONTICS INSTRUMENTS	127
ENDO-LOCKING GROOVED TWEEZERS	106
ENGLISH PATTERN SOLID TYPE	324
ERMERT WAX KNIVES	190
EURO BREECH LOADING DENTAL SYRINGES	240
EWALD / HUDSON TWEEZERS	110
EXAMINATION SETS	114-115
EXCAVATORS	121, 149-151, 153, 155
EXCAVATORS INSTRUMENTS	138
EXECT BRACKET HOLDER TWEEZERS	250
EXPLORERS	116-117, 119-120, 123-124
EXPLORERS INSTRUMENTS	117, 119, 124
EXTRA LARGE CASSETTE FOR 6 INSTRUMENTS	340
EXTRACTING FORCEPS (AMERICAN PATTERN HOLE HDL)	64-65
EXTRACTING FORCEPS (AMERICAN PATTERN)	38-66
EXTRACTING FORCEPS (ANATOMICAL HANDLE)	55-63
EXTRACTING FORCEPS (ANATOMICAL HANDLE) 10 PCS	69
EXTRACTING FORCEPS (ENGLISH PATTERN HOLE HANDLE)	34-37
EXTRACTING FORCEPS (ENGLISH PATTERN)	01-37, 66
EXTRACTING FORCEPS (ENGLISH PATTERN) 10 PCS	69-70
EXTRACTING FORCEPS (ENGLISH PATTERN) SET OF 13 PCS	70
EXTRACTING FORCEPS (FOR CHILDREN)	26-27, 30-31
EXTRACTING FORCEPS (HOLE PATTERN HANDLE) 10 PCS	69
EXTRACTING FORCEPS ANATOMICAL HANDLE (BLACK COATED) 10 PCS	67
EXTRACTING FORCEPS ANATOMICAL HANDLE (TITANIUM COATED) 10 PCS	67
EXTRACTING FORCEPS ANATOMICAL HANDLE 10 PCS	67
EXTRACTING FORCEPS ENGLISH PATTERN (BLACK COATED) 10 PCS	68
EXTRACTING FORCEPS ENGLISH PATTERN (TITANIUM COATED) 10 PCS	68
EXTRACTING FORCEPS ENGLISH PATTERN 10 PCS	68
EXTRACTING FORCEPS KITS	71
EXTRACTING FORCEPS KITS GOLD COATED 25 PCS	71
EXTRACTING FORCEPS KITS POLISH 25 PCS	71
EXTRACTING FORCEPS SET	67-70
EXTRA-FLEX IMPLANTOLOGY	281, 285
F	
F COSMETIC CONTOURING	284
FAHNENSTOCK WAX KNIVES	188
FALCON BEAK CONTOURING PLIERS	255, 269
FARABEUF RETRACTORS SET OF 2 PCS	205
FEDI PERIODONTAL CHISELS	178
FELDMAN RETRACTOR	205
FELSCH EXTRACTING FORCEPS (ENGLISH PATTERN)	19
FILLING INSTRUMENTS	121, 128-136, 143-148, 153, 166, 183-184
FINE SUCTION TUBE	313
FIRST AID EXAMINATION KIT SET OF 3 PIECES	114-115
FIRST AID EXAMINATION SET OF 4 PIECES	114-115
FLAGG TWEEZERS	106
FLASKS & COMPRESSORS	192-193
FLAT NOSE PLIERS	255, 260
FLEXI-THIN IMPLANTOLOGY	281
FLOHR ROOT ELEVATORS	76, 83-84
FLOHR ROOT ELEVATORS SET OF 2 PCS	94
FLUCH-CUT DISTAL AND CUTTING PLIERS T.C	258
FLUSH-CUT DISTAL END CUTTER T.C	266
FOERSTER DRESSING FORCEPS	217
FOR SPECIAL PACKING OF ORTHODONTIC PLIERS	265

DESCRIPTION	PAGE#
FORCEPS FOR PLACING DENTALASTICS	274
FORCEPS JARS	336
FRAHM CARVERS INSTRUMENTS	144
FRAZIER SUCTION TUBES	314
FREEDMAN "DUCKHEAD" BURNISHERS	283
FREEDMAN BURNISHERS	283
FREER PERIODONTAL INSTRUMENTS	239
FREER SPOONE CIREETE	235
FRET SAW	248
FRIEDMAN BONE ROUNGER	245
FRIEDMANN ROOTS ELEVATOR	79
FRONT SURFACE MOUTH MIRRORS	104
FURRER COPPER RING REMOVING PLIER	247

G

GARTNER ROOT ELEVATOR	85
GERALD DRESSING FORCEPS	85
GERALD TWEEZERS	107
GILLES TWEEZERS	107
GILLIES NEEDLE HOLDER WITH SCISSORS	220, 223
GINGIVAL RETRACTORS	141
GLICK BLADE/ PLUGGER	127
GLOVES BOX	335
GOLDMAN FOX POINTED PROBES	120
GOLDMAN FOX EXPLORERS	119
GOLDMAN FOX PERIODONTAL INSTRUMENTS	140
GOLDMAN FOX POINTED PROBES	120
GOLDMAN FOX SCISSORS	214
GOLDMAN FOX UNIVERSITY OF MICHIGAN POINTED PROBES	120
GOLDMAN FOX WILLIAMS POINTED PROBES	120
GOLDMAN PERIODONTAL INSTRUMENTS	168, 171
GOLDMAN-FOX PERIODONTAL INSTRUMENTS	239
GOLDMAN-FOX GUM SCISSORS	207, 212
GOLDMAN-FOX PERIODONTAL KNIVES	177
GOSLEE FLAT NOSE PLIERS	260
GRACEY AFTER FIVE	167
GRACEY CURETTE	160-161
GRACEY CURETTE SET OF 7 PCS	161
GRACEY CURETTE SET OF 7 PCS WITH SILICON HANDLE	161
GRACEY CURETTES	159, 162-163, 167
GRACEY CURETTES SET OF 7 PCS	162-163
GRACEY CURETTES SET OF 7 PCS WITH SILICON GRIP	164
GRACEY CURETTES SOLID HANDLE	158
GRACEY MINI FIVE	167
GRACEY PERIODONTAL INSTRUMENTS	140
GRADED HANDLE HYLIN CARVER	187
GRAFT MATERIAL SPOON	296
GRAFT PACKER	296
GRAFT PACKER, CONCAVE	296
GREGG IMPLANTOLOGY	282
GRIPPER CARBIDE TIPPED TISSUE FORCEPS	304
GRITMAN WAX AND MODELLING CARVERS	186
GROOVED FINE PLIER	258
GROSS MAIER DRESSING FORCEPS	217
GUM SCISSORS	206-215

H

HAEMOSTATIC FORCEPS & TOWEL CLAMPS	217
HAEMOSTATIC FORCEPS	216
HALSEY NEEDLE HOLDERS	219, 222
HALSTEAD MOSQUITO HAEMOSTATIC FORCEPS	216
HAMMER HEAD DISTAL END BENDING PLIERS	268
HAMMER WITH WOODEN HANDLE	248
HANDLES FOR MOUTH MIRRORS	105
HARD WIRE CUTTER	262

DESCRIPTION	PAGE#
HARD WIRE CUTTER T.C	266
HARRIS EXTRACTING FORCEPS (AMERICAN PATTERN)	43
HARTMANN (BABY MOSQUITO) HAEMOSTATIC FORCEPS	216
HATCHES	146
HEAT CARRIERS	125
HEBER ROOTS ELEVATOR	86
HEIDBRINK ROOT APPEX ELEVATOR	91
HEIDBRINK ROOT ELEVATORS	79, 90-91
HEIDBRINK ROOT TIP PICKS	90
HEIDEMANN PLASTIC FILLING INSTRUMENTS	135-136
HEIDEMANN SPATULA	137, 148
HEIGHT GAUGE STAINLESS STEEL	249
HEISS HAEMOSTATIC FORCEPS	216
HEMINGWAY BONE CURETTES	181
HEMINGWAY TWEEZERS	109
HENAHAN EXTRACTING FORCEPS (AMERICAN PATTERN)	52
HERBERT PERIODONTAL INSTRUMENTS	237
HERTZ EXTRACTING FORCEPS (ENGLISH PATTERN)	20
HEX DRIVER WITH	310
HEX TORQUE WRENCH	310
HIRSCHFELD FILE	156
HIRSCHFELD PERIODONTAL FILES	157
HMG HEISTER CHEEK RETRACTOR	202
HOLLENBACK CARVERS INSTRUMENTS	143
HOLLENBACK FILLING INSTRUMENTS	128
HOLLENBACK IMPLANTOLOGY	285
HOLLOW CHOP CONTOURING PLIERS	264
HOLLOW WARE INSTRUMENTS	334-341
HOOK CRIMPING PLIER ANGLED TC. GOLD.	271
HOOK KNIVES	190
HOW ANGLED UTILITY PLIERS T.C	267
HOW PLIER	255, 263
HOW PLIERS OFFSET	263
HOW STRAIGHT UTILITY PLIERS T.C	267
HOWARD BONE FILE	179
HOWARD PERIODONTAL INSTRUMENTS	238
HULL EXTRACTING FORCEPS (AMERICAN PATTERN)	48
HYGIENIST JACQUETTE PERIODONTAL INSTRUMENTS	169, 172
HYGIENIST PERIODONTAL INSTRUMENTS	168, 171
HYGIENIST-JACQUETTE PERIODONTAL INSTRUMENTS	168, 171
HYGIENIST-TOWNER PERIODONTAL INSTRUMENTS	168, 171
HYLIN CARVERS INSTRUMENTS	187
HYLIN ROOTS ELEVATOR	82
HYLIN-CERAMICA CARVERS INSTRUMENTS	187
HYLIN-LE CRON CARVERS INSTRUMENTS	187

I

IMPLANT	294
IMPLANT DEPTH GAUGE & KEY	276
IMPLANT DEPTH GAUGE	276
IMPLANTOLOGY	276-314
IMPRESSION TRAYS PERFORATED RIM LOCK UPPER	315
IMPRESSION TRAYS SET OF 10 PCS	331
IMPRESSION TRAYS SOLID RIM LOCK UPPER	315
IMPRESSION TRAYS	315-333
IMPRESSION TRAYS ENGLISH PATTERN	323
IMPRESSION TRAYS MESH TYPE	323
IMPRESSION TRAYS ORTHODONTIAL PERFORATED	326
IMPRESSION TRAYS ORTHODONTIAL SOLID	326
IMPRESSION TRAYS PARTIAL PERFORATED	329
IMPRESSION TRAYS PARTIAL SOLID	329
IMPRESSION TRAYS PERFORATED FULL DENTURE	325
IMPRESSION TRAYS PERFORATED LOWER	318
IMPRESSION TRAYS PERFORATED RIM LOCK	316

DESCRIPTION	PAGE#
IMPRESSION TRAYS PERFORATED SET OF 06 PCS	319
IMPRESSION TRAYS PERFORATED SET OF 08 PCS	319
IMPRESSION TRAYS PERFORATED SET OF 10 PCS	319
IMPRESSION TRAYS PERFORATED UPPER	318
IMPRESSION TRAYS PERFORATED WITHOUT RIM LOCK	327
IMPRESSION TRAYS PUNCHED TYPE	323
IMPRESSION TRAYS SET OF 06 PCS	317, 320-328, 332-333
IMPRESSION TRAYS SET OF 08 PCS	317, 320-321, 323-328
IMPRESSION TRAYS SET OF 10 PCS	320, 327-328
IMPRESSION TRAYS SET OF 12 PCS	327-328
IMPRESSION TRAYS SET OF 5 PCS	329
IMPRESSION TRAYS SET OF 7 PCS	329
IMPRESSION TRAYS SOLID FULL DENTURE	325
IMPRESSION TRAYS SOLID LOWER	318
IMPRESSION TRAYS SOLID RIM LOCK	316
IMPRESSION TRAYS SOLID SET OF 06 PCS	319
IMPRESSION TRAYS SOLID SET OF 08 PCS	319
IMPRESSION TRAYS SOLID SET OF 10 PCS	319
IMPRESSION TRAYS SOLID UPPER	318
IMPRESSION TRAYS SOLID WITHOUT RIM LOCK	328
INSTRUMENTS BOX	335
INSTRUMENTS BOX PERFORATED	335
INSTRUMENTS BOX WITH HOOKS	335
INSTRUMENTS BOX WITH LID	335
INSTRUMENTS CASSETTE 10 PIECES CASSETTE	340
INSTRUMENTS CASSETTE 15 PCS	340
INSTRUMENTS CASSETTE 20 PCS	340
INSTRUMENTS CASSETTE	340
INSTRUMENTS CASSETTE 5 PIECES CASSETTE	340
INSTRUMENTS CASSETTE 7 PIECES CASSETTE	340
INSTRUMENTS CASSETTE DETACHABLE 20	340
INSTRUMENTS CASSETTE HINGED 10 PCS	340
INSTRUMENTS CASSETTE HINGED 20 PCS	340
INSTRUMENTS CASSETTE HINGED 7 PCS	340
INSTRUMENTS MANAGEMENT SYSTEM	340
INSTRUMENTS TRAY PERFORATED	334, 340
INSTRUMENTS TRAY PERFORATED BASE	340
INSTRUMENTS TRAY SOLID BASE	340
INSTRUMENTS TRAYS	334
INSTRUMENTS TRAYS WITH COVER	335
INSTRUMENTS TRAYS WITH LID	334
INSTRUMENTS TRAYS WITHOUT COVER	335
INTERPROXIMAL CARVER	282
INTERPROXIMAL CARVER, LONG	282
INTERPROXIMAL CARVERS INSTRUMENTS	144
INTERPROXIMAL OFF-ANGLE	144
INTRALIGAMENTAL ANESTHESIA SYRINGE	242
INTRALIGAMENTARY SYRINGE	241
IRIS GUM SCISSORS	206, 212
IRIS SCISSORS	214
IRONING CRESCENT	155
IVORY RUBBER DAM CLAMPS FORCEPS	224
IVORY 8 MATRIX RETAINERS	231
IVORY 8 N MATRIX RETAINERS	231
IVORY MATRIX RETAINERS	232
IVORY RUBBER DAM CLAMPS FORCEPS	224
IWANSON SPRING CALIPER	278

J

JACQUETTE PERIODONTAL INSTRUMENTS	169, 172
JACQUETTE SCALERS	169, 172
JAQUETTE PERIODONTAL INSTRUMENTS	140
JARABAK PILERS	259, 264
JECT ANGLED DENTAL SYRINGES	242

DESCRIPTION	PAGE#
JECT STRAIGHT DENTAL SYRINGES	242
JECT ULTIMA INJECTS	242
JOHNSON CONTOURING PLIERS	255
JOHNSON PLIERS FOR CROWN BAND CONTOURING	269
JONES HAEMOSTATIC FORCEPS	217
JOSEPH GUM SCISSORS	207-208

K

KALT NEEDLE HOLDERS T.C	221
KELLS EXTRACTING FORCEPS (AMERICAN PATTERN)	48
KELLY GUM SCISSORS	208, 213
KELLY HAEMOSTATIC FORCEPS	216
KELLY-RANKIN HAEMOSTATIC FORCEPS	216
KERRISON BONE ROUNGER	244
KEY RINGS	230
KEYS FOR IMPLANT SCREW	310
KIDNEY TRAY	336
KIDNEY TRAY SHALLOW	336
KIDNEY TRAY WITH COVER	336
KILNER (RAGNELL) GUM SCISSORS	207
KIRKLAND PERIODONTAL KNIVES	177
KIRKLAND PERIODONTAL INSTRUMENTS	140
KLEIN PEDIATRIC TOOTH EXTRACTING FORCEPS	26
KOCHER RETRACTORS	205
KOEHLER LUXATION FORCEPS	30
KOPP ROOTS ELEVATOR	85-86
KRAMER NEVINS SINUS LIFT	293
KRAMER-NEVINS PERIODONTAL CHISELS	180
KRARNER-NEVINS BONE CHISEL	235

L

LA GRANGE NEEDLE HOLDERS	221
LA GRANGE GUM SCISSORS	207, 212
LADMORE BURNISHERS	
LADMORE FILLING INSTRUMENTS	132
LAGRANGE SCISSORS	214
LANGENBECK RETRACTORS	205
LAP & L-KEY JOINT PLIERS	271
LARGE FLUCH-CUT DISTAL AND CUTTING PLIERS T.C	258
LAXUTOR ROOT ELEVATORS	77
LE CRON CARVERS INSTRUMENTS	187
LE CRON WAX AND MODELLING CARVERS	186
LECLUSE ROOTS ELEVATOR	89
LEMPERT DELICATE BONE ROUNGER	245
LESSMANN WAX KNIVES	188
LICHTENBERG-RYDER T.C NEEDLE HOLDERS	221
LIGATURE CUTTERS T.C	257
LIGATURE INSTRUMENT SILICON GRIP	253
LIGATURE INSTRUMENTS	251
LIGATURE PLIERS T.C GOLD	274
LIGHT WORE BIRD BEAK PLIERS WITH GROOVE	264
LINDO LEVIAN ROOT ELEVATORS	79
LINGUAL / PALATAL ARCH FORMING PLIES	268
LINGUAL ARCH FORMING PLIERS	264
LINGUAL DENTAL PHOTOGRAPHIC MIRRORS	197
LINGUAL-LARGE DENTAL PHOTOGRAPHIC MIRRORS	197
LISTER BANDAGE SCISSORS	211
LISTON BONE ROUNGER	246
L-KEY JOINT PLIERS	269, 272
L-KEY JOINT PLIERS T.C	266, 268
L-KEY JOINT PLIERS WITHOUT T.C	268
LOCKLIN DISSECTING SCISSORS, S/S	215
LOCKLIN GUM SCISSORS	208
LONDON COLLEGE TWEEZERS	106, 108
LONDON HOSPITAL COLEMAN	82

DESCRIPTION	PAGE#
LONG IMPLANT DRILLS SET OF 4 PCS	308
LORNA STERILIZING & TISSUE CLAMPS	218
LUCAS CURETTES	140, 166, 182, 303
LUCAS SPOON SHAPE	182
LUCAS SURGICAL CURETTE	182
LUER BONE ROUNGER	244
LUXATING ELEVATOR	87-88
LUXATING ELEVATOR / PERIOTOME	88
LUXATING ELEVATORS SET OF 08 PCS - BLUE TITANIUM COATED TIPS	98
LUXATING ELEVATORS SET OF 10 PCS - BLUE TITANIUM COATED TIPS	97
LUXATING ELEVATORS SET OF 10 PCS - GOLD COATED TIPS	98
LUXATING ELEVATORS SET OF 10 PCS	95
LUXA-TOOL ROOT ELEVATOR	101
LUXATOR ROOT ELEVATOR	74
LUXATORS (MULTI HANDLE) SET OF 10 PCS	96
LUXATORS (WHITE HANDLE) SET OF 10 PCS	95
LUXIER ROOTS ELEVATOR	81
LUXIVATORS ROOT ELEVATOR	102
M	
MADE OF BRASS	320
MAGNIFYING MOUTH MIRRORS	103
MALLETS - PLASTER SHEARS - SAWS & BLADES	248
MANUAL ASPIRATING SYRINGE	240
MARGINAL RIDGE & EMBRASURE SHAPING INSTRUMENT	284
MARKLEY FILLING INSTRUMENTS	128, 135-136
MARQUETTE FILLING INSTRUMENTS	128
MARTIN BONE CURETTES	181
MATHIEU LIGATURE PLIERS	274
MATHIEU NEEDLE HOLDERS	220, 223
MATHIEU PLIERS	274
MATHIEU-KOCHER NEEDLE HOLDERS	220, 223
MATRIX IVORY 8 MATRIX RETAINERS	232
MATRIX RETAINERS	231, 232
MAXI INSTRUMENTS TRAY	338
MAYO DISSECTING SCISSORS	215
MAYO GUM SCISSORS	209, 212
MAYO TRAY PERFORATED	334
MAYO-HEGAR NEEDLE HOLDERS	219, 222
MCCALL PERIODONTAL INSTRUMENTS SET	122
MCCALLS PERIODONTAL INSTRUMENTS	122
MEAD PERIODONTAL INSTRUMENTS	237
MEAD EXTRACTING FORCEPS (ENGLISH PATTERN)	19
MEASURING LOOP	278
MEASURING PROBE	276
MEAT PERIODONTAL INSTRUMENTS	239
MEDAN ROOTS ELEVATOR	83
MEISSNER EXTRACTING FORCEPS	66
MEMBRANE 3 POSITIONING IMPLANTOLOGY	289
MEMBRANE FORCEP	304
MEMBRANE TWEEZERS KUEHNE	305
MERCURY CARVERS INSTRUMENTS	144
MERIAM TWEEZERS	106-108
MERRIT A POINTED PROBES	120
MERRIT B POINTED PROBES	120
MERSHON BAND PUSHER	253
MESH CASSETTES 5 PCS, 7 PCS, 10 PCS, 15PCS & 20 PCS	341
MESH TRAYS 05 PCS	341
MESH TRAYS 07 PCS	341
MESH TRAYS 10 PCS	341
MESH TRAYS 20 PCS	341
MESH TRAYS	341

DESCRIPTION	PAGE#
MESIAL & DISTAL ROOT ELEVATORS	80
MESIAL ENAMEL INSTRUMENTS	146
MESIAL ROOT ELEVATOR	102
METHIEU PLIER WITH RING LIGATURE PLIERS	274
METHOT JAR WITHOUT LID	336
METZENBAUM GUM SCISSORS	206, 213
METZENBAUM STANDARD SCISSORS	215
MICOR ADSON TISSUE FORCEP	304
MICRO BOLEY GAUGE	280
MICRO BOLEY GAUGE TWISTED	280
MICRO FRIEDMAN 90° BONE ROUNGER	245
MICRO FRIEDMAN BONE ROUNGER	245
MICRO IRIS GUM SCISSORS	206
MICRO LUER BONE ROUNGER	244
MICRO MASQUITO 1X2 STERILIZING & TISSUE CLAMPS	218
MICRO MASQUITO STERILIZING & TISSUE CLAMPS	218
MICRO SURGERY INSTRUMENT	112
MICRO-ADSON TWEEZERS	111
MICRO-CUSHING TWEEZERS	111
MICRO-MINI IMPLANTOLOGY	281, 285
MICRO-MINI PIN & LIGATURE CUTTER	262
MIDDELDORPF RETRACTOR	205
MIDI INSTRUMENTS TRAY	338
MILLER ROOT ELEVATORS	78
MILLER BONE FILE	179, 235
MILLER CHISELE	235
MILLER CURETTES	303
MILLER TWEEZERS & SPLINTER FORCEPS	113
MINI IMPLANTOLOGY	281
MINI 3 EXTRA-FLEX IMPLANTOLOGY	281
MINI IMPLANTOLOGY	285
MINI LIGATURE CUTTERS T.C	257-258
MINI PIN & LIGATURE CUTTER	262
MINI PIN & LIGATURE CUTTER TC.GOLD	271
MINI RETRACTOR	204
MINI-LANGENBECK RETRACTOR	204
MINNESOTA LARGE RETRACTORS	203
MINNESOTA SMALL RETRACTORS	203
MIRROR WITH ELECTRIC BATTERY	197
MISCELLANEOUS PRODUCTS	230
MISCH SOCKET SCOOP	73
MIXING SPATULA WITH SHOVEL	295
MODELLING INSTRUMENTS	154
MODIED MCCALL SCALER	170, 173
MODIFIED TG-0 PERIODONTAL CHISELS	180
MOLARS ROOTS ELEVATOR	82
MOLT PERIODONTAL INSTRUMENTS	239
MOUTH GAG MOLT (ADULTS)	202
MOUTH GAG MOLT (CHILDREN)	202
MOUTH MIRRORS	103-104, 121
MOUTH PROPS LARGE	230
MOUTH PROPS MEDIUM	230
MOUTH PROPS SMALL	230
MOVEABLE HEIGHT GAUGE	249
MULTIFUNCTIONAL METER	276
MULTI-PURPOSE PLIERS, BIRD BEAK, CUTTER	268
N	
NABERS PROBE	118
NANCE LOOP FORMING PLIERS	256, 268
NANCE PLIER TC. GOLD	272
NANCE PLIERS	256
NAPKIN HOLDER WITH METAL CHAIN	230
NEEDLE HOLDERS	219-223

DESCRIPTION	PAGE#
NEEDLE STERILIZATION TUB	337
NERVE-CANAL PLIERS	247
NEUMANN GUM SCISSORS	207
NEVIUS EXTRACTING FORCEPS (AMERICAN PATTERN)	47, 52
NOYES GUM SCISSORS	210
NYSTROM	145
NYSTRÖM MATRIX RETAINERS	232
O	
OCCLUSAL ANATOMY INSTRUMENT	284
OCG IMPRESSION TRAYS	330
OCHSENBEIN PERIODONTAL CHISELS	178
OCHSENBIN PERIODONTAL INSTRUMENTS	237
OCP IMPRESSION TRAYS	330
OHL PERIODONTAL INSTRUMENTS	238
OLSEN-HEGAR NEEDLE HOLDER WITH SCISSORS	220, 223
OMEGA LOOP FORMING PLIERS	263
ORBAN PERIODONTAL KNIVES	177
ORBAN KNIFE	140, 177
ORINGER MEDIUM RETRACTORS	203
ORTHO BAND PUSHER SCALER	252
ORTHO INSTRUMENT	251
ORTHO LIGATURE DIRECTOR SINGLE ENDED	252
ORTHO LIGHT BAND PUSHER SCALER	253
ORTHO LIGHT DOUBLE ENDED LIGATURE	252
ORTHO LIGHT DOUBLE ENDED LIGATURE DIRECTOR	252
ORTHO LIGHT DOUBLE ENDED LIGATURE DIRECTOR SCALER	253
ORTHO LIGHT DOUBLE ENDED LIGATURE SCALER	252
ORTHO LIGHT LIGATURE DIRECTOR DOUBLE ENDED	252
ORTHO LIGHT SCALER	251
ORTHO PLIERS	270
ORTHO RULER / CONE SOCKET	280
ORTHODONTIC INSTRUMENTS	249-253
ORTHODONTICS PLIERS STANDS	275
ORTHOLITE LIGATURE DIRECTOR SCALER	252
OSTEOMETER MEASURING FORCEPS	249
OSTEOTOME CONCAVE SET OF 5 PIECES	307
OSTEOTOME CONIQUES SET OF 5 PIECES	307
OSTEOTOME CONVEXES / CONCAVE / CONIQUES	306-307
OSTEOTOME CONVEXES SET OF 5 PIECES	307
OSTEOTOME SET OF 5 PIECES	306
OSTEOTOMY DEPTH GAUGE	276
OVAL SHAPE	150
OVAL SPOON EXCAVATORS	149
P	
P.K. THOMAS WAX CARVERS SET OF 5 PCS	183
P.K. THOMAS SET OF 5 PCS WITH STERILIZED CASSETTE	183
P.K. THOMAS WAXING INSTRUMENTS	183
PALATAL-ADULT DENTAL PHOTOGRAPHIC MIRRORS	197
PALATAL-ADULT LARGE DENTAL PHOTOGRAPHIC MIRRORS	197
PALATAL-CHILD DENTAL PHOTOGRAPHIC MIRRORS	197
PALMER RUBBER DAM CLAMPS FORCEPS	224
PARMLY EXTRACTING FORCEPS (AMERICAN PATTERN)	45
PARTIAL OCCLUSAL STAINLESS STEEL IMPRESSION TRAYS	330
PARTSON PERIODONTAL INSTRUMENTS	237
PDL ELEVATORS	102
PDL ELEVATORS SET OF 10 PCS	101
PDL ELEVATORS SET OF 7 PCS	102
PDL ELEVATORS SET OF 8 PCS	102
PEDIATRIC TOOTH EXTRACTING FORCEPS	26
PEESO WIRE BENDING PLIERS	260
PEET PLIERS	113
PEET SPLINTER FORCEPS	221
PERFORATED FULL DENTURE UPPER	317, 321

DESCRIPTION	PAGE#
PERIODONTAL CHISELS	178, 180, 236
PERIODONTAL FILES	156-157
PERIODONTAL INSTRUMENTS 121-122, 137-142, 153-157, 168-173, 176-177, 178, 180, 237-239	
PERIODONTAL INSTRUMENTS SET	155
PERIODONTAL KNIVES	176-177
PERIODONTAL PROBES	125-127
PERIODONTAL SET OF 10 PIECES	121
PERIOSTEEL ELEVATORS	238, 300-302
PERIOTOME GOLD TIP	99
PERIOTOME LUXATING ELEVATORS SET OF 04 PCS - GOLD COATED TIPS	99
PERIOTOME ROOTS ELEVATOR	90
PERRY TWEEZERS	106, 108
PHYSICK EXTRACTING FORCEPS (AMERICAN PATTERN)	41
PIN & LIGATURE CUTTER	262
PIN & LIGATURE CUTTERS TC. GOLD.	271
PIN HOLDING PLIER	272
PIN-TWEEZERS	305
PISTOL-JECT INJECTS	242
PLAIN MOUTH MIRRORS	103
PLASMA COATED HANDLE	123
PLASTER KNIFE	189
PLASTER KNIVES	189
PLASTER SHEARS	248
PLASTIC FILLING INSTRUMENTS	133-136
PLIER STAND PLASTIC	275
PLIER STAND STAINLESS STEEL.	275
PLIERS FOR ORTHODONTICS & PROSTHETICS	254-274
PLIERS TO PLACE MODULES	274
PLUGGER	155, 298
POINTED CURETTE	170, 173
POINTED PROBES	120
POINTED PROBES POINTED PROBES	120
POLOKOFF BONE FILE	179
POSIGRIP ARTICULATING PAPER FORCEPS	113
POSITIVE POSTIONER	249
POSTERIOR BAND REMOVING PLIERS - LONG	263
POSTERIOR BAND REMOVING PLIERS - SHORT	263
POSTERIOR JACQUETTE PERIODONTAL INSTRUMENTS	169, 172
POSTERIOR SINGLE ENDED	127
POTT ROOTS ELEVATOR	89
POTTS "T-HANDLE" ELEVATOR-LEFT ROOT ELEVATOR	73
POTTS ROOT ELEVATOR	73
POTTS-SMITH DRESSING FORCEPS	108
POTTS-SMITH TISSUE FORCEPS 1X2 TEETH	108
PRICHARD PERIODONTAL INSTRUMENTS	238
PROBE	118, 152, 155
PROBES DOUBLE ENDED	119
PROJECTION SYSTEM DENTAL SYRINGES	242
PRONG 3 CLASP ADJUSTABLE PLIER TC. GOLD.	272
PROXIMATOR ROOT ELEVATOR	101
PUNCH BONE ROUNDER	246
Q	
QUATRO DENTAL SYRINGES	240
R	
RALK ROOTS SPLINTER FORCEPS	29
RAMUS RETRACTORS	205
RASP, MOLT	302
RASPATOR, BENQUE	302
RASPATOR, BONE SCRAPER	300
RASPATOR, FREER	300-301

DESCRIPTION	PAGE#
RASPATOR, MICRO FREER	301
RASPATOR, MICRO RASPATOR / CHISEL	301
RASPATOR, MICRO-FREER	300
RASPATOR, MOLT	301
RASPATOR, PAPILLA	300
RASPATOR, PRICHARD	295
RASPATOR, RASPATORY	238, 300
RASPATOR, WAUTIER	302
RASPATOR, WILLIGER	238
RASPATORY CHIPPING	302
RASPATORY MOLT	302
RECTANGULAR ARCH BENDING PLIERS	264
REDDY THIN PERIODONTAL KNIVES	176
REMINGTON HOE PERIODONTAL CHISELS	180
RETRACTOR	204
RETRACTOR AND TONGUE PUSHERS BISHOP WITH COMFORTABLE MARGIN	203
RETRACTOR WITH ERGO GRIP	202
RETRACTORS - MOUTH GAGS	201-202
RETRACTORS	203-205
RETRO FILLING INSTRUMENTS	127
RHODES BACK-ACTION PERIODONTAL CHISELS	180
RHODIUM MOUTH MIRRORS	104
RIDGE MAPPING DOUBLE CALIPER	277
RING-2 DENTAL SYRINGES	240
RING-3 DENTAL SYRINGES	240
ROACH WAX AND MODELLING CARVERS	186
ROCHESTER-KOCHER 1X2 HAEMOSTATIC FORCEPS	216
ROCHESTER-PEAN HAEMOSTATIC FORCEPS	216
ROGGE STERILIZING & TISSUE CLAMPS	218
ROMEROWSKI FILLING INSTRUMENTS	132
ROOT CANAL PLUGGER	124
ROOT CANAL SPREADER	165
ROOT ELEVATOR	72-79, 80-92, 94-102
ROOT ELEVATOR SET OF 6	93
ROOT ELEVATORS SET OF 3 PCS	94
ROOT ELEVATORS SET OF 6 PCS	92
ROOT PLANNING CHISELS & BONE FILES	235
ROOTS ELEVATOR	81, 83
ROOTS SPLINTER FORCEPS	29
ROSER-KONIG RETRACTORS - MOUTH GAGS	201
ROUND BOWLS	336
ROUND BOWLS WITH COVER	339
ROUND BOWLS WITH OUT COVER	339
ROUND DENTAL FLASK, BRASS	192
ROUND DENTAL FLASK, SILVER	193
ROUND ENDODONTIC BOXES	337
ROUND STERILIZER DRUM	339
ROUND STERILIZER DRUMS "FILTER"	339
ROUND TORQUE WRENCH	310
ROUTURIER WISDOM EXTRACTING FORCEPS	23
RUBBER DAM CLAMPS	227
RUBBER DAM CLAMPS FORCEPS	224
RUBBER DAM CLAMPS KITS	225
RUBBER DAM FRAME LARGE	224
RUBBER DAM FRAME MEDIUM	224
RUBBER DAM FRAME SMALL	224
RUBBER DAM KITS	225
RUBBER DUM TEMPLATE	225
RULER	280
RULER WADGE	280
RUSKIN BONE ROUNGER	246
RUSSIAN LONG TISSUE FORCEPS	305
RUSSIAN TISSUE FORCEPS	305

DESCRIPTION	PAGE#
S	
SACHS WAX KNIVES	190
SANDERS PERIODONTAL KNIVES	176
SCALERS	170,173-174
SCALER CURETTE	170, 173
SCALERS TRAYS	334
SCALPEL BLADE & SCALPEL KNIVES	199
SCALPEL HANDLES	198
SCALPEL KNIVES	199-200
SCHLEMMER ROOTS ELEVATOR	82
SCHLUGER CURVED FILE	156-157
SCHMECKEBIER APEXO ROOT ELEVATOR	73, 76
SCHMECKEBIER ROOT ELEVATOR SET OF 6	93
SCHURE BAND SEATER	251
SCHWARZ	260
SELDIN PERIODONTAL INSTRUMENTS	238
SELDIN RETRACTOR	205
SELDIN ROOT ELEVATOR	74-75, 83
SELDIN ROOT ELEVATOR SET OF 6	93
SELF LOCKING GROOVED	304
SELF-LOCKING TWEEZERS	106
SEMKEN TAYLOR TWEEZERS	106
SENN MILLER RETRACTOR	204
SEPARATING FORCEPS	41
SEPARATING PLIERS FOR SEPARATORS	273
SHORT IMPLANT DRILLS SET OF 3 PCS	308
SICKLE SCALERS	171
SICKLE SCALERS INSTRUMENTS	168, 171
SILICONE HANDLES	165
SILVER INSTRUMENTS TRAY	338
SINGLE ENDED PROBE HOLLOW HANDLE ANATOMIC HANDLE	116
SINGLE ENDED PROBE SOLID HANDLE SOLID HANDLE	116
SINUS LIFT ELEVATOR	286-288
SINUS LIFT ELEVATORSET OF 6 PCS	292
SINUS LIFT INSTRUMENT	290-292
SINUS LIFT INSTRUMENTS BLUE PLASMA COATING	141
SINUS WINDOW BONE TAMPERS	298
SINUSLIFT IMPLANTOLOGY	289
SLIM WEINGART PLIERS	263
SLIPPER TWEEZERS	250
SMAHA ELASTOMERIC LIGATURE PLACING FORCEPS	273
SMALL FLASK WITH COMPRESSOR, BRASS	192
SOFT WIRE AND LIGATURE CUTTER T.C	266
SOLDERING PLIERS	113
SOLDERING PLIERS - TWEEZERS & SPLINTER FORCEPS	113
SOLID FULL DENTURE	321
SOLID FULL DENTURE UPPER	317
SOLT PERIODONTAL CHISELS	180
SOLT PERIODONTAL KNIVES	176
SPATULAS	148
SPECIAL INOX	190
SPECIAL PATTERN OF IMPRESSION TRAYS	320
SPENCER GUM SCISSORS	208
SPIRIT LAMP	337
SPOON AND PUSHER (TRINOVO)	299
SPOON AND PUSHER	297
SPOON AND PUSHER WITH SAFETY STOP	299
SPOON EXCAVATORS ROUND SHAPE	151
SPOONEXCAVATORS	149
SPREADERS	125
STANDARD EXTRACTING FORCEPS (AMERICAN PATTERN)	52
STANDARD LIGATURE CUTTER TC. GOLD.	271
STANDARD OPERATING SCISSORS	209

DESCRIPTION	PAGE#
STAR TORQUE WRENCH	310
STERIL SCALPEL BLADES	199
STERILIZING & TISSUE CLAMPS	218
STERILIZING MESH TRAY	341
STERNBERG RETRACTORS	203
STIEGLITZ ROOTS SPLINTER FORCEPS	29
STIEGLITZ SPLINTER FORCEPS	29
STIKSA EXTRACTING FORCEPS (ENGLISH PATTERN)	20
STOCKES RUBBER DAM CLAMPS FORCEPS	224
STOLLEY IMPRESSION TRAYS	330
STOP PLIERS V-BEBD T.C	268
STRAIGHT DIRECT BOND BRACKET REMOVER T.C	272
STRIP SAW	249
SUCTION CANNULA KIT	314
SUCTION NEEDLE	314
SUCTION PIPE	314
SUCTION TUBES	314
SUGARMAN FILE	156-157
SUGARMAN FILE SET	156-157
SUPER CUT GOLDMAN FOX SCISSORS	214
SUPER CUT IRIS SCISSORS	214
SUPER CUT LAGRANGE SCISSORS	214
SURGICAL BALL HOOK CRIMPING PLIERS	268
SURGICAL BALL HOOK CRIMPING PLIERS T.C	268
SURGICAL CHISELS	294
SUTURE FORCEPS	304
SUTURE FORCEPS TWEEZERS	111
SUTURE PLIERS	304
SWEDISH TYPE DENTAL SYRINGES	242
SWING EXTRACTING FORCEPS (AMERICAN PATTERN)	51
SYNDESMOTOMES ROOT ELEVATOR	90, 92, 101
T	
TAMPER BONE	297
TAMPERS ORTHODONTIC INSTRUMENTS	252
TANNER FILLING INSTRUMENTS	128
TANNER IMPLANTOLOGY	285
TARTAR REMOVER INSTRUMENTS	175
TAYLOR TWEEZERS	107, 111
THERMO FORMING PLIERS	270
THICK GROOVED PLIER	261
THREE JAW PLIERS	264
TISSUE GRAFT FORCEP	304
TISSUE MEMBRANE FORCEPS	304-305
TISSUE PUNCH	309
TISSUE PUNCH FORCEPS TO REMOVE TISSUE	305
TISSUE PUNCH SET OF 5 PCS	308
TISSUE PUNCH STRAIGHT & CURVED	309
TISSUE PUNCH WITH PIN SET OF 4 PCS	308
TITANIUM METAL LOCKING PLIER	304
TITANIUM PLASMA COATED PDL ELEVATORS SET OF 7 PCS ...	100
TITANIUM PLASMA COATED PDL ELEVATORS SET OF 7 PCS WITH CASSETTE	100
TITANIUM PLASMA COLOUR COATED	297
TITANIUM PLASMA COLOUR COATED IMPLANT SINUS LIFT INSTRUMENTS	288
TITANIUM PLASMA COLOUR COATED INSTRUMENTS 290-292, 295	
TITANIUM PLASMA COLOUR COATED SINUS LIFT.....	286-287, 289
TOFFLEMIRE-JUNIER MATRIX RETAINERS	231-232
TOFFLEMIRE-SENIOR MATRIX RETAINERS	231
TOFFLEMIRE-UNIVERSAL MATRIX RETAINERS	231, 232
TOMAS EXTRACTING FORCEPS (AMERICAN PATTERN)	47
TOMAS EXTRACTING FORCEPS (FOR CHILDREN)	31
TOMATI BONE ROUNGER	246

DESCRIPTION	PAGE#
TÖNNIS NEEDLE HOLDERS	221
TORQUE WRENCH & RATCHET	310
TORQUING PLIERS	268
TOWNER PERIODONTAL INSTRUMENTS	168, 171
TOWNER-JACQUETTE PERIODONTAL INSTRUMENTS	168, 171
TRELAT PERIODONTAL INSTRUMENTS	238
TREPHINE	308
TREPHINE DRILL SET OF 8 PCS	308
TRIO DENTAL SYRINGES	240
TUNNELIERUNGS INSTRUMENT	297
TWEED / ANGEL ARCH FORMING AND TORQUING PLIERS T.C	268
TWEED / ANGLE ARCH FORMING & TORQUING PLIERS	259
TWEED LOOP FORMING PLIERS	264-265
TWEED LOOP PLIER	257
TWEEZERS	106-112
TWIEL-ON ELASTIC MODULE INSTRUMENT	251
TYPE EURO DENTAL SYRINGES	240
U	
UNIQUE RETRACTOR	204
UNIVERSAL CROWN SCISSORS	211
UNIVERSAL CUT & HOLD DISTAL END CUTTER	262
UNIVERSAL DOLPHIN STYLE WIRE BENDING PLIERS	260
UNIVERSAL GUM SCISSORS	213
UNIVERSAL IMPRESSION TRAYS	330
UNIVERSAL PLIERS	259, 261
UNIVERSITY OF MICHIGAN POINTED PROBES	120
UNIVERSITY OF MICHIGAN EXPLORERS	119
UNIVERSITY OF NORTH CAROLINA	119
USC TOWNER PERIODONTAL KNIVES	176
UTILITY PLIER WEINGART TC. GOLD.	272
V	
V BENDING PLIERS	259
VEHE WAX AND MODELLING CARVERS	186
VERNIER GAUGE	279
VICKERS PERIODONTAL INSTRUMENTS	237
W	
W. BARRY ROOTS ELEVATOR	89
WAHL 1 BONE FILES	235
WAHL BONE FILE	179
WAKAI HEAT CARRIERS	125
WAKEFIELD PERIODONTAL INSTRUMENTS	237
WALDSACHS WIRE BENDING AND CUTTING PLIERS	260
WANGEN HOLDER WITH DUAL	202
WARD CARVERS INSTRUMENTS	143
WARWICK-JAMES ROOTS ELEVATOR	91
WATER SYRINGE	233
WAX AND MODELLING CARVERS	186
WAX KNIVES	188-190
WAX SPATULAS	191
WEDELSTAEDT CHISELS	145
WEINGART PLIER	259, 263
WEINGART UTILITY PLIERS T.C	267
WEINGART-MINI UTILITY PLIERS T.C	267
WEITLANDERJENNINGS RETRACTORS - MOUTH GAGS	201
WEITLANER RETRACTORS - MOUTH GAGS	201
WESTCOTT FILLING INSTRUMENTS	132, 135-136
WESTCOTT SCISSORS	210
WESTON CEMENT SPATULAS	185
WHITE PLASTIC FILLING INSTRUMENTS	134
WHITE ROOT ELEVATOR	72, 84
WIDE MATRIX RETAINERS	232
WILAND CARVERS INSTRUMENTS	144

DESCRIPTION	PAGE#	DESCRIPTION	PAGE#
WILKINS/TUFTS EXPLORER	117		
WILLIAM PROBE SET DOUBLE ENDED	123		
WILLIAMS POINTED PROBES	120		
WILLIAMS DE PROBE	118		
WILLIAMS EXPLORERS	119		
WILLIAMS POINTED PROBES	120		
WILLIAMS PROBE	118		
WILLIGER CURETTE	235		
WINTER EXTRACTING FORCEPS (AMERICAN PATTERN)	41		
WINTER ROOTS ELEVATOR	89		
WIRE BENDING AND LOOP FORMING PLIERS T.C	267		
WISDOM EXTRACTING FORCEPS	23		
WISDOM ROOTS ELEVATOR	81		
WITZEL EXTRACTING FORCEPS (AMERICAN PATTERN)	40		
WITZEL EXTRACTING FORCEPS (ENGLISH PATTERN)	24		
WITZEL ROOTS SPLINTER FORCEPS	29		
WOODSON PLASTIC FILLING INSTRUMENTS	134		
WOODWARD EXTRACTING FORCEPS (AMERICAN PATTERN)	53		
WRAP AROUND EXTRACTION FORCEP	38		
WYNMAN CROWN GRIPPER	228		
X			
X RAY FILM HANGER	230		
Y			
YOUNG TONGUE FORCEPS	217		
YOUNG WIRE BENDING & LOOP FORMING PLIERS	257		
Z			
ZAHLE WAX AND MODELLING CARVERS	186		





Smile Surgical is very well reputed Original Equipment Manufacturer (OEM) and can provide customised packaging to our valuable customers.

Please Contact Us For Special Designed Packaging



ISO 9001:2015
ISO 13485:2012



SSSMILE
SURGICAL

Manufacturer & Exporter of Surgical & Dental Instruments.

Mohalla Moallma, Head Marala Road, Machi Khokhar,
Sialkot – 51310, Pakistan
Tel: 0092 52 4265445, Fax: 0092 52 4265445
Email: info@smile-surgical.com

web: www.smile-surgical.com

Distributed By:

